

QST

August, 1937
25 cents

devoted entirely to

amateur radio

In this Issue—

**New U. H. F.
Converter**

**Portable Units
for the Station**



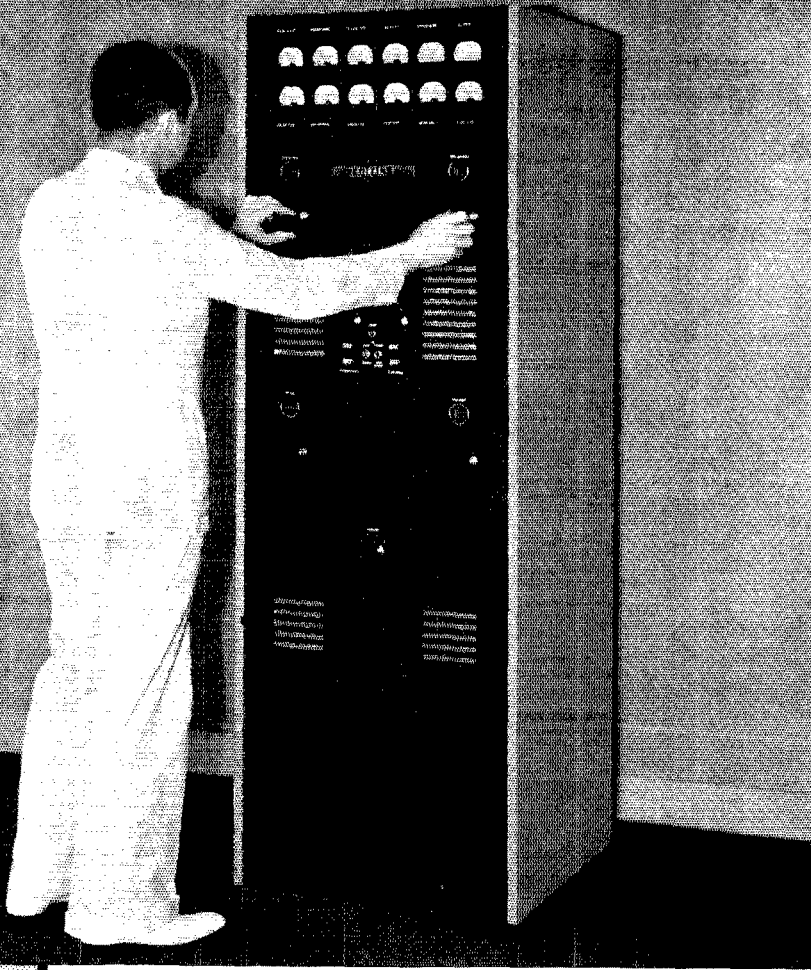

250A

For the amateur who is interested in a means of consistent radio communication there is the Collins 250A Transmitter, one of the 200 Series so widely used in various commercial services. The cost of this transmitter is low because automatic tuning is not used and expensive control circuits are eliminated, but it has the same general design and excellence of construction of the larger and more complicated 200 Series Transmitters. All parts in the 250A are easily accessible through the use of Collins demountable deck construction.

The appearance and finish of the equipment is commercial in every respect and the transmitter is free of unnecessary gadgets.

Convenient frequency change is accomplished by the use of pretuned tank circuits in the low level stages and simple plug-in coils in the output circuit. Frequency range is 1500-30,000 kc. The tube complement is low in cost, consisting of 1—C-100D Oscillator; 1—6L6 First Amplifier-Doubler; 1—6L6 Second Amplifier-Doubler; 1—6L6 Third Amplifier-Doubler; 1—CK70 Intermediate Amplifier; 2—805 Final Amplifiers; 2—C805 Modulators; 2—872 High voltage Rectifiers; 2—5Z3 Low voltage Rectifiers.

Power output of 300 watts phone and CW makes the 250A a dependable DX getter and at the same time is easy on the light bill. Very moderately priced, the Collins 250A has everything you need to do a real job.

COLLINS RADIO COMPANY
C E D A R R A P I D S I O W A

the 1938 SUPER SKY RIDER

Already hundreds of amateurs are using the New 1938 Super Sky Rider. They are testing its fine sensitivity, its wide range variable selectivity, its revolutionary New Spiral Band Spread on the air under all conditions of service. On their verdict we rest our case, so ask the amateur who owns one what he thinks of the New 1938 Super Sky Rider.

- ★ 5 to 550 Meters Coverage
- ★ 6 Bands
- ★ 11 Tubes
- ★ Wide Range Variable Selectivity
- ★ Better Than One Microvolt Average Sensitivity on All Bands
- ★ Improved Crystal Filter Control
- ★ 1000° Electrical Band Spread
- ★ "S" Meter
- ★ 1.5 Watt Undistorted Output
- ★ Air-Trimmed R.F. Circuit
- ★ Improved Expanding I.F. Transformers

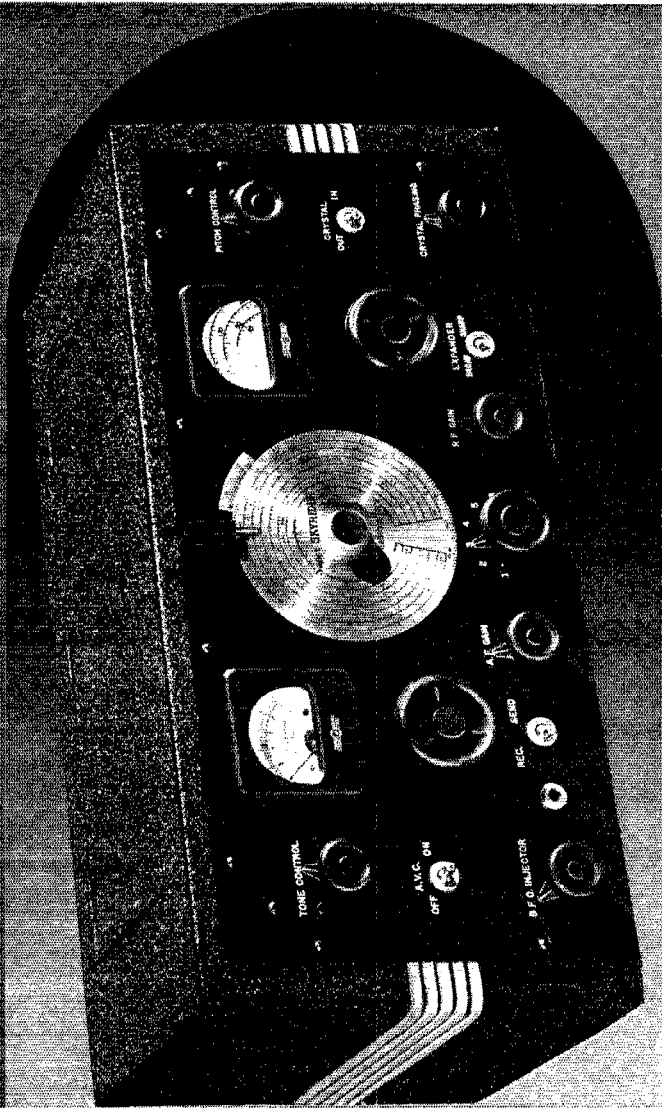

SEE THE NEW SUPER SKY RIDER AT YOUR DEALER'S OR WRITE FOR COMPLETE INFORMATION

the hallicrafters inc.

2611 INDIANA AVE., CHICAGO, U. S. A. CABLE ADDRESS "HALLICRAFT" CHICAGO

America's Leading Manufacturers of Communications Receivers

THE SUPER SKY RIDER

SEE IT! OPERATE IT! COMPARE IT!



The New 1938 SUPER SKY RIDER

You can try any new Hallicrafters' receiver for a ten day free trial period without obligation. Simply send your order for any receiver with a \$5.00 deposit. Then leave a deposit with your express agent while you try the set for ten days, which deposit he will return to you if you return the set. I will do all I can to see that you are 100% satisfied with what you get from me.

You can trade in your present receiver for a liberal allowance on a new 1938 Hallicrafters' model. You can buy on terms arranged to suit you with a minimum finance charge, and I finance my paper so the entire transaction is between you and me. Your orders and inquiries are personally attended to by Robert Henry, W9ARA, an active amateur twelve years; M.I.T. graduate E.E.; owner of Henry Radio Shop selling amateur supplies for eight years. You can reach me by letter, phone, telegram, or visit nearly any hour of the day, any day of the year. I will do all I can to give you better and more complete service than you can get elsewhere. Let me help you with your problems. Write to me for any information.

You don't have to wait until you have ready cash. Order any receiver now on Bob Henry's easy credit plan. You get the most prompt shipment of your order and my terms are simple and economical. Just send your order with two credit references and tell me what you wish about yourself.

THESE TERMS SAVE YOU MONEY, TIME, EFFORT! Please compare them with others

Model of Receiver	Cash Price	Down Payment	12 Monthly Payments
Sky Buddy	\$29.50	\$5.90	\$2.08
Sky Chief	44.50	8.90	3.15
Sky Challenger	69.50	13.90	4.03
Sky Challenger & speaker	79.00	15.80	5.58
Sky Challenger & crystal	79.50	15.90	5.62
Sky Challenger, xtal. speaker	89.00	17.90	6.28
Super Skyrider	99.00	19.80	6.99
Super Skyrider & speaker	111.00	22.20	7.84
Super Skyrider & crystal	111.00	22.20	7.84
Super Skyrider, xtal. speaker	123.00	24.60	8.69
Ultra Skyrider	99.50	19.90	7.03

Robert Henry

W9ARA

HENRY RADIO SHOP

211-215 North Main Street

Butler, Missouri

the hallicrafters inc.

QST

devoted entirely to

AMATEUR RADIO

PUBLISHED, MONTHLY, AS ITS OFFICIAL ORGAN, BY THE AMERICAN RADIO RELAY LEAGUE, INC., AT WEST HARTFORD, CONN., U. S. A.; OFFICIAL ORGAN OF THE INTERNATIONAL AMATEUR RADIO UNION

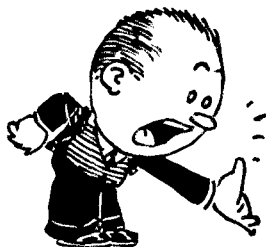

AUGUST

1937

Volume XXI

Number 8



Kenneth B. Warner (Secretary, A.R.R.L.), *Editor-in-Chief and Business Manager*; Ross A. Hull, *Associate Editor*; James J. Lamb, *Technical Editor*; George Grammer, *Assistant Technical Editor*; Clark C. Rodimon, *Managing Editor*; David H. Houghton, *Circulation Manager*; Ralph T. Beaudin, *Assistant Circulation Manager*; F. Cheyney Beekley, *Advertising Manager*; Charles Brunelle, *Assistant Advertising Manager*.

Editorial and Advertising Offices

38 La Salle Road
West Hartford, Connecticut

Subscription rate in United States and Possessions and Canada, \$2.50 per year, postpaid; all other countries, \$3.00 per year, postpaid. Single copies, 25 cents. Foreign remittances should be by international postal or express money order or bank draft negotiable in the U. S. and for an equivalent amount in U. S. funds.

Entered as second-class matter May 29, 1919, at the post office at Hartford, Connecticut, under the Act of March 3, 1879. Acceptance for mailing at special rate of postage provided for in section 1103, Act of October 3, 1917, authorized September 9, 1922. Additional entry at Concord, N. H., authorized February 21, 1929, under the Act of February 28, 1925.

Additional second-class entries to cover sectional editions authorized March 20, 1935. Copyright 1937 by the American Radio Relay League, Inc. Title registered at United States Patent Office.

The Contents

Editorials	7
Central Division Convention	8
South Dakota State Convention	8
Silent Keys	8
CQ PITC <i>Alan Eurich, W8IGQ, WCFT</i>	9
1936 Hiram Percy Maxim Memorial Award Goes to W6KFC	11
A.R.R.L. Announces August Low Power Contest	13
Battery Performance from the R.A.C. Power Supply <i>George Grammer</i>	14
A.R.R.L. Copying Bee Results	18
What the League Is Doing	19
A Unit Style Portable Station <i>Clinton B. DeSoto, W1CBD and Byron Goodman, W1JPE</i>	20
Army-Amateur Radio System Activities	26
Dixie Jones' Owl Juice	26
Naval Communication Reserve Notes	27
Northwestern Division Convention	29
Pacific Division Convention	29
A 56-Mc. Converter of High Stability <i>Byron Goodman, W1JPE</i>	30
Operating Data on the New Beam Power Tubes <i>George Grammer</i>	33
A DeLuxe 'Phone Transmitter with Grouped Controls and Cable Tuning <i>S. L. Baraf and Frank Edmonds, W2DIY</i>	37
Class-B Audio Design <i>Earl I. Anderson, W8UD</i>	43
How Would You Do It?	46
Hints and Kinks for the Experimenter An Inexpensive Time Delay Relay — Break-In Operation with a Dynamotor — Measuring R.F. Power with an Exposure Meter — Keying a 53 — Grid-Modulator Coupling	52
West Gulf Division Convention	52
New Vibrator Type Plate Supplies	52
I.A.R.U. News	53
Amateur Radio Stations	55
Operating News	56
Correspondence Department	63
A.R.R.L. QSL Bureau	74
New England Division Convention	90
New Amateur Tubes	96
Rocky Mountain Division	106
Roanoke Division Convention	106
Hamads	107
QST's Index of Advertisers	110

For the Best Results on 10 METERS!

STANDARD "SUPER-PRO"
POWER SUPPLY CHASSIS



THE NEW

STANDARD "SUPER-PRO"
IN METAL CABINET

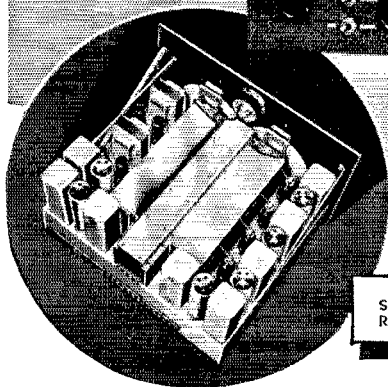

STANDARD "SUPER-PRO"
RECEIVER CHASSIS

Super-Pro

DESIGNED and built with the famous HAMMARLUND painstaking care and skill, the new "Super-Pro" provides a new, outstanding degree of efficiency on 10 meters! Using two stages of R.F. on all five bands, including the 20 to 40 mc. band, this model affords a sensitivity of 0.8 micro-volt (30% modulated) with a signal to noise ratio of 6 to 1 on 28 mc.! In addition, the image rejection ratio on 28 mc. is 150 to 1! A special electrical band spread system spreads the 28 to 30 mc. band over 90 divisions of the dial.

Other unusual new "Super-Pro" features are — direct tuning accurate to within 1/2%; calibrated bandwidth, beat oscillator, sensitivity, and audio gain controls; stand-by, A.V.C.—Manual, C.W.—Mod. switches; 8 metal and 8 glass tubes; separate humless power supply, rugged self-contained tuning unit with trouble-free cam knife switch, etc. Tuning range of 10 meter model from 1.25 to 40 mc. Model for .54 to 20 mc. range, with all of above features, also made. Either type available in crystal or standard form, for table or rack mounting.

Complete details appear in special "Super-Pro" bulletin. Mail coupon below for your free copy!

HAMMARLUND MFG. CO., INC.
424-438 W. 33rd St., N. Y. City

- Please send me new "Super-Pro" bulletin.
- Please send me new "37" catalog.

Name

Address

City..... State..... Q-8

★ SEND
FOR THIS
BULLETIN.



HAMMARLUND

Say You Saw It in QST — It Identifies You and Helps QST

Section Communications Managers of the A.R.R.L. Communications Department

All appointments in the League's field organization are made by the proper S.C.M., elected by members in each Section listed. Mail your S.C.M. (on the 10th of each month) a postal covering your radio activities for the previous 30 days. Tell him your DX, plans for experimenting, results in phone and traffic. He is interested, whether you are an A.R.R.L. member or get your QST at the newsstands; he wants a report from every active ham. If interested and qualified for O.R.S., O.P.S. or other appointments he can tell you about them, too.

ATLANTIC DIVISION			
Eastern Pennsylvania	W3EZ	James M. Bruning	339 W. Lancaster Ave. Haverford
Maryland-Delaware-District of Columbia	W3BAK	Edgar L. Hudson	Laurel, Delaware
Southern New Jersey	W3BEL	W. W. Filson	Audubon
Western New York	W8LSS	Charles Smith	Oneta
Western Pennsylvania	W8OFO	Kendall Speer, Jr.	Lowber
CENTRAL DIVISION			
Illinois	W9KJY	L. John Huntoon	327 Brandon Ave. Glen Ellyn
Indiana	W9DQ	Noble Burkhart	R. 4, Box 1 Indianapolis
Kentucky	W9AUH	G. W. Mossbarger	Box 177 Camp Taylor
Michigan	W8DPE	Harold C. Bird	R.F.D. 2 Pontiac
Ohio	W8AQ	E. H. Gibbs	300 High St. Milsworth
Wisconsin	W9ATO	E. A. Cary	3922 No. 19th Pl. Waukegan
DAKOTA DIVISION			
North Dakota	W9RZA	Ernest Bloch	Box 202 Thompson
South Dakota	W9SEB	Andrew J. Kjar	221 West Prospect Ave. Pierre
Northern Minnesota	W9IGZ	Edwin L. Wicklund	R.F.D. 3 Kensington
Southern Minnesota	W9DCM	Webster F. Soutles	3549 36th Ave., So. Minneapolis
DELTA DIVISION			
Arkansas	W5ABI	H. E. Velte	4415 West 12th St. Little Rock
Louisiana	W5DKR	Eugene H. Treadaway	2749 Myrtle St. New Orleans
Mississippi	W5CWO	H. Weems, Jr.	P. O. Box 345 State College
Tennessee	W4DEP	B. G. Lowrey Smith	673 Hillcrest St. Memphis
HUDSON DIVISION			
Eastern New York	W2LU	Robert E. Haight	511 South Holmes St. Scotia
N. Y. C. & Long Island	W2ZVY	E. L. Baunach	102 Central Ave. Massapequa, L. I.
Northern New Jersey	W2GMN	Fred C. Read	1014 North Ave. Elizabeth
MIDWEST DIVISION			
Iowa	W9NNM	Owen Williams	108 No. Johnson St. Iowa City
Kansas	W9PB	Harry E. Legler	304 Miami St. Hiawatha
Missouri	W9CTR	J. Dewey Mills	Box 205 Mount Vernon
Nebraska	W9FAM	Samuels C. Wallace	Green St. Clarks
NEW ENGLAND DIVISION			
Connecticut	W1CTI	Frederick Ellis, Jr.	19 Merrill Rd. Norwalk
Maine	W1FBJ	Winfield A. Ramsdell	1188 Washington Ave. Portland
Eastern Massachusetts	W1ABG	Albert N. Giddis	128 Crawford St. Lowell
Western Massachusetts	W1AHJ	William J. Barrett	239 Columbia St. Adams
New Hampshire	W1BET	Carl E. Evans	80 No. State St. Concord
Rhode Island	W1HRC	Clayton C. Gordon	192 Washington Ave. Providence
Vermont	W1GNF	Alvin H. Battison	1 Central St. Windsor
NORTHWESTERN DIVISION			
Alaska	K7PO	Richard J. Fox	Box 301 Ketchikan
Idaho	W7EMT	Carl Eichelberger	2810 North 6th St. Boise
Montana	W7CRH	Russell U. Richmond	Ketchikan
Oregon	W7AJV	Eugene E. Lovejoy	5013 N. E. Clackamas Somers
Washington	W7WY	Robert H. Votaw	Route 1, Box 398 Portland
PACIFIC DIVISION			
Hawaii	K6AJA	Otis Hill	Box 952 Hilo
Nevada	W6BIC	Edward W. Heim	509 Claremont St. Reno
Santa Clara Valley	W6FBW	Elbert Amarantes	454 Washington St. San Jose
East Bay	W6JTV	Harold J. Burchfield	2240 106th Ave. Oakland
San Francisco	W6SC	Sam O. Whitaker, Jr.	79 Elinor Ave. Adams
Sacramento Valley	W6GZV	J. L. C. Buckenham	2931-24th St. Sacramento
Philippines	KA1GR	George L. Rickard	Box 849 Manila
San Joaquin Valley	W6LPE	Angelo V. Astone	729 Safford Fresno
ROANOKE DIVISION			
North Carolina	W4OG	H. S. Carter	P. O. Box 111 Winston-Salem
South Carolina	W3UVA	Charles M. Waff, Jr.	2914 Monument Ave. Richmond
Virginia	W8KKG	Dr. Wm. H. Rihelddaffer	Lost Creek
ROCKY MOUNTAIN DIVISION			
Colorado	W9FA	Glen Glasscock	2164 So. Corona St. Denver
Utah-Wyoming	W7COH	Townsend J. Rigby	Midwest, Wyoming
SOUTHEASTERN DIVISION			
Alabama	W4DGS	James F. Thompson	2248 S. Arlington Ave. Birmingham
Eastern Florida	W4DVO	L. A. Connolly	712 S. Edison Ave. Tampa
Western Florida	W4BSJ	Ellis R. Curry	Box 425 Madison
Georgia-Cuba-Isle-of-Pincs-Porto Rico-Virgin Islands	*W4PM	Charles W. Davis	2136 N E Boulevard Dr. Atlanta, Ga.
SOUTHWESTERN DIVISION			
Los Angeles	W6GXM	Don M. Draper	4421 West 63 St. Los Angeles
Arizona	W6LYG	C. D. Post "Quemada"	"El Post" Post Office San Diego
San Diego	W6EOP	Harry A. Ambler	4101 Hamilton St. San Diego
WEST GULF DIVISION			
Northern Texas	W5DXA	Lee Hughes	125 N. Main St. Childress
Oklahoma	W5CEZ	Carter L. Simpson	2010 So. 4th St. Ponca City
Southern Texas	W5BTM	Ammon G. Young	4803 Ell St. Houston
New Mexico	W5CGJ	Joseph M. Eldodt	Chamita
MARITIME DIVISION			
Maritime	VE1DQ	A. M. Crowell	69 Dublin St. Halifax, N. S.
ONTARIO DIVISION			
Ontario	VE3SG	Fred H. B. Saxon	302 Lee Ave. Toronto, Ont.
QUEBEC DIVISION			
Quebec	VE2EE	Stan Comach	780 Brault Ave. Verdun, P. Q.
VANALTA DIVISION			
Alberta	VE4LX	Alfred D. Kettenbach	Rockyford
British Columbia	VE5EP	D. R. Vaughan-Smith	Vancouver
PRAIRIE DIVISION			
Manitoba	VE4BG	A. J. R. Simpson	635 Garfield St. Winnipeg
Saskatchewan	VE4EL	Wilfred Skaife	2040 McTavish St. Regina

* Officials appointed to act until the membership of the Section choose permanent S.C.M.'s by nomination and election.

The American Radio Relay League



THE AMERICAN RADIO RELAY LEAGUE, INC., is a non-commercial association of radio amateurs, bonded for the promotion of interest in amateur radio communication and experimentation, for the relaying of messages by radio, for the advancement of the radio art and of the public welfare, for the representation of the radio amateur in legislative matters, and for the maintenance of fraternalism and a high standard of conduct.

It is an incorporated association without capital stock, chartered under the laws of Connecticut. Its affairs are governed by a Board of Directors, elected every two years by the general membership. The officers are elected or appointed by the Directors. The League is non-commercial and no one commercially engaged in the manufacture, sale or rental of radio apparatus is eligible to membership on its board.

"Of, by and for the amateur," it numbers within its ranks practically every worth-while amateur in the nation and has a history of glorious achievement as the standard-bearer in amateur affairs.

Inquiries regarding membership are solicited. A bona fide interest in amateur radio is the only essential qualification; ownership of a transmitting station and knowledge of the code are not prerequisite. Correspondence should be addressed to the Secretary.

HIRAM PERCY MAXIM, FIRST PRESIDENT

OFFICERS

President.....EUGENE C. WOODRUFF, W8CMP
State College, Pa.

Vice-President.....GEORGE W. BAILEY, W1KH
Weston, Mass.

Secretary.....KENNETH B. WARNER, W1EH
West Hartford, Connecticut

Treasurer.....ARTHUR A. HEBERT, W1ES
West Hartford, Connecticut

Communications Mgr....F. EDWARD HANDY, W1BDI
West Hartford, Connecticut

General Counsel.....PAUL M. SEGAI
1010 Shoreham Building, Washington, D. C.

DIRECTORS

President
EUGENE C. WOODRUFF.....W8CMP
234 W. Fairmount Ave., State College, Pa.

Vice-President
GEORGE W. BAILEY.....W1KH
74 Webster Road, Weston, Mass.

Canadian General Manager
ALEX REID.....VE2BE
169 Logan Ave., St. Lambert, P. Q.

Atlantic Division
WALTER BRADLEY MARTIN.....W3QV
Box 612, Rostlyn, Pa.

Central Division
R. H. G. MATHEWS.....W9ZN
100 East Ohio St., Chicago

Dakota Division
CARL L. JABS.....W9BVB
1822 James St., St. Paul, Minn.

Delta Division
E. RAY ARLEDGE.....W5SI
P. O. Box 286, Pine Bluff, Ark.

Hudson Division
KENNETH T. HILL.....W2AHC
115 Willow St., Douglaston, L. I., N. Y.

Midwest Division
FLOYD E. NORWINE, JR.....W9EFC
120 South Fourth St., St. Louis, Mo.

New England Division
PERCY C. NOBLE.....W1BVR
37 Broad St., Westfield, Mass.

Northwestern Division
RALPH J. GIBBONS.....W7KV
c/o United Air Lines, Pendleton, Ore.

Pacific Division
S. G. CULVER.....W6AN
2962 Russell St., Berkeley, Calif.

Roanoke Division
H. L. CAVENESS.....W4DW
State College Station, Raleigh, N. C.

Rocky Mountain Division
EDWARD C. STOCKMAN.....W9ESA
618 So. Williams St., Denver

Southeastern Division
BENNETT R. ADAMS, JR.....W4APU
1512 Grove Place, Homewood, Ala.

Southwestern Division
CHARLES E. BLALACK.....W6GG
443 Main St., El Centro, Calif.

West Gulf Division
WAYLAND M. GROVES.....W5NW
% Humble Pipe Line, Talco, Texas

Address all general correspondence to the administrative headquarters at West Hartford, Connecticut



THE EDITOR'S MILL

IT strikes us that the 30-Mc. band isn't so entirely dead this summer as amateurs commonly believe. On several occasions recently, when no signals at all were to be heard on the tuner, we have sent out a CQ and received answers from two or three fellows. It seems that they were just sitting there, waiting for someone to call!

We suspect that too many of us have the habit of just listening briefly on the band and, hearing nothing, concluding that it is "dead to-day." Of course if we all did that, all our listening would always disclose a silent band. Moral: give 28-30 a whirl; you'll be surprised. Or, as some of our friends put it, "Ya gotta make calls if ya wanta get results."

THE telegraph code is commonly said to be made of two elements, the dot and the dash. We would like to observe that that is only two-thirds of the story. There are three elements: the dot, the dash, and *the space*. Of these, we sometimes think the space is the most important. The relative length of dots and dashes can vary over wide limits without disturbing the readability of the signals, if only the spacing is correct.

The most common sending error is bad spacing within letters, the thing that makes CQ sound too often like NNMA or NNMET. Again it is the spacing that is at fault when TEST becomes NSR.

But of all the spacing errors, the one whose correction would confer the greatest boon upon us is the failure to leave a space between words or between the repetitions of a call. Particularly when calls are run together, there is nothing to do but reduce the hogwash to paper and see where the dividing lines ought to be drawn. It takes a mind-reader to hear CIMARHCIMARHC1 on the air and realize without writing it down that somebody is calling HCIMAR in Ecuador and forgetting all about the third element of the telegraphic code, the space.

THE R scale for expressing signal strength is supposed to be dead in amateur radio. Long live the S scale!

We used to talk R1 to R9, but the time was reached when amateur radio, or at least the telegraphic portion of it, almost universally adopted the RST system of reporting signals. Under that system, R refers to readability, expressed as

QSA1 to QSA5, and so we no longer want to use R to refer to signal strength. It is the S element in RST which reports the signal strength. That is why articles in *QST* refer to strength of S5 or S9, instead of the old designations of R5, R9, etc. Of course the definitions in the two systems are not precisely the same, but they're so close that the difference can be neglected in practice.

So it's bad form now to say "R9." If that's what you mean, you should say "S9." And that goes for 'phone as well as c.w. How about it, gang?

WE seem to be unloading some operating thoughts this month. While we are at it, there is one more we might as well get off the hook:

The Q abbreviations were got up originally to permit the interchange of necessary information between operators who might not understand a single word of the other's language, and they therefore have extremely precise meanings. All too frequently these meanings are not observed in amateur radio with sufficient rigidity. We'll illustrate:

Recently we were QSO a European amateur who was using an electron-coupled oscillator. He observed that there was strong interference on us. In response we stated that, as far as that went, there was plenty of interference on him too. Then, addressing ourselves to the point, we said that we were proud possessors of a new rubber crystal and could QSY slightly if he wished. In fact, we definitely asked him "QSY?" a couple of times, complete with the question mark each time. Now "QSY?" has just one meaning, and a very definite one: it refers to whether *I*, the inquirer, should shift frequency. But what did this galoot do but come back and say OK OK, *he* would QSY. And durned if he didn't do it, too! A twist of the wrist on his good old E.C.O. and he whisked away to other parts of the band, and we never did hear him again. Again a moral: when you are talking with a foreign amateur, and there are language handicaps, observe carefully the exact assigned meanings of the international abbreviations. He probably means exactly what the Madrid bible says a particular Q combination means.

THE Army and the Navy in this country do a sterling job of supporting amateur radio when it needs support. We owe something to both

services for their backing of us. One of the things we can do to repay them is to take part in the work of the A.A.R.S. and N.C.R., according to our preferences and qualifications. It is part of the "serious" side of the game that has built amateur radio to its present strength. To spread the news of what these services are doing, we are pleased to inaugurate in this issue of *QST* two new departments, one devoted to the Army-Amateur Radio System and the other to the Naval Communications Reserve. The depart-

ments are written in the head offices of these services and we hope that each month they may tell our readers something of the interesting story that is going on behind the scenes for those amateurs who are participating.

— . . . —
*Chowpy-chowpy,
Chow-chow-pee-chow.
Something's the matter
With my radiow.*

K. B. W.

Our Cover

THE shot this month comes from Elmira, N. Y., where the annual National Soaring Contest is being held. Grant Meecker, WSADV, is shown installing an ultra-high-frequency transmitter-receiver in a Ross-Stephens sailplane. The fellow with all the parachute trappings is Harland Ross, the designer and pilot of the ship. Incidentally, the Elmira Radio Association gang did a bang-up job again this year with their communication networks between the administration buildings, the various launching sites, control points and the soaring planes. The Elmira organization is a sweetly running set-up if ever there was one.

Central Division Convention

Detroit, Mich., September 4th-5th-6th

THE Greater Detroit Amateur Radio Council is sponsoring the official Central Division Convention to be held at the Hotel Tuller, Detroit, Mich., on September 4th, 5th and 6th. It is the pleasure of the Convention Committee to extend a cordial invitation to all A.R.R.L. members and radio amateurs to attend this affair in Detroit.

Those amateurs who have attended former conventions and hamfests know that Detroit has always put on a good show.

A program has been prepared which will surpass all previous efforts, and if more information is desired write E. G. Canuelle, Secretary, Greater Detroit Amateur Radio Council, Hotel Tuller, Detroit, Mich.

South Dakota State Convention

Sioux Falls, S. Dak., September 4th-5th

IT IS a number of years since the last convention was held in this city, but it is the intention of the Sioux Falls Amateur Radio Club to make up for the intervening years. So, take note Ye Hams that you are all invited to attend the South

Dakota State Convention, at the Hotel Cataract Sioux Falls, S. Dak., September 4th and 5th.

The registration will begin at 10:00 A.M. on Saturday the 4th, and the fee will be kept under \$2.00 if possible. Plenty of entertainment will be in order and a feature skit by four talented members of the club will be presented during the convention.

Come early, fellows, and write Lloyd Angle, Secretary, 317 So. Menlo Ave., Sioux Falls, S. Dak.

Silent Keys

IT IS with deep regret that we record the passing of these amateurs:

John R. Eachus, ex-W3BFG, Chester, Pa.

Harry E. Hurley, W6QF, North Hollywood, Calif.

Raymond P. Mathison, W9VL, Gladstone, Mich.

Strays

W6JVJ claims the distinction of being the first mobile radio station to cross the new Golden Gate Bridge.

— . . . —
Add to unusual requests from the uninitiated: A chap wanted to know if W8PLR could spare one of his license plates. Inquiry developed that what the friend wanted was a QSL card!

— . . . —
Suggestions still come in on that slippery bug problem. Several have suggested the old stunt of moistening the feet (one fellow recommends wine!) but here's one which is supposed not to smear or scratch the surface of the table. Take the glaze off the feet with fine sandpaper, apply some glycerin and then wipe off with a cloth. W9MTC guarantees she'll stick.

CQ PITC

By Alan Eurich,* W8IGQ, WCFT

Back in 1930, when Ross Hull was returning from Australia to this country, the cargo ship on which he was one of half a dozen passengers, passed close enough to Pitcairn Island to allow a glimpse of that Pacific paradise. Hull was in the radio room when the open background of static was broken by a raspy spark signal, sending blind and asking that the boat stop at the island to swap shirts, medicines, etc., for fruit. As a result, the boat turned about and waited a couple of miles off shore while the islanders rowed out en masse in two large multi-oared boats bringing with them quantities of the most luscious fruit anyone ever heard about. The story of Andrew Young and his unique radio rig intrigued us all and several exchanges of letters were made with Pitcairn in the attempt to get the full story. Now we have it from a ham who actually lived there for a week and served time as assistant op. It isn't exactly our brand of ham radio but it is as interesting a true story as has come down the pike in many a moon.—EDITOR

WHAT old timer doesn't remember the buzzing sound of the old spark transmitter? What memories would come back to anyone who had heard this sound if he caught that same familiar note in this modern day and age! Down in the South Pacific there is just such a signal on the air. On a high island of steep, rocky cliffs, half way between Panama and New Zealand, miles from anywhere PITC is the only active radio station. This is the now famous Pitcairn Island, a British possession, to which so much attention was attracted by the motion picture, "Mutiny on the Bounty." For it was to this island that Fletcher Christian and his little band of mutineers with their Polynesian wives came back in 1790 to found what they hoped would be a home, though in exile. The island was ideal to further their ends as it was isolated from the rest of civilization, it was abundant in all kinds of fruit such as oranges, limes, mangoes, bananas, coconuts and guavas, and the climate, because of its mildness, favored an easy South Sea exist-

second world cruise came on January 31st. As radio operator on the *Yankee*, WCFT, I was interested in any radio that I met in the course of the cruise. Since the *Yankee* remained—or at least part of her crew did—for the better part of a

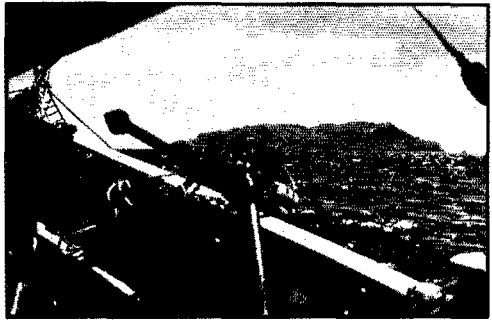

PITCAIRN ISLAND FROM THE "YANKEE"



Photos by Edmund Zacher

ANDREW YOUNG AT PITC

ence. The inhabitants of Pitcairn to-day are descendants of these mutineers and their Polynesian wives and still live the simple life of their forefathers.

It was to this island the Yacht *Yankee* on her

* Aboard Schooner *Yankee*, WCFT, on a world cruise.

week on Pitcairn, I had ample opportunity to become well acquainted with such radio as was there, for during my stay I was the guest of Andrew Young, chief radio operator for Pitcairn radio or PITC.

Those who have pounded brass in the run between Panama and New Zealand, particularly for the New Zealand Shipping Company or Shaw Savill, may have heard this station, as occasionally the ships of these lines call here. However, as the high cliffs do not permit an easy landing—the islanders are noted for their skill and daring in coming out through the breaking surf in open boats—these operators would have no chance to get ashore during the time that their ship was hove to offshore.

PITC is situated in a small one-room shack adjacent to the home of Andrew Young in Adamstown, the only village on the island. The shack overlooks the sea on one side and the island towers up over it on the other. Around it are palms, frangipani, and other tropical plants. While Andrew Young is chief operator and has charge of the station, he has a number of assistants who

help him stand the long hours of watch kept by this station, for even though PITS is in this isolated part of the world, it is regularly open around noon and again from 4 P.M. until midnight.

In the early 1920's several of the islanders started to learn the code with the aid of flashlights on the understanding that the Marconi Company would shortly send them a receiver. As their proficiency increased they graduated to a buzzer and started to study the technical side of radio. They had very few books, mainly such as "A Layman's Introduction to Radio." By this time the receiver promised to them by the Marconi Company had arrived and been installed. Necessarily it was the simple crystal receiver of its day.

In 1928 a young man came from New Zealand and installed a small spark transmitter, inevitably of low power as there was no electrical power system on the island. Who this person was is unknown, but from what I have heard of him he very likely was one of New Zealand's amateurs at that time. As the only stations within range of this small spark transmitter were ships, all operation was limited to 600 meters. The transmitter received its power from a 12-volt storage battery, or accumulator as it is known locally. Originally this was charged by a gasoline-driven generator. At that time a supply of petrol was obtained from a cache left on Pitcairn by an Italian company that had proposed to establish an air route from South America to Easter Island, Pitcairn, Manga Reva and Tahiti. When this scheme fell through, the islanders bought up the gasoline for their own use. However when this fuel was exhausted, they were unable to obtain more because of shipping regulations. To-day PITS's one battery has to be sent to New Zealand for charging. For this reason there are long periods when the transmitter is silent, but even during these periods the operators continue to keep watch.

PITS is of great importance to the Pitcairners because it brings them the information of when ships expect to call and what their needs are. These ships are their only communication with the outside world and their only source of income. To-day the equipment is very much the same as when it was first installed. The transmitter is the same old 12-volt spark coil; the receiver a Mar-

coni 16-crystal set and a Marconi 34-crystal set, but the 16 is much preferred by the operators.

During my stay on the island I pinch hit as second operator because several of Andrew's assistants were away for a few days on board the *Yankee*. I was introduced to some rather unusual customs connected with the Pitcairn radio. Days go by with hardly a sound, but even under these discouraging conditions, watch is kept when a ship is suspected of being within 1,000 miles. One day while hoping to hear GLYQ (S.S. *Rotorua*) Andrew heard GLYQ and GSXW (S.S. *Rangaiiki*) working about noon. Around 5 o'clock I relieved him and about half an hour later, was startled to hear out of dead silence a station start up calling PITS. This station quickly proved to be GLYQ. Though he was unable to hear us, he sent blind the message that Norris Young, a Pitcairner who had been to Panama for medical aid, was aboard and

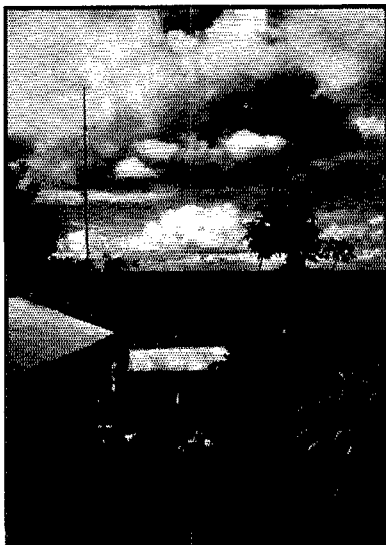

LOCATION OF PITS
Shack is in the center with antenna pole
and house at the left.

in good health and to please bring fruit for the ship and honey for Captain Lamb. Expected arrival time 6 A.M. the next morning.

I immediately called Andrew and gave him the message. Being strange to the procedure at Pitcairn, I had no idea to whom it should be delivered as there was no address. He told me that in true Pitcairn style, I should have to call "Sail ho!" at the top of my lungs. When I did so the call was taken up all over the island. Very quickly a crowd gathered around the station and after the proper authorities had been informed, a community meeting was held to arrange for gathering the fruit and loading it into the open boats.

At dawn the next morning we went out in the open boats through the breakers to meet the *Rotorua*, GLYQ, about two miles at sea. During my short visit with the operator on board, I was surprised to learn how little he knew of PITS and he was very much interested to hear what I had to tell him of my experiences ashore. He realized that Andrew would not tell him of all the difficulties that were encountered on Pitcairn.

Andrew Young's achievements at Pitcairn are very unusual. Though the equipment he has to work with would be considered impossible in most people's eyes, he has made it perform quite creditably. With his simple crystal receiver he can hear ships within 1,000 miles of the island and has

(Continued on page 70)

1936 Hiram Percy Maxim Award Goes to W6KFC

THE February, 1937, issue of *QST* bore an announcement of the creation of a permanent annual Hiram Percy Maxim Memorial Award, established in honor of their father by his daughter and son, Mrs. John G. Lee and Mr. Hiram Hamilton Maxim. This award is to be given annually to that member of the League under twenty-one years of age who is believed to have made the greatest individual contribution to amateur radio, or who has the best all-round record, during a given year.

It was stated that, in future, arrangements will be made late each year for choosing the winner so that he may be announced early in the new year. For 1936, however, owing to the fact that the award was not announced until the year had ended, this procedure was not possible, and it was not until June 23rd that the winner for the past year was announced.

The 1936 Hiram Percy Maxim Memorial Award winner is Victor H. Clark, W6KFC, of Phoenix, Ariz. He was chosen as the year's most outstanding young amateur from a sizeable group of nominations made by the S.C.M.'s of various A.R.R.L. Sections, by a board of judges consisting of the amateur members of the League's headquarters staff. In accordance with the announced terms of the Award, he will receive a bronze replica of the original "Wouff Hong" and the sum of one hundred dollars in cash.

W6KFC's selection was based on an exceptional all-round record, rather than on any single remarkable achievement. His career demonstrates an intensive, aggressive application to amateur radio, with a high degree of useful accomplishment, especially in communications and traffic-handling activities. Combined with a splendid radio record is one of courage and spirit in overcoming heavy obstacles in life's pathway.

W6KFC was born in Falmouth, Mass.,

on Cape Cod, August 23, 1917. Five years thereafter his family moved to Phoenix, Ariz., where they have remained ever since.

His schooling has, of necessity, been taken in a succession of spurts and pauses. At the conclusion of his third grade work he became ill and was forced to lose a year—regained two years later, however. When he was nine years old his father



MRS. JOHN G. LEE (PERCY MAXIM) AND HIRAM HAMILTON MAXIM, DAUGHTER AND SON OF HIRAM PERCY MAXIM, FOUNDERS OF THE MEMORIAL AWARD

died, and he was forced to assume a share of the family responsibility. After graduating from grade school in 1931 he was forced to miss three years more because of illness, not entering high school until the autumn of 1934.

It was during this period of illness, while in a weakened condition, that he took up radio. Prior to that, from the time he was ten years old, model airplane building had been his favorite hobby, and he worked part time in a model airplane shop; some of his happiest memories are of those days.

Started in radio, however, he progressed rapidly through the b.c.l. DX and s.w.l. stages, and in October, 1933, received his first operator's ticket. During the latter part of the following January he received his call. In the period between then and middle June of this year he has had approximately 5500 QSO's, handled over 10,000 messages (A.R.R.L. count), made the B.P.L. ten times, and operated 1210 days out of 1235!

To list all the individual accomplishments of his amateur career in tabular form would occupy several pages of *QST*. To mention just a few: In



VICTOR H. CLARK, W6KFC, 1936 WINNER OF THE MAXIM MEMORIAL AWARD, AT HIS HOME IN PHOENIX

1934 he placed second in his club's low-power DX contest, using 2 watts to a c.c. type 30, working all U. S. districts except W3 and W4, and VE5. In the 1935 Sweepstakes he placed high for Arizona with a score of 24,786. From May 15 to June 15, 1936, he kept nine daily skeds with the temperature over 100°, averaging 15 QSO's a day and handling 1110 messages. The same year he was W.A.S., was high in the 8th C.A. in an A.A.R.S. ZAG contest, and placed second nationally in the 1936 Sweepstakes. From Dec. 16, 1936, to Jan. 15, 1937, he piled up his highest traffic total: 1678 messages. In 1937 he won the WLM speed contest for the 8th C.A. with a speed of 50 w.p.m., was second national high in the year's first O.R.S. Party, served as "vigilante" station during the Ohio flood emergency, and then won the April O.R.S. Party with a total of 41,724 points, covering 118 QSO's with 49 Sections—the first time

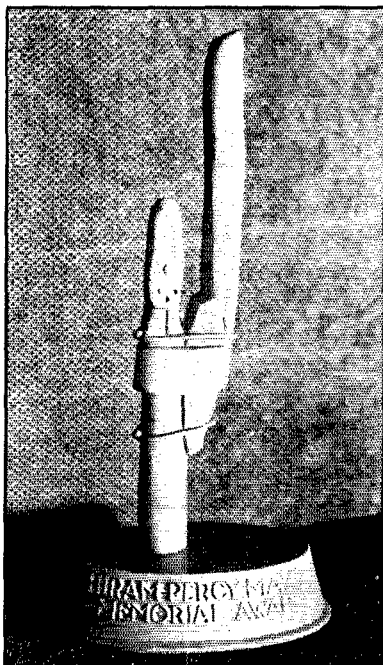

THE TROPHY, A MINIATURE OF T.O.M.'S WOUFF-HONG

was done by Albert Hinlian, young sculptor of Newington, Conn. Cast of bronze, and standing 8½ inches high, it is a faithful reproduction, even to the hammer marks and other little irregularities, of the original.

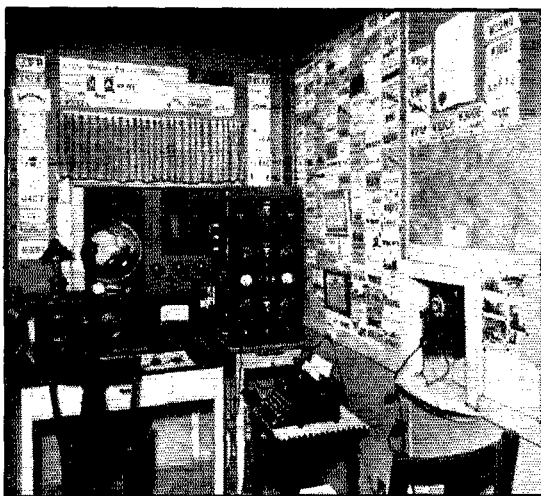

THE LAYOUT AT W6KFC

At the right of the globe is the 3.5-Mc. rig, using 47-46-10 with 50 watts input. The rack-panel job works all bands. It has the old familiar 59-59 "universal exciter," with a 10 driving a 35T to between 100-150 watts input. The output stage is a recent addition, replacing a pair of 10's. Four 866's in a bridge circuit provide high voltage. The antenna used is a 40-meter single-wire-feed type, with an end-fed Marconi in reserve.

any West Coast operator ever topped the list.

The remarkable thing about this last feat—and, indeed, almost all his radio accomplishments—is that he was not only going to school but holding down a job copying press for KOY at the same time. He works there in the mornings from 5:00 until 11:15 A.M., attends high school in the afternoons, and hams the rest of the time. To win the April Party he had to sleep Sunday and then go to work and school the next day without having slept that night.

In addition to traffic-handling, W6KFC's radio activities include some 56-Mc. work (he and W6GZU took first place in the hidden five-meter transmitter hunt at the Third Arizona Hamfest) and a certain amount of DXing. The latter includes an 80-meter QSO with J2LO, who gave him an S6 report.

Going over to the personal side, W6KFC, not yet twenty, is six feet, four inches tall, and weighs 205 pounds. He guesses that it was just a case of too much radio that wore him down to what he is now!

He lives alone with his mother—"whose generosity and patience made my 5000 QSO's possible"—and the two cats. One of them—Niggie, the favorite station mascot—is black as sin. Vic's other interests include playing at tennis and the uke. He enjoys swimming, softball and other sports. He likes the movies, but would sooner handle traffic. Then, of course, he is interested in his px job, and likes that a lot. He plans to begin study on Radiotelephone 1st and Radiotelegraph 2nd tickets as soon as he hears from Washington on the outcome of his Class A exam, recently taken.

Well, there he is—a fine, upstanding kind of young amateur, just the type that T.O.M. most approved. His is a fitting first name to engrave on the scroll of those who typify the everlasting heritage of honor and achievement left by our founder-president.

—C. B. D.

A.R.R.L. Announces August Low Power Contest

25 Watt Power Limit—Multipliers for Self-Powered Equipment—Stations Home or Field Operated—For All W/VE Stations; August 21st—22nd

THE purpose behind this activity, as the case with our June Field Day, is to encourage the building and testing of economical self-powered equipment suitable for work in possible future emergencies. Equally important is the conversion of existing stations for continued reliable operation as soon as power fails. The name of the low power man is legion, and we believe it is time we dedicated an activity to this whole group of operators, with a fair limit that does not invite competition from high-power stations. High power has its place in club emergency community plans. The more widespread availability of portables, economical in first cost and operation, but highly practical equipment in this power class, throughout the entire fraternity is the immediate objective. *Entries of all amateurs using not more than 25 watts are most cordially invited, whatever your present power supply.*

The contest set up especially focuses attention on plans for quick conversion of exciter units and receiver power supplies so that existing superlative amateur station equipment can be quickly made self-powered in any time of need, ready for any call to serve the community welfare. Experience with one temporary receiver in a crisis causes us to recommend plans to keep the regular good receiver (with which the operator is familiar, and performance superlative) going if at all possible in one's station. Emergency power is sometimes required at a home location, so home locations are permissive this time. Field installations (like June) are of course equally welcome. All such will be identified in our report of results, listings of home and field stations being kept separate, but while the June "F.D." is designed for groups, and many units may be used at one station, this August work is limited to use of one receiver and one transmitter at a time, by one or several individual operators. Power from commercial mains can be used, but of course will not justify application of the multiplier designed to credit the extra effort or expense entailed in setting up self-powered stations. Advance entry is not required. No transmitter may be entered or contacts reported that utilized more than 25 watts input to the final amplifier.

The object of the contest is to work as many other stations as possible in the allotted time. Each station worked between Saturday, August 21st (4 p.m. local time) and Sunday, August 22nd (7 p.m. local time) will count *one point*. An extra credit of 10 points, before multiplier, may be claimed for sending not more than one message, addressed to A.R.R.L., reporting your transmitter tube line-up and power supply equipment. The sum of claimed points may be multiplied by 1.5 if *either* the receiver or transmitter is self-powered, or by 2 if *both* transmitter and receiver are supplied from an independent local source. Any frequency bands may be used, and voice or c.w. telegraph.

The log of operation, claimed score, and data on power, frequency band, and time of each contact must be listed with the computed total score, and sent in promptly at the end of the tests with information on both transmitter and receiver power sources. For any credit for the message, copy must be submitted showing complete handling data, and the word count (CK) must be right and preamble in correct order.

The modern amateur station is one that is *prepared*, where recognition has been given to some means of operation to continue useful communication performance in spite of commercial power failures. Get emergency power now, if you haven't any. This is the opportunity to give a real operating test to the low power rig and see if it and the power supply stand up. The popular June Field Day emphasizes group preparedness, cooperation and planning in making group installations, and operator training. This August activity again invites Field Day boosters to go afield but to decentralize activities to individual stations within the group. The whole amateur fraternity is invited to participate with individual stations (25 watts or less) and any power source desired, while finding out just what can be done with this power. A pleasant surprise is in store for some! All amateurs are requested to put station units under the microscope, investigating ways and means of going self-powered economically and practically. New plans for A.R.R.L. Emergency Coördinators will be announced in the future. The League's Emergency Corps is open to any amateur. Registration of your self-powered facilities is invited. Try the August Low Power Contest at home or afield. It's a brand-new kind of fun. When reporting, ask us to send you the registration form for A.E.C. membership.

—F. E. H.

Battery Performance from the R.A.C. Power Supply

Voltage-Regulated Power Packs for Receivers, Speech Amplifiers and Small Oscillators

By George Grammer*

THE a.v.c. principle is proving to have an ever-widening circle of uses in radio equipment, as its application to speech-amplifier systems will attest. Another highly-practical use to which it has been put in recent months is that of regulating the output voltage of power supplies, where, by giving well-nigh perfect performance from the standpoint of maintaining constant voltage under varying loads and line voltages, rectifier-type power supplies can be designed to duplicate battery performance—but without the life factor. To the amateur, this means the elimination of the principal cause of the instability which afflicts most high-frequency receivers operating from line power. It is a real pleasure to operate a receiver whose high-frequency oscillator will “stay put” on the peak of a crystal filter regardless of the setting of the r.f. gain control and which will ignore entirely the swooping line voltage caused by switching on refrigerators, oil

reference to Fig. 1. A high-gain voltage amplifier tube (usually a sharp-cutoff pentode or tetrode) is connected in such a way that a small change in the output voltage of the power supply causes a change in grid bias and thereby a corresponding

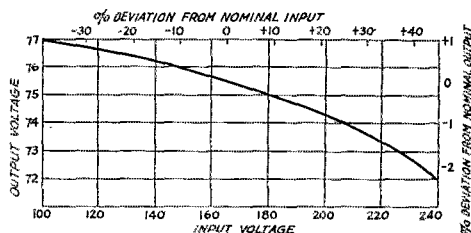

FIG. 2—OUTPUT VOLTAGE VS. INPUT VOLTAGE WITH OUTPUT SET AT 75.5 VOLTS

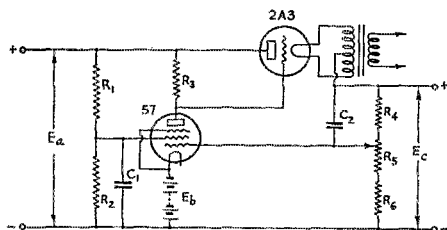

FIG. 1—ADAPTATION OF RCA VOLTAGE REGULATING CIRCUIT

This regulator system may be added to any existing power supply of the receiver type. Constants are as follows:
 C_1 —0.25 μ f.
 C_2 —1 μ f.
 For 250 volts or less d.c. input: R_1 —100,000 ohms.
 R_2 —50,000 ohms.
 R_3 —2 megohms.
 R_4 —100,000 ohms.
 R_5 , R_6 —50,000 ohms.
 E_b —22.5 volts.
 For more than 250 volts d.c. input: R_1 —150,000 ohms.
 R_2 —50,000 ohms.
 R_3 —2 megohms.
 R_4 —100,000 ohms.
 R_5 —50,000 ohms.
 R_6 —25,000 ohms.
 E_b —45 volts.

burners or the like. The usefulness of a constant-voltage supply for frequency meters, low-power oscillators and similar devices is likewise obvious.

OPERATING PRINCIPLES

The principle upon which the voltage-regulator operates is fairly simple, and can be explained by

* Assistant Technical Editor.

change in plate current. The plate current flows through a resistor (R_3) the voltage drop across which is used to bias a second tube—the “regulator” tube—whose plate-cathode circuit is connected in series with the d.c. line. The regulator tube, therefore, functions as an automatically-variable series resistor in the power supply. Should the output voltage increase slightly, the bias on the control tube becomes more positive, causing the control-tube’s plate current to increase and the drop across the plate resistor to increase correspondingly. The bias on the regulator tube, therefore, becomes more negative and the effective resistance of the regulator tube increases, causing the terminal voltage to drop. A decrease in output voltage causes the reverse action. The time lag in the action of the system is negligible and, given proper constants, the output voltage can be held within a fraction of a per cent of the desired value throughout the useful range of load currents and over a wide range of line voltages.

An essential in the system is the use of a constant-voltage bias source for the control tube. The voltage change which appears at the grid of the tube is the difference between a fixed negative bias and a positive voltage which is taken from the voltage divider across the output. To get the most effective control, the negative bias must not vary with plate current; furthermore, it is de-

sirable to use as much negative bias as possible so that the variations will be large. For example, let us assume that the fixed negative bias on the control tube is 40 volts, and that the voltage between grid and ground (negative of power supply) is 37 volts. The net bias between grid and cathode is then $-40 + 37$ volts, or -3 volts.

Now suppose the output voltage drops 10 per cent with an increase in load. The drop will be 10 per cent at any point along the divider, assuming constant conditions, so that the voltage between grid and ground is now $37 - 3.7$ volts, or 33.3 volts, leaving the net grid voltage equal to $-40 + 33.3$, or -6.7 volts, a change of 3.7 volts from the original value. If, initially, the fixed bias had been 10 volts and the drop between grid and ground -7 volts to give the same -3 -volt bias figure, a 10 per cent change in output voltage would drop the grid-to-ground voltage to 6.3 volts and the net grid voltage change would have been only 0.7 volts. Obviously, therefore, to get the most effective control it is desirable to use a relatively large value of fixed bias so that the percentage changes in output voltage will cause relatively large differences between the fixed bias and "bucking" bias.

A PRACTICAL SYSTEM

The circuit diagram of Fig. 1 is an adaptation of a regulating system used in a commercial power supply manufactured by RCA for speech amplifiers. This circuit and the performance curves of Figs. 2 and 3 were furnished by an experimenter who prefers to remain anonymous. The chief departure from the RCA circuit is in the use of a battery to bias the control tube, which is a 57, instead of an 874 gas tube. For low-voltage supplies, where only a 22.5-volt battery is required, the battery is cheaper than the 874 and its voltage is probably more constant. The life should be long, since no current is taken from the battery.

In Fig. 1, the output voltage from a regular power pack is applied to the left-hand terminals,

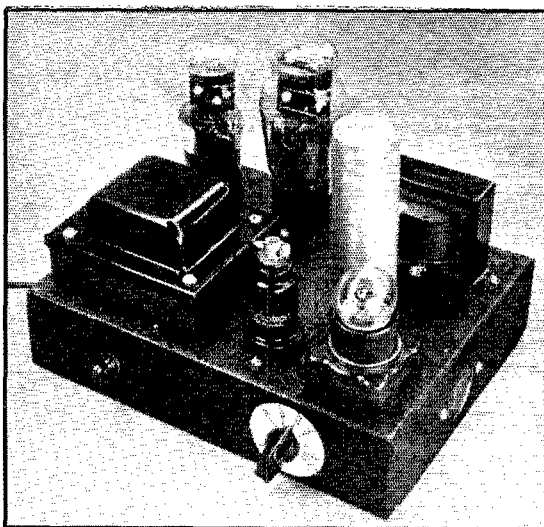

A VOLTAGE-REGULATED POWER SUPPLY FOR VOLT OUTPUT

This unit, which can be built inexpensively from standard parts, will deliver up to 70 milliamperes at any desired voltage between 160 and 250, with but a volt or two change over the whole output-current range. Line-voltage variations also are compensated for. The chassis is 7 by 9 by 2 inches. Output voltage can be set at any desired value between 160 and 350 volts by means of the control, although above 250 volts the output current is limited.

the regulated voltage being taken at the right. Resistors R_1 and R_2 constitute a voltage divider for the screen of the 57 control tube; R_3 is the 57 plate resistor which biases the grid of the 2A3 regulator tube. The bias battery, E_b , is in the position usually occupied by the cathode resistor. R_4 , R_5 and R_6 form a voltage divider across the output circuit, with R_5 variable so that the operating bias on the 57 can be set manually. This control has no effect on the automatic operation of the circuit; its function is to set the output voltage at any desired value within the operating range as determined by the circuit constants and the tubes used.

The curves of Figs. 2 and 3 are typical of the regulation to be expected. In Fig. 2, the output voltage was set at 75.5 volts and the input volt-

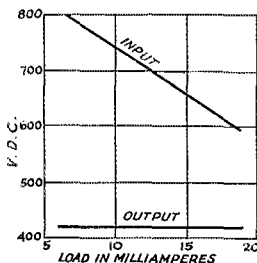

FIG. 3—OUTPUT AND INPUT VOLTAGE VS. LOAD CURRENT

age, E_a , varied. Over a 2-to-1 range of E_a , the output voltage variation was less than 1 per cent, which by practically any standards is excellent voltage regulation. Under the conditions shown graphically in Fig. 3, the voltage regulation over the current range considered was approximately $\frac{1}{4}$ of 1 per cent, too small to show on the curve.

For any particular operating conditions, satisfactory resistor values can be found through the use of the following equations:

$$\frac{R_2}{R_1 + R_2} = \frac{E_b + 90}{E_a}$$

$$\frac{R_6}{R_4 + R_5 + R_6} = \frac{E_b - 30}{E_c}$$

$$\frac{R_6}{R_4 + R_5 + R_6} = \frac{150}{E_c}$$

In all cases, maximum contemplated values of E_a and E_c should be used. E_c cannot exceed 70 per cent of E_a . The equations give ratios for the re-

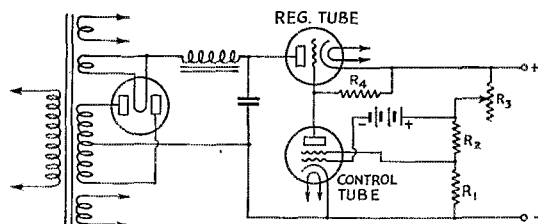

FIG. 4—ESSENTIAL CIRCUIT OF THE W.E. VOLTAGE-REGULATED POWER SUPPLY

The regulator tube is a 2A3, the control tube a 24-A. R. C. Chouinard, W9FI, suggests the following values for 300-volt output: R_1 , 20,000 ohms; R_2 , 10,000 ohms; R_3 , 100,000-ohm variable; R_4 , 250 ohms multiplied by the 2A3 cut-off bias; input choke, 20 henrys; filter condenser, 8 μ f.; transformer should give about 550 volts each side c.t.

sistances; the values used should be such that at least 2 milliamperes will flow through R_1 - R_2 , and more than 0.1 milliamperes through R_4 - R_5 - R_6 . Also, E_b , the bias battery voltage, should be more than 10 per cent of the maximum output voltage expected, for good regulation.

THE W.E. REGULATED POWER SUPPLY

The circuit of a voltage-regulated power supply recently developed by the Bell Laboratories¹ is shown in Fig. 4. The circuit arrangement is somewhat different, although the operation and results attained are similar. Plate and screen voltage for the control tube are taken from the output side instead of the input, as in Fig. 1, while the bias battery is placed in series with the lead to the grid of the control tube, a 24-A. A single-section choke-input filter is connected to the output of the rectifier; this amount of filter is ample because the voltage regulating system in itself is an excellent filter, smoothing out ripple as well as slower voltage variations. R_3 is the output voltage control; in the Bell supply the output voltage can be varied between 130 and 250 volts by means of this control.

One important characteristic of a voltage-regulated supply is that it has a very low effective output impedance, being similar to an inverse feed-back amplifier in this respect. It is, therefore, unlikely to give undesirable back-coupling in high-gain amplifiers, a common trouble with ordi-

¹ Truckess, "Regulated Plate Supply," *Bell Laboratories Record*, May, 1937.

nary power supplies. A voltage-regulated supply is consequently a good thing to have on low-level speech amplifiers.

A HAM VERSION

To most amateurs, the idea of using batteries in a line-operated power supply is a bit incongruous. To get something which would be free from the bulk and necessity for renewal that batteries entail, therefore, we hatched out the circuit of Fig. 5, which is a combination of the two foregoing, and gave it a trial. This one is built around the well-known constant-voltage properties of the ordinary neon lamp, which is a cheap replacement for the 874. A trial of the circuit in a haywire set-up convinced us that the idea was practical enough, so, after the most suitable circuit constants had been determined experimentally, the complete supply shown in the photograph was constructed.

In all these systems the fundamental principle is that of "lossing"; that is, the power supply without regulation must be capable of furnishing more voltage than is wanted at the output, under any and all conditions. The regulator cannot add anything to the output; it can only hold down excess input. In this it is similar to all a.v.c. systems. Therefore, the first requisite is a power transformer which will give, under full load conditions, at the lowest line voltage likely to be encountered, the desired output voltage plus the minimum drop through the regulator tube. The most suitable regulator tubes are triodes having low plate resistance, and of those available the 2A3 comes nearest to being the ideal. Allowing 60 or 70 milliamperes per 2A3, the lowest possible tube drop is at zero bias. The grid of the tube cannot be swung positive in this application, because the voltage drop across the control tube's plate resistor, R_5 in Fig. 5, cannot reverse in polarity. The limiting condition is zero bias, attained when the plate current of the control tube, a 6J7, is completely cut off. At zero bias, the drop between plate and cathode of a 2A3 at 70 milliamperes is approximately 70 volts. It is best to figure on a minimum drop of about 100 volts through the regulator tube, however, because at very low control-tube plate currents the neon tube is likely to extinguish, thereby destroying the control. While the neon is conducting, the voltage drop across the lamp is approximately constant at 65 volts.

Since a considerable voltage drop has to be tolerated, and since we wanted to get as much output as possible from a standard b.c.r. type transformer, a condenser-input filter was used in the unit pictured. Further to increase the output voltage, an 83-V low-drop rectifier was used in place of the customary 80. The net result is that at the full-load rating of the transformer, 70 milliamperes, a regulated output of 250 volts can

be secured. The output control, R_3 , gives a range from 160 to 365 volts; the output current is limited at the higher voltages, but at 200 and below considerably more than the rated current can be taken without losing control.

A transformer with two filament windings in addition to the rectifier winding is a requisite unless one wants to install a separate filament transformer for either the regulator tube or the control tube. In this case the transformer used has a 2.5-volt winding and a 6.3-volt winding; the former supplies the 2A3, while the latter handles the control tube and the receiver or whatever device is used in conjunction with the supply. Transformers with two 2.5-volt windings are also generally available, in case the receiver uses 2.5-volt tubes. In such case a 57 can be substituted for the 6J7.

The neon lamp is the 1-watt G-10 type, the 1-watt size being used simply because the common half-watt size is not recommended, according to the manufacturers, for d.c. For good regulation, it is essential that the resistor be taken out of the base, or else that one of the lamps without a base resistor be secured. The cement holding the base to the bulb may be softened with boiling water or a gas flame. If the resistor is left in, the regulation is considerably better than that of the power supply alone, but not nearly as good as when the resistorless lamp is used.

There are no particular "tricks" to be observed in getting the thing to work. As we have already said, the values given in Fig. 5 are the ones we found best in practice. R_5 may be made as low as 0.1 megohm; lowering the resistance will increase the range of control with varying loads, but does not give quite as good regulation as a half megohm. With the latter, the variation in output voltage from zero output current to 70 milliamperes is of the order of a volt or two — scarcely perceptible on a 500-volt meter, while the lower value of R_5 shows a change of 7 to 10 volts under the same conditions. Most of the change takes place between 0 and 25 milliamperes, however, so that there is very little practical difference when used with the ordinary receiver which has a fairly high minimum current.

The regulating capabilities of the supply depend to a considerable extent upon the output voltage selected. With constant line voltage (115 volts) the output will stay under control from zero output current up to the maximum limits:

Output Voltage	Max. Output Current
350	35 ma.
300	50 ma.
250	75 ma.
200	95 ma.
160	over 100 ma.

Line voltage variations, as well as output current variations, are compensated for to the extent to which the transformer is capable of supplying the excess voltage required. At 250 volts output, the voltage will stay constant over a range from 108 to 135 volts (the maximum available from the Variac used for this test). At 200 volts output, the same thing is true over a range of 100 to 135

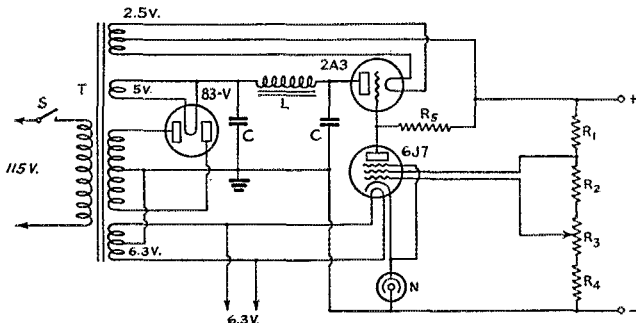

FIG 5—WIRING DIAGRAM OF A PRACTICAL VOLTAGE-REGULATED SUPPLY SUITABLE FOR RECEIVERS, SPEECH AMPLIFIER OR DEVICES HAVING COMPARABLE VOLTAGE AND CURRENT REQUIREMENTS

C—Double 8- μ fd. dry electrolytic, 450-volt working (Aerovox).

L—12 henrys, 75 ma. (Thordarson T-4707).

R_1 —10,000 ohms, 1 watt.

R_2 —25,000 ohms, 1 watt.

R_3 —10,000-ohm potentiometer (Yaxley Y10MP)

R_4 —5000 ohms, 1 watt.

R_5 —0.5 megohm, 1 watt.

N—1-watt G-10 neon bulb with base resistor removed.

T—Power transformer, 350 volts each side c.t., 70 ma.; 6.3 volts at 3 amp.; 2.5 volts at 4 amp.; 5 volts at 2 amp.

(Thordarson T-7021.)

A 6C6 may be substituted for the 6J7 if desired.

volts on the primary, and at 180 volts, over 90 to 135 volts. Momentary variations (such as caused by switching on a motor or similar operation which causes a current surge and a resultant dip in the line voltage) can occur over a much wider range without affecting the output voltage because enough energy is stored in the filter condensers to bridge such a short gap.

The neon tube is a visual indication of control, since the voltage is regulated so long as the tube glows. If the supply is used on a receiver and the load current increased or line voltage dropped to the point where the bulb goes out, there will be a click and a perceptible hum, indicating that control has been lost and that the filtering action of the regulator likewise has disappeared. With the regulator working, it is extremely difficult to detect any hum. The additional filtering makes it possible to dispense with the second filter section ordinarily required, so that a voltage-regulated supply actually costs very little more than an unregulated supply having equivalent filtering.

All in all, a well-regulated power supply should find many uses in the station.

A.R.R.L. Copying Bee Results

THREE operators tied for first place in the third A.R.R.L. Copying Bee (December, 1936): L. R. Clements, W2HHG, J. Y. Bowman, W5FCQ, and H. G. Martin, W6GVT, each made a rating of 98%, copying correctly forty-nine of the fifty groups transmitted. They have



JESS Y. BOWMAN, W5FCQ, AND THE LOCATION WHERE HE MADE HIS WINNING COPY

been awarded engraved medallions in recognition of their proficiency. Congratulations, OM's!

There were 150 amateurs competing in the "Bee." Stations W1INF, W2AYN, W9BAZ, W9UZ, W6AM and W6CIS, using frequencies in the 3.5- and 7-Mc. bands, transmitted at about 25 words per minute fifty words and jumbled groups totalling 367 characters (letters and numerals). Each word or group copied correctly counted 2%. No operator made 100%, due to the difficult nature of the texts. Different texts were sent from the east coast, central and west coast stations. It was necessary to submit a copy of one station only, although many operators copied more than one station and submitted best copy.

Corrected copies have been returned to all contestants together with copies of the texts transmitted by the various stations so that each operator may see where he slipped up. It was an unusually stiff test and no operator need feel too badly about his rating.

It was a strictly amateur contest. Each contestant had to certify that he had not been employed as a commercial or government radio, Morse or cable operator within the year preceding the Copying Bee. The following exceptions, however, were eligible: (a) Holders of commercial licenses without experience under same. (b) Such holders (phone licensees or technical attendants) whose duties had not been telegraph operating within one year.

Final Ratings

W9BAZ was logged by 88 participants, W1INF by 62, W2AYN by 39, W9UZ by 36, W6CIS by 29 and W6AM by 21. 51.6% of all

contestants made best copy from W9BAZ, 17% from W1INF, 12.4% from W6CIS, 10.4% from W9UZ, 6% from W6AM and 2.6% from W2AYN.

Participating operators are here listed according to accuracy of copy, ratings of 50% or higher being indicated:

98%: W2HHG W5FCQ W6GVT 94%: W8AEH W9WRK 92%: W2BJY W3EEN W3GKN W5BMI W5ENI W9ESA 90%: W1IGB W2DUP W7CZX W8BEN W9KJY W9RLB 88%: W1GBY W1IOE W6DVD W6FZL W8BKM W8CDK W8PSM J. R. Thorburn 86%: W3CMV W2JKY/W3FGS W4DYZ W5BJL W9VKF 84%: W2JEQ W3EZ W4AKJ W5CPT 82%: W3QM W4AGI W6CSC W6EYR W7BXQ W9HCC VE5OK 80%: W3AMR W6OGJ W8KUN 78%: W1CHF W1GUA W2CCZ W2GKH W4DVO W7ELF 76%: W3AKB W4BDT W6MTP 74%: W2GGW W4CRZ W7EOH W9CWR W9RQR W9SGP 72%: W5FSJ W9ANV W9DOP VE3SS 70%: W1ABG W1IYC W3EHW W4CEI W9DOU/W8PNG 68%: W2IVR W3GBK W6IDW W8EKG W8JTT W8PGI W9LQU 66%: W2OQ W3ADE W3BWT W4BVD W6NGA W8CVS (L. W. Krute) 64%: W6LRN W9KUI VE5LA 62%: W5DQD 60%: W1BEF W1HW W2AJL W6LUO W9DI 58%: W1JID W3FXV W5EJT



H. G. MARTIN, W6GVT, ONE OF THE THREE COPYING BEE WINNERS

W6NEN 56%: W8GUN 54%: W9OTR W9UEG VE5II 52%: W2GES W3GHW 50%: W2IVU W2HYC W2ELK Below 50%, in order: W3FBM-W9AHA-W9MFH-W9PTU-W3EAP W4DOQ-W6MUR-W7EBQ-W8ORM W3COK W7FZB-W8AFE W2BJX-W2JKT-W2JRS-W8EU-W9OVD W2LH W4BQK-W7ESM-W8ISK-W9MWU-VE2FD W8DCE-W8NWZ W4EFM-W8QGD W2CEN W7CWN-W8CVS (S. W. Krute)-W9UFT W1JIY-VE4CQ W4DOV-W5FCJ-W9SDC-VE1EX W2GTA-W2HGO-W3DXK-W9KIK W9SSL W6OJW-W8KHY W7FZR W2HOI-W3BGD.

—E. L. B. & T. W. Y.

What the League Is Doing

League Activities, Washington Notes, Board Actions—For Your Information

Pan-American Traffic

At the request of the A.R.R.L. Board of Directors, the Federal Communications Commission concurring, the Department of State is proposing to the American regional conference to be held in Habana in November the question of a uniform arrangement between all of the American countries, permitting amateurs to handle third-party messages of a type that would not normally go by paid commercial service. As most amateurs know, we already have such arrangements between this country and Canada, Chile and Peru; and to us there seems a good chance that there can now be general agreement on a uniform practice between all of the American countries. It would, of course, aid materially in advancing the common destiny of the peoples of the Americas.

F.C.C. Notes

So many of the important administrative officials of the F.C.C. have been absent from the country this summer attending international conferences that amateur affairs in the Telegraph Division have moved with great slowness. It was not until June 29th that the Commission took up the Board's request for a change in the 'phone allocations in the 23-30-Mc. band, and then just to put it on record until July 31st, to afford opportunity for any objections to be filed with the Commission. All of the other League matters pending before the Commission have been similarly stalemated during the early summer, with no possibility of action during the absence of the people who have to pass upon these matters. However, with a lull now between conferences, we hope that we can soon report some action.

B.C.L. QRM

At its annual meeting the Board of Directors expressed concern over the extent to which cheap midget superheterodyne receivers experienced interference from amateur stations, through no fault of the latter but because of insufficient design features of the former. Resolutions were transmitted to the Radio Manufacturers Association concerning possible improvement in the design of these receivers to preclude this pickup. The R.M.A. now advise us that the matter has been considered by their Board of Directors and the question referred to their engineering division with a request to report back, as soon as possible, the remedial measures possible. They state that "it is hoped that effective steps will be taken which will reduce and possibly entirely remove the cause of com-

plaint from amateur operators of experimental stations, through future improvement in the design of commercial sets of the midget type."

Class-A Code Exams

Members write in to ask us whether a Class-C amateur, going up for the Class-A exam, needs to take another code test. There seems to be considerable diversity of practice in the field offices of the F.C.C. Most of the time a Class-C man is not given another code examination, but we know of quite a few cases within the past year when it did occur. We even have heard of one Class-C man who went up for Class A and was obliged to take two code examinations the same day, one for Class B and one for Class A. Hi! Anyway, we asked the F.C.C. about it and here is the dope:

An applicant with a valid Class-B license does not need to take another code examination. If his Class-B license has expired, he must take the code test. And if he has only a Class-C license, of course he must take the code test.

Operator Rules

Extensive amendments to the Communications Act of 1934 were adopted on May 20th to make effective the provisions of the International Convention for the Safety of Life at Sea. A new section has been at work in the F.C.C. for many months drafting ship safety rules, and the whole question of marine radio has been overhauled. The great bulk of the material is of no concern to amateur radio but we notice a few items of amateur interest:

Amongst the offenses for which the Commission may suspend an operator license are now definitely listed the intentional transmission of "false or deceptive signals or communications, or a call signal or letter which has not been assigned by proper authority to the station he is operating."

It is also stipulated that F.C.C. may suspend the license of an operator who "has obtained or attempted to obtain, or has assisted another to obtain or attempt to obtain, an operator's license by fraudulent means." Amongst other things, this is a warning to hams who give code examinations and monitor the written examinations for Class-C applicants!

Amongst extensive alterations in the rules governing the necessary operators on shipboard is one which now requires a marine radio officer to have

(Continued on page 7E)

A Unit-Style Portable Station

Genemotor-Powered 'Phone-C.W. Assembly with Superhet Receiver and 35-Watt 6L6 Transmitter

By Clinton B. DeSoto, W1CBD and Byron Goodman, W1JPE*

PORTABLE radio equipment ordinarily finds application in three general uses: on field days, vacation trips, and in emergencies. Ideally, each of these uses requires equipment of special qualifications; yet the average amateur is lucky if he can assemble just one complete outfit of portable gear and keep it in operating condition.

With the approach of the 1937 Field Day, our thoughts naturally turned to the assembly of suitable equipment for the occasion. Last year W1JPE put a 6L6 and some miscellaneous components in a wooden box, convinced himself that he had a portable, and went out and had a lot of fun in the 1936 Field Day. Even the most casual observer couldn't take a portable into the field, operate a number of hours, and not return with a few ideas. When his glib tongue convinced other members of the secretarial staff that they had missed themselves a time by not taking part, and

would be created on a broader perspective than just this one field day. All-around utility, for all kinds of trips and other applications, and in particular for emergency work, was made the objective. The equipment to be described represents an attempt to reduce a certain amount of practical experience with various portable applications to literal apparatus forms.

Fundamentally, the equipment consists of four units: power supply; transmitter, modulator and receiver. The individual unit style of construction was adopted because it lends desirable versatility to the layout as well as ease in transportation. Experience a couple of years ago in manhandling a heavy portable built into a suitcase on a 7500-mile swing around the country emphasized the latter point.

THE POWER SUPPLY

The limiting factor in the design of any portable equipment is, of course, the power supply. It is possible to build a portable a.c.-operated rig that need only be connected to the nearest 115-volt line, but we wanted something that would be independent of commercial power sources—both to add a Field Day multiplier and for possible emergency needs. Any portable equipment suitable for emergency work should be capable of working from a 6-volt battery as the primary supply, since it is always possible to secure such a battery somewhere, even if it has to be commandeered from an automobile.

It was finally decided to build the station around one of the excellent combination Genemotors, designed primarily for two-way police systems, that give 250 volts at 50 ma. for the receiver (and in this case the modulator, when 'phone is used) and 350 volts at 100 ma. for the transmitter. The Genemotor is mounted on a solid wooden frame, underneath which are the various filter condensers and chokes. A complete switchboard, enabling flexible control of all elements of the system, and sockets to take the

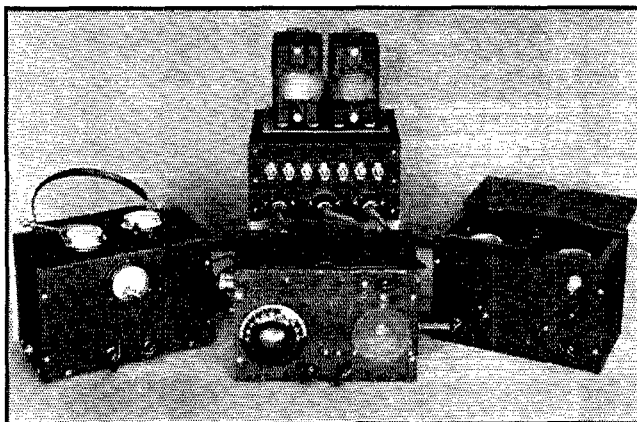

THE COMPLETE PORTABLE STATION—ADD A 6-VOLT BATTERY AND IT'S READY TO GO

In the rear is the dual Genemotor assembly, with switchboard and cable sockets. In the foreground, left to right, are the Class-B modulator, 4-tube superhet receiver, and 35-watt input crystal-controlled transmitter. All are built in 5 by 6 by 9-inch metal cabinets.

enlisted them in the 1937 venture, these ideas were naturally incorporated in the new layout.

At the same time it was decided that, in view of the varied qualifications and requirements of all-around portable equipment, the complete design

* Asst. Secretaries, A.R.R.L.

cable plugs are mounted on a front panel. This makes setting up the equipment a speedy and easy matter; while operating, once the switch order is memorized, is flexible and straightforward.

Two words of warning in connection with the Genemotor supply: First; elimination of radiation from the various power supply leads is no simple task, especially when a sensitive superheterodyne receiver is used, and it is strongly recommended that the special filter unit supplied by the manufacturer be used. For those who get a kick out of trouble, filter circuits and constants are shown in the power supply diagram. Second; be sure to use short, heavy battery leads. The ordinary cable used for this purpose on automobile receivers is far from adequate, showing a tremendous IR drop under the heavy total current conditions (17 amperes or more). Regular car-battery cable and lugs are advised.

THE TRANSMITTER

Last year a single 6L6 was used in the portable rig. Since that time Jim Lamb found out a few more things about the tube in the Tri-tet circuit,¹ and a few ideas of our own had been added. In the first place, while tuning to two bands with a single condenser had been satisfactory in the

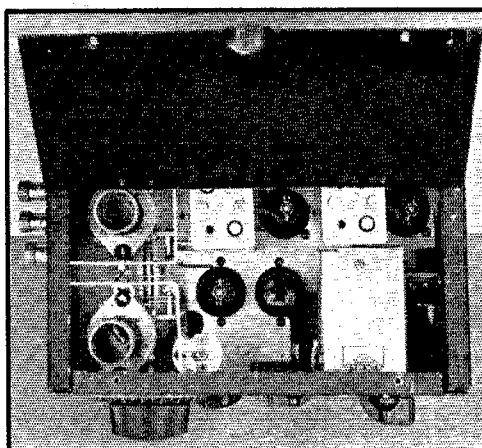

LOOKING INTO THE RECEIVER, TOP VIEW

The antenna coil plugs in at rear, oscillator at front. The r.f. trimmer condenser is controlled by a knob at the left, while the screw-driver adjusted oscillator trimmer is visible in front. The tube line-up; 6A8 mixer at left, 6F6 power tube, above it the 6K7 regenerative i.f. tube, and at upper right the 6A8 second detector.

Other experiments with 6L6's had shown that unless a certain amount of capacity were used, the

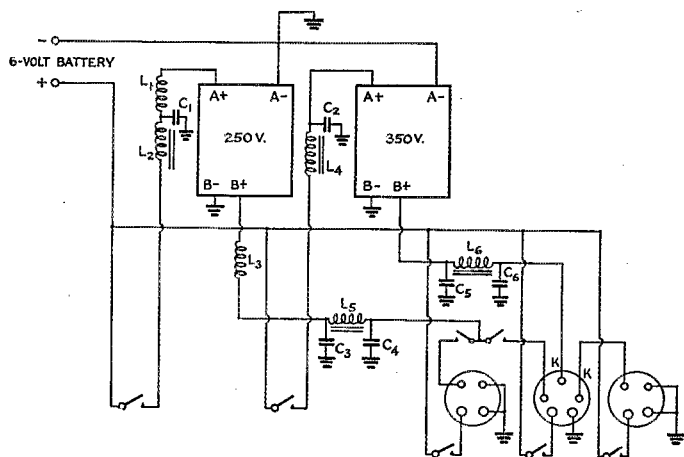

FIG. 1—THE POWER SUPPLY CONNECTIONS

- L_1 —R.f. choke (20 turns No. 12 wire).
- L_2 , L_4 —6-henry "A" choke.
- L_3 —R.f. choke (300 turns).
- L_5 —8-henry 50-ma. plate choke.
- L_6 —10-henry 100-ma. plate choke.
- C_1 , C_2 —0.5- μ fd. 200-v. paper.
- C_3 , C_6 —0.1- μ fd. 600-v paper.
- C_4 , C_5 , C_6 —8- μ fd. 500-volt electrolytic.

Bottom views of sockets are shown. Left to right, they take receiver, modulator (or key or tuning milliammeter across "K-K" terminals) and transmitter plugs. Switches turn on either or both Genemotors, connect heaters in each or all of the three units, and change 250-volt supply from receiver to modulator.

other rig, we hardly thought we could get away with it in this one, which was going to use two 6L6's in parallel, because the doubled plate current would require a larger tank condenser.

¹ Lamb, "Survey of Pentode and Beam Tube Crystal Oscillators," *QST*, page 31, April, 1937.

condenser settings for minimum plate current and maximum output were widely different. So plug-in coils for all bands were used, instead of trying to hit two bands with one condenser. That may be satisfactory for one tube, but it is inadvisable for two. It is nice to be able to shift frequency quickly, without diving into the set to change crystals, so a crystal switch was included which permits selection of one of two crystals, a great help when the little peep is smothered by Q.R.M. There seemed to be no great need for an external control of the capacity in the cathode circuit, so the cathode tuning condenser was made an integral part of the cathode coil.

The transmitter is built on a piece of $\frac{1}{16}$ -inch aluminum which is fastened to two pieces of $\frac{1}{4}$ -inch brass rod bolted to the front and back of the metal housing can. This allows the transmitter unit to be taken out and serviced if necessary. All of the construction is straightforward except possibly the socket for the crystals, which was made from a piece of bakelite strip with contacts taken from a broken socket. The

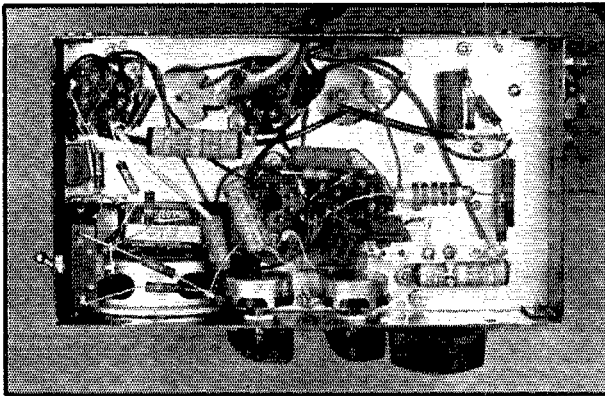

LOOKING INTO THE RECEIVER BOTTOM VIEW

Leads cannot be other than short in so compact an assembly. At the rear center can be seen the tickler for the regenerative i. f. circuit, its leads being spaghetti-encased and firmly fastened. An insulantite bar insulates and rigidly holds the r. f. oscillator grid and plate leads.

contacts were drilled out and riveted to the bakelite strip. This was done simply to conserve space, and the strip could of course be replaced by the conventional wafer sockets in an installation where space was not at a premium. The tuning condenser and antenna coupling condenser are mounted on the Cardwell bracket furnished with them, thus serving as support and insulating the condenser from the metal chassis at the same time.

Keying is done by plugging across the modulator socket terminals on the power supply, marked "K-K" (see diagram). The transmitter is tuned like any other Tri-tet oscillator. An end-fed antenna is coupled on to the antenna post, and the antenna coupling condenser run in until the neon bulb on the antenna post looks right and the keying sounds decent in the receiver. Incidentally, this type of capacity coupling to an antenna is

COIL TABLE

	L_1	L_2	L_3	L_4
3.5 Mc.	6 turns *4	44 turns †3, 1"	28 turns *3	36 turns *5
7 Mc.	4 turns *4	22 turns †2, 1"	16 turns *2	20 turns *5
14 Mc.	3 turns *4	11 turns †1, 1"	8 turns †1, 1/2"	12 turns *5

* Closewound.

† Spaced to length shown.

¹ No. 18 enamel wire.

² No. 22 enamel wire.

³ No. 26 enamel wire.

⁴ No. 28 d.c.c. wire.

⁵ No. 30 enamel wire.

L_1 is wound self-supporting on 3/4 inch diameter in each instance, doped for rigidity, and then mounted inside the coil form at the bottom.

In series with the ground return of each oscillator coil is wired a fixed mica condenser, as shown in the circuit diagram, mounted inside the coil form. For 3.5 Mc., this condenser has a value of 500 $\mu\mu\text{fd.}$, for 7 Mc. 1000 $\mu\mu\text{fd.}$, and for 14 Mc. 2000 $\mu\mu\text{fd.}$ To facilitate wiring-in this condenser, L_3 is wound on the bottom of the forms.

All coils are wound in the same direction. Spacing between L_3 and L_4 should be about 1/8-inch. Grid and plate leads come off at the coil ends, ground returns in the center.

All coils are wound on National XR-1 1-inch diameter forms, and are heavily doped to withstand rough handling.

quite legal, a point that was not brought out last year and which resulted in several inquiries.

THE RECEIVER

The problem of designing a portable receiver these days has, it seems, reached a state where the only question is to decide what to leave out. Recent results from progress in research and manufacturing techniques have provided such a profusion of circuits and components that almost any desired result can be achieved. All that is left is to pick those that will accomplish that result in the smallest space and with the least complexity.

The receiver constructed for use in this portable assembly is a four-tube superheterodyne. It represents a mid-point between the home-station super with a standard tube complement and the ancient and honorable superhet circuit using a regenerative converter and detector with no i. f. amplification. The latter is, as a matter of fact, hardly a super at all, but a variation of the autodyne in which the regenerative or oscillating

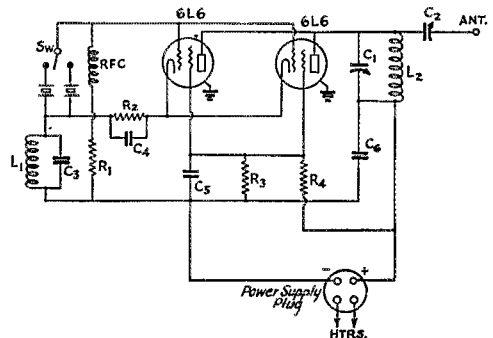

FIG. 2—THE TRANSMITTER DIAGRAM

C_1 —140- $\mu\mu\text{fd.}$ midget variable (Cardwell ZU-140-AS).

C_2 —100- $\mu\mu\text{fd.}$ midget variable (Cardwell ZU-100-AS).

C_3 —100- $\mu\mu\text{fd.}$ air padding condenser (Hammarlund APC-100) or L_1 can be trimmed and a 75- $\mu\mu\text{fd.}$ fixed mica condenser used for C_3 . Mounted inside of L_1 .

C_4 —0.001 postage-stamp mica condenser (Aerovox).

C_5, C_6 —0.002 postage-stamp mica condenser (Aerovox).

R_1 —50,000-ohm 1-watt resistor (IRC).

R_2 —200-ohm, 10-watt wire-wound resistor (Ohmite).

R_3 —50,000-ohm, 2-watt resistor (Centralab).

R_4 —5000-ohm, 10-watt wire-wound resistor (Ohmite).

L_1 —12 turns spaced to occupy 1 1/2 inches total length. C_3 mounted inside form.

L_2 —3.5-Mc. output 23 turns spaced to occupy 1 1/2 inches total length.

7-Mc. output. 12 turns spaced to occupy 1 1/4 inches.

All coils wound of No. 18 enameled on Hammarlund SWF-4 coil forms.

detector is operated under conditions of constant stability, improving the performance over a number of bands and especially on the higher frequencies. In this receiver a much higher order of selectivity can be achieved, especially on c.w., than with such an arrangement.

The four tubes are, in order: 6A8 mixer; 6K7 regenerative i.f.; 6A8 second detector and b.f.o., and 6F6 output. For descriptive purposes, it will probably be simpler to work from the audio end backwards.

The 6F6 is operated with high bias, reducing the maximum output but saving on plate current. It drives the tiny 3½-inch Premier speaker at adequate volume for listeners grouped around the operating position, although ordinary "room level" is not attained without blasting. As a matter of fact, in most applications the speaker is dispensed with, headphones being used in preference. The speaker is incorporated in the present design simply to meet individual preferences where they exist. For applications in which more space is available a full-size speaker with a proper input transformer and standard audio stage are recommended.

The use of a pentagrid tube for combined second detector and b.f.o. is not common in ham practice, although it has been done.² In this arrangement it proves very satisfactory indeed.

² Allen, "New Pentagrid Tubes in the Amateur-Band Superhet," *QST*, page 12, August, 1933.

The only complication comes in lowered gain when the b.f.o. is turned off, for modulated reception. This might be attributed to lowered

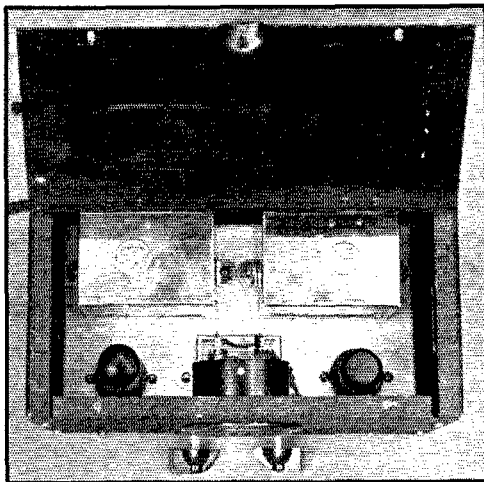

THE MODULATOR UNIT

The microphone transformer is under the meter, input transformer at right, output at left. The 6N7 delivers 8 to 10 watts of audio with a carbon mike.

conductance due to the removal of potential from the anode grid, although the application of

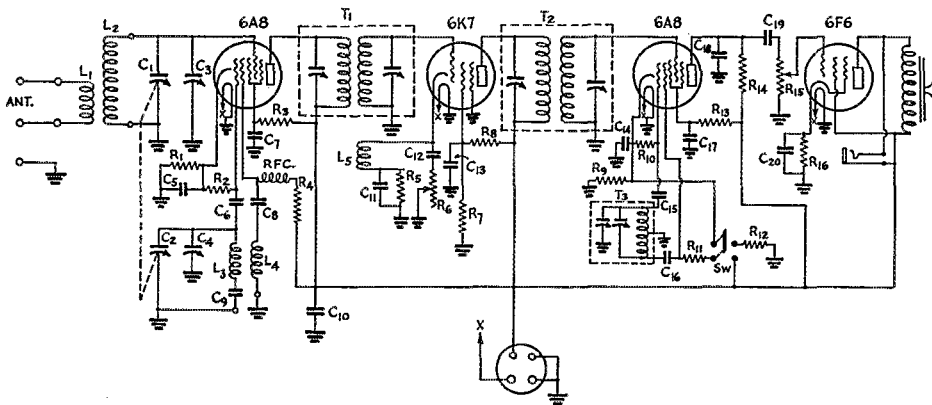

FIG. 3—THE RECEIVER CIRCUIT

- L₁, L₂, L₃, L₄—See coil table.
- L₅—See text.
- C₁, C₂—Dual tuning condenser, 25- μ fd. per section (Cardwell ER-25-AD).
- C₃—50- μ fd. antenna trimmer condenser (Hammarlund HF-50).
- C₄—50- μ fd. oscillator trimmer condenser (Hammarlund APC-50).
- C₅, C₇, C₁₁, C₁₂, C₁₃—0.01- μ fd. 400-volt paper.
- C₆, C₁₅—100- μ fd. midget mica.
- C₈, C₁₈—0.001- μ fd. midget mica.
- C₉—See coil table.
- C₁₀—0.05- μ fd. 400-volt paper.
- C₁₄, C₂₀—Dual 5- μ fd. 35-volt midget electrolytic.
- C₁₇—0.05- μ fd. 200-volt paper.
- C₁₈—250- μ fd. midget mica.
- C₁₉—0.005- μ fd. 400-volt paper.

- R₁, R₅—300-ohm, ½-watt carbon.
- R₂, R₃, R₁₀—50,000-ohm, ½-watt carbon.
- R₄, R₇—20,000-ohm, ½-watt carbon.
- R₆—1000-ohm potentiometer (IRC).
- R₈—20,000-ohm 1-watt carbon.
- R₉—15,000-ohm ½-watt carbon.
- R₁₁—100,000-ohm ½-watt carbon.
- R₁₂—500-ohm ½-watt carbon.
- R₁₃—3-megohm ½-watt carbon.
- R₁₄—0.5-megohm ½-watt carbon.
- R₁₅—1-megohm potentiometer (IRC).
- R₁₆—1000-ohm ½-watt carbon.

- T₁, T₂—1600-kc. i.f. transformers (Sickles No. 6614).
- T₃—800-kc. b.f.o. transformer (Sickles No. 55251).
- SW—B.f.o. on-off switch, d.p.s.t.

static (non-oscillating) potential did not noticeably improve performance. In any event this complication is not serious, for the reduction in gain is less than 2 to 1 and is hardly noticeable in operation.

A glance at the circuit diagram will show that

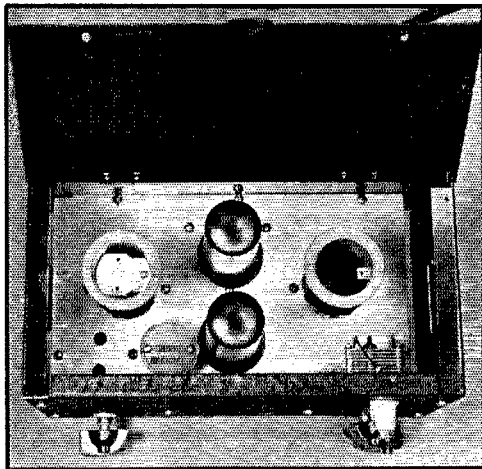

PLAN VIEW OF THE TRANSMITTER UNIT

The cathode coil on the left has the cathode tuning condenser built in as an integral part. One crystal has been removed from its socket to show the socket construction. The plate tuning condenser is mounted below the sub-base; the antenna coupling condenser is mounted above and is insulated from base and cabinet. The end-fed antenna is connected to the feed-through insulator on the panel.

the switch which disconnects the anode grid voltage also, by removing a shunt, increases the value of the bias resistor in the 6A8 cathode circuit. This is done to compensate for the lowered cathode current.

The b.f.o. coil assembly is a Sickles 800-kc. unit with two modifications. First, the $4\frac{1}{2}$ -inch can in which the assembly is supplied is cut down to a length of 3 inches to enable mounting horizontally above the speaker, with the tuning condenser shaft projecting through the front panel. Second, the rotor of this small parallel tuning condenser is disconnected from the plate end of the coil (the grounded end in the conventional e.c. oscillator) and is instead connected to the cathode tap, which is the grounded terminal in this circuit. This is done to eliminate body capacity effects.

No, that 800 kc. at the beginning of the last paragraph isn't a typographical error. The i.f. used in this receiver is 1600 kc., and the second harmonic of the b.f.o. is used, to prevent pulling. The high i.f. was chosen in order to eliminate the necessity for pre-selection—objectionable both from the standpoint of

space requirements and the necessity for an additional set of plug-in coils.

Full-size air-tuned i.f. transformers are used; here is one place where skimping to save an extra half-inch of space or dollar of cost is not worthwhile. While not equal to good 450-kc. i.f.t.'s, these 1600-kc. iron-core units have adequate gain and selectivity, and what they lack is made up by the regenerative circuit.

The use of controllable regeneration in i.f. amplifiers is an asset only too rarely utilized in amateur receivers not equipped with piezo-electric filters. This condition is unfortunate. Such receivers as have been described³ employing regeneration for added selectivity and gain have been individually highly successful. The principle as applied to this receiver works out equally well on the bench and in preliminary trials; how it will stand the rigors of outdoor work is, of course, something still to be seen.

Construction of the regenerative circuit is relatively simple. The first requirement is to disassemble one of the standard Sickles 1600-kc. i.f.t.'s. The grid and plate leads are then reversed, as are the B+ and ground returns; this makes the bottom coil the grid coil, simplifying mounting and adjustment of the tickler. The tickler itself consists of 10 turns of No. 28 d.c.c. wound over a $\frac{1}{4}$ -inch form and doped to make a self-supporting coil. It is slipped over the protruding end of the dowel in the i.f. assembly, which projects below the terminal lug plate.

In lining up the i.f., the regeneration control is set so that all resistance in the cathode circuit is shorted out. Alignment is then carried on as usual, with the test oscillator connected first to the 6K7 grid and then to the 6A8 mixer grid. The output meter can conveniently be connected to the headphone jack.

To adjust regeneration the regeneration control

³ Lamb, "Cutting the Cost of Single-Signal Reception," *QST*, page 8, April, 1933.

Woodward, "Regenerative S.S. Receiver Brought Up to Date," *QST*, page 64, May, 1934.

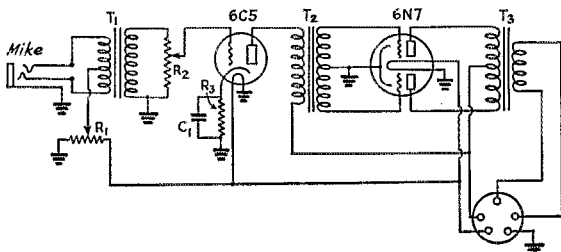

FIG. 4—THE MODULATOR SECTION

- | | |
|--|---|
| T ₁ —Double-button microphone input transformer (UTC CS-104). | C ₁ —5-ufd. 25-volt electrolytic. |
| T ₂ —Class-B input transformer (UTC CS-29). | R ₁ —500-ohm potentiometer (IRC). |
| T ₃ —Class-B output transformer (UTC CS-33). | R ₂ —0.5-megohm potentiometer (IRC). |
| | R ₃ —1000-ohm, $\frac{1}{2}$ -watt carbon. |

is turned wide open, whereupon the tickler is moved up and down until the point is reached where the circuit just edges into oscillation. At this point the tickler is firmly fastened with Duco cement or some similar fastener. The regeneration control will then provide selectivity ranging from quite broad to single-signal, with the characteristic sharp ringing or "pinging" characteristic at the latter end of the scale.

The mixer utilizes a pentagrid converter with self-contained oscillator. Such an arrangement is not ordinarily regarded with favor in amateur superhets, but in the present case, with the high i.f. and good circuit components, its stability and general performance are reasonably satisfactory. Certainly it is as good or better than the

average all-wave broadcast receiver, and the latter in turn are usually better than the average portable job, so the comparison seems favorable.

A self-aligning-tracking system is employed that works out quite effectively. After many headaches trying to adjust variable series pads in oscillator circuits in the past, it was resolved to avoid that bother in this set. Standard values of fixed mica condensers were selected for the series pads, therefore, and the coils calculated to fit. The use of mica condensers in an oscillator circuit is not ordinarily the wisest procedure, but in this case the capacity values are many times that of the tuning condenser and percentage variations with humidity or thermal changes are small.

In order to eliminate the necessity for trimmers on each coil the usual procedure was again reversed and a single fixed trimmer was used in the oscillator circuit. This trimmer is adjusted once, and each coil wound to fit that setting. Naturally the minimum capacities in the r.f. circuit for different bands will change; this is taken care of by the inclusion of an externally-controlled variable trimmer in the mixer grid circuit. Tracking on each band is compensated for by the simple procedure of adjusting this trimmer knob for maximum signal strength.

The antenna primaries are much smaller than usual in sets of this type. The reason for this is to improve the image rejection ratio; it was found

that doubling the size of the antenna coil on 80 meters (with 400-ohm input) improved the overall gain only 25 per cent but boosted the strength of the image by 1400 per cent. With the specified values the image ratio is 40 db or more on all bands.

The construction of the set is straightforward, but it must be approached in a logical manner.

After all, there are a lot of parts to be jammed into a space 5 x 6 x 9 inches! The photographs adequately show the general layout and placement of parts; a few constructional hints may be helpful.

The sub-base, made of $\frac{1}{16}$ -inch aluminum, is mounted $1\frac{1}{4}$ inches from the bottom—just room enough to accommodate the variable resistors. It is fastened to the

front and back walls by two pairs of small angle brackets, into which 6/32 screws are threaded. Before the final assembly a "dress rehearsal" in which all parts are mounted, all holes drilled, and all fitting accomplished, is held. The parts on the sub-base and front panel are first assembled and the two united; then the rear wall is added and the plug-in coil shield assembly installed. Following this the end walls with their supplementary components can readily be added. While serviceability is not, inevitably, a paramount feature of so constricted a design, almost every part except the b.f.o. assembly can be removed or replaced with surprising ease.

THE MODULATOR

Basically, this portable gear was designed for c.w. operation, and both transmitter and receiver perform to their fullest capacity only when handling code. This is as it should be, for the limited capabilities of low-power portable equipment must necessarily be permitted a maximum of efficiency, and this implies c.w. operation.

However, 'phone can often be employed to advantage even in portable work when conditions are suitable. It is often especially useful in connection with emergency work, and one of the prime objects of this equipment was its adaptability to emergency needs. Therefore a modulating unit

(Continued on page 82)

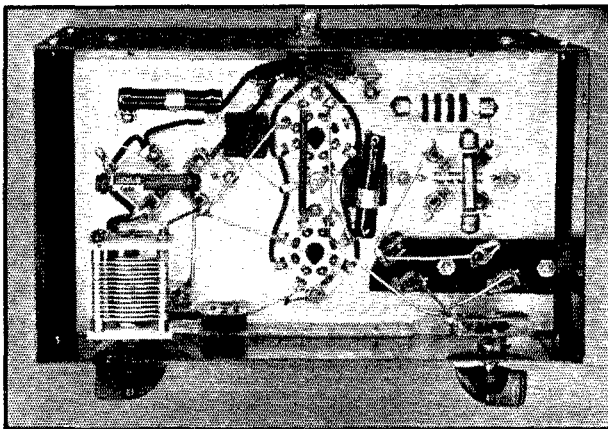

THE UNDER SIDE OF THE TRANSMITTER SHOWS THE SIMPLE AND STRAIGHTFORWARD CONSTRUCTION

The socket for the two crystals is made from contacts from a broken socket riveted to a bakelite strip. Free terminals on tube sockets are used to mount resistors and chokes, eliminating the need for several tie-strips.

● ARMY-AMATEUR RADIO SYSTEM ACTIVITIES ●

THE Board of Directors of the A.R.R.L. at their last meeting offered the use of one page of each issue of *QST* to the Army-Amateur Radio System. This offer is greatly appreciated and is accepted by the Chief Signal Officer. It is hoped that this page will be of interest to all readers of *QST*, as well as to members of the A.A.R.S.

For the information of those who may not be well acquainted with the A.A.R.S., the following brief description will explain:

The Army-Amateur Radio System was first organized in 1925 with the assistance of the American Radio Relay League. It is an organization of radio amateurs voluntarily affiliated with the Signal Corps of the U. S. Army. Its primary method of training is the handling of messages in accordance with Army procedure. The system is operated under the direction of the Chief Signal Officer in Washington, who appoints a Liaison Officer, A.A.R.S., to handle amateur matters. Control is divided into nine areas within the continental limits of the United States under the Signal Officer of each corps area.

The A.A.R.S. is organized to assist the Red Cross and military commanders in times of disaster or national emergency by providing additional channels of communication throughout the United States to augment or replace land lines that might be damaged or destroyed.

Radio nets are organized to operate on spot frequencies and consist of the Army Net, Corps Area Nets, State and District Nets. The net control station of the Army Net is WLM/W3CXL, located in Washington, D. C. This station maintains schedules with corps-area net control stations and also with Panama and Hawaii. Each corps area has a net control station which also works with various state net control stations within the corps area. The Army Net and Corps Area Nets normally operate on special frequencies using call letters assigned by the Chief Signal Officer. Other nets operate in the amateur bands.

Operation is normally from September 1st to May 31st each year. However, nets continue to operate with reduced numbers during the summer months, though operation is not required to maintain active status.

— —

A ZCB (QSO) contest was held from 6 p.m. E.S.T. May 30th to 12:00 midnight E.S.T. May 31st. Each contact counted one point and additional credit of ten points was allowed for contact with all nine corps areas. Complete reports have not reached this office as yet but some members have reported working all corps areas on eighty meters. The largest score to date is 131 points. Complete results will be given later.

A questionnaire was recently sent all A.A.R.S. members. From these reports we observed several estimates of copying speed of thirty to thirty-five w.p.m. in five-letter code groups. On Monday, June 7th, WLM broadcast for five minutes five-letter code groups at 25 w.p.m. and requested those listening to copy with a pencil.

— —

PDC, the monthly bulletin of the Chief Signal Officer which has formerly been published on the first of each month will hereafter be published on the 15th of each month. The monthly report from Corps Area Signals formerly due on the 22d of each month will hereafter be due on or before the last day of each month. All members should, however, get their traffic reports in as soon after the 15th of each month as possible.



DIXIE JONES' OWL JUICE

THIS column of juice wishes to assure Mr. Garcia, of CM2AO, whose letter follows, that he ain't the only one that can't make no sense outa the hifalutin' langwidge in *QST*. The trouble is the writers are so doggone edicated that the main idea gits sidetracked behind a coupla verbs or sumpn and if ya ain't plenty good ya miss it. This "Message From Garcia" points a moral even as did the "Message To Garcia" of forty years ago.

"Habana, April 17, 1937

"Dear Mr. Dixie:

"You and *QST* has gave me big surprise. For the long time since I have trying to learn the English. I had the teachers and the teach-eresess but was not never available to read the tongue. Then one day I was looking in *QST* the diagrams I could descifer but the words were more worsor I could not descifer until all at the once I consciously understood what I was looking into over the page. It was your juice even the rhinnerhosses and other byrds. I am sorry about the picture and you hanging into the mike as I keep always hanging myself by the key forever. But I liked it all as I could get the meanness of it. Please do more so es pse where can one get diccionary of yours and subscripcion to Squinch Owl? 73 excuse dx adios QRU, AK, SK.

"Yours truly,

"S. E. GARCIA, CM2AO,
Calle 13, No. 97 Vedado, Habana, Cuba."
—W4IR of the "Dixie Squinch Owl"

● NAVAL COMMUNICATION RESERVE NOTES ●

Details of the Emergency Communication Plan

By Lieut.-Commander Wm. Justice Lee, C-V(S), U. S. N. R.

A NUMBER of years ago, seven to be exact, the Navy worked out a plan for emergency communication for its Naval Reserve stations in connection with Red Cross relief.

This plan was based upon the fact that in almost every city of the United States there is a chapter of the Red Cross and likewise in a great many cities in the United States there are one or more members of the Naval Communication Reserve who own and operate their own amateur radio stations. After a number of conferences with the Red Cross it was decided that a member of the Naval Communication Reserve should be appointed on each local chapter Subcommittee of Transportation & Communication and that this Naval Reservist would act as the liaison representative of the Communication Reserve with the Red Cross in that particular locality.

The entire plan is based upon the knowledge acquired during past emergencies or disasters when normal channels of communication have failed and under these conditions the Communication Reserve-amateur radio stations stepped to the fore and established communication with the outside world. The plan is divided into two major classifications, (a) predictable disasters, (b) unpredictable disasters. Under the former classification come general floods and hurricanes and under the second classification come fire, earthquake, tornado, sleet storm, bursting dam, landslide, volcanic eruption, cloudburst, explosion and possibly some others.

In case of any disaster the local Naval Reservist at the scene of the disaster will attempt to forward his report to his Commandant at his Naval District Headquarters, routing the dispatch according to methods which will be described later on, and bearing in mind that when a real emergency occurs which involves the possibility of injury and loss of life, every means may be considered allowable when attempting to establish communication with the outside world.

The American Red Cross maintains area headquarters in three cities. When a disaster occurs the Naval Reservist originating the report will send his report to his District Commandant. The Commandant will take such action as he deems necessary and will immediately file a priority dispatch by Navy radio or commercial landline to the area office of the American Red Cross which has jurisdiction over the state in

which the disaster has occurred. These offices and the states which are included in their area are shown below:

- (a) *American Red Cross, National Headquarters, 17th and D Streets, N. W., Washington, D. C.*, for disasters in the following states: Maine, New Hampshire, Vermont, Massachusetts, Rhode Island, Connecticut, New York, Pennsylvania, New Jersey, Delaware, Maryland, Virginia, District of Columbia, West Virginia, Indiana, Ohio, Kentucky, North Carolina, South Carolina, Georgia, Florida, Tennessee, Mississippi, Alabama and Louisiana.
- (b) *American Red Cross, Midwestern Branch Office, 1709 Washington Avenue, St. Louis, Missouri*, for disasters in the following states: Wisconsin, Illinois, Minnesota, Iowa, Missouri, Arkansas, North Dakota, South Dakota, Nebraska, Kansas, Oklahoma, Texas, Montana, Wyoming, Colorado, New Mexico and Michigan.
- (c) *American Red Cross, Pacific Branch Office, Civic Auditorium, San Francisco, California*, for disasters in the following states: Idaho, Utah, Arizona, Nevada, Washington, Oregon and California.

In order to insure as far as possible that a successful contact may be made, four different methods of communication have been worked out known as Methods (A), (B), (C) and (D). Assuming that the first word of a disaster is originated at a Reserve-amateur station, the station of origin has the opportunity of sending it over any one of the following channels:

METHOD (A)	
<i>Channel 1</i>	<i>Channel 2</i>
Originator	Navy shore station
Section control station	Navy Department
Master or alternate control station	Red Cross Area Headquarters
Naval District shore station	
Navy Department	
Red Cross Area Headquarters	
METHOD (B)	
<i>Channel 1</i>	<i>Channel 2</i>
Any amateur radio station	Commercial high-frequency radio station
Commercial wire or h.f.	Naval radio station
Commercial radio station	Red Cross Area Headquarters
Naval radio station	
Navy Department	
Red Cross Area Headquarters	
METHOD (C)	
<i>Channel 1</i>	<i>Channel 2</i>
Army-Amateur station	Army Corps Area station
Army net control or Corps Area station	Army Message Center, Washington
Army Message Center, Washington	Red Cross Area Headquarters
Red Cross Area Headquarters	

METHOD (D)

<i>Channel 1</i>	<i>Channel 2</i>
Section control station	Coast Guard shore station
Master or alternate N.C.R. control station	Navy Department
Coast Guard shore station	Red Cross Area Headquarters
Navy Department	
Red Cross Area Headquarters	

All dispatches reporting a local disaster are to be actually addressed to and for action of the Commandant of the Naval District in which the disaster has occurred. In cases of very serious and wide-spread disasters, reports are to be sent to the national headquarters of the American Red Cross, Washington, D. C., in addition to the dispatch sent the Commandant, Twelfth Naval District, and to the local Red Cross Area Headquarters.

The American Red Cross has been very particular to describe the information which it requires when the first and second messages are filed, which is as follows:

First message—Report type of disaster, location and as much additional information as is immediately available.

Second message—Report (1) area covered by disaster; (2) number of persons dead; (3) number of persons injured; (4) number of persons temporarily homeless; (5) number of homes destroyed; (6) number of homes damaged; (7) number of families affected.

The frequencies guarded by Naval Shore Radio Stations at the time of writing of this article are shown below:

<i>Eastern</i>					
<i>Stations</i>	4040	4075	4235(S)	7995	8920
NAA/NSS	N	N	N	D	N
NAD	N			D	
NAH	N			D	
NAM	N			D	
NAR		N			
NAS		N			
NAO		N			
NAU					N
NBA					N
NAW					N
<i>Western</i>					
<i>Stations</i>	4010	4235(S)	4525(S)	8150	7995
NPC	N			D	
NPG	N	N		D	
NPL	N			D	
NPM		N	N		N

NOTES: Stations listed above transmit and receive on the above frequencies.

N—Indicates night only.

D—Indicates day only.

S—Harmonic series—appropriate frequency for day or night.

4235 kc. series is CinC. ship-to-shore frequency on both coasts.

12225 kcs. is used during day by NSS, NAR, NAS, NAO.

13305 kcs. is used during day by NSS, NAU, NBA, NAW.

This table of frequencies was effective 1 June, 1937, but is susceptible to changes from time to time that the requirements of the Service make necessary. It will be noted there are one or more stations that can be contacted on the east or west coast at almost any time of day or night in case of emergency, as these stations continuously guard some high frequency. The important thing to do is to pick out the proper frequency for the distance and time of day and then make sure that the transmitter is properly tuned so that the Navy operator at the receiving station will be able to hear the call on the frequency which he is guarding.

No attempt has been made to list the commercial high frequencies guarded by commercial shore radio stations, nor has any attempt been made to give frequencies guarded by Army-Amateur and Army Corps Area Headquarters stations. These frequencies may be changed from time to time, but it is usually possible for amateurs or Naval Reservists to identify certain of these stations at the time that they require their assistance. The Coast Guard operates a point-to-point circuit between Washington and its section base stations on 4050 and 8100 kcs., the lower frequency being used at night and the higher frequency in the daytime.

Now let us suppose that you are a Naval Reservist, for example in Louisiana, and it appears that a hurricane is liable to strike the coast town in which you live, during the next twelve hours. Just what would you do? You would contact the local chapter of the Red Cross, and further ascertain that the nearest Naval Radio Station continuously guarding a high frequency is located at Pensacola, Florida (NAS). If you had not already done so you would calibrate your transmitter and receiver to as close to 4075 kcs. as possible and would attempt to establish advance contact with Pensacola so as to be ready in case of serious damage when the hurricane struck. If for any reason you were unable to raise Pensacola you could call Norfolk, Virginia, (NAM) on 7995 kcs. and send a dispatch to Pensacola requesting them to listen for you on 4075. As soon as communication had been established, the Naval Radio Station would inform you on what frequencies they would listen for you and what schedules they would keep. The Commandant of the District would, in the meantime, in all probability have advised you by wire to be ready in case of emergency and instructed the Naval Radio Station to establish communication. That is what would happen in case of a predictable disaster.

In case of an unpredictable disaster such as an earthquake which might occur in Utah, there might be no commercial wire lines in operation after the shock and consequently no one would know what had happened. In this case your amateur station would attempt to raise any Naval

Radio Station on the west coast, preferably your own District Headquarters in San Francisco (NPG). If the earthquake had occurred during daylight hours you would call on 8150 kcs. or on 8470 kcs., whereas if the emergency occurred at night you would call on 4010 or 4235 kcs. Having once made contact with a Naval Radio Station, that station would take charge of the situation and instruct you what to do with regards to frequencies and maintenance of schedules.

Because the Section Control and the Master and Alternate Control Reserve stations are usually manned only on drill nights, except by special orders, these stations cannot be contacted in the case of an unpredictable emergency. However, in the case of a predictable emergency, the probability is that the Commandant of the District which expected a disaster would already have notified the personnel of these stations to man the stations and have them on the air, in which case you would be able to contact your Section or Master and Alternate Control Station on one of the Reserve frequencies, namely 3475 or 4045 kcs.

Some people have had the opinion that the Naval Communication Reserve was organized primarily for emergency operation in case of floods, hurricanes or other disasters, but this is actually not the case. The Communication Reserve is now made up of about 900 officers and 4300 men who have been enrolled in the Naval Reserve and are being trained for purposes of national defense. They are given regular instruction by means of drills and in other ways, in order to fit them to take their place with the Navy in case the need should arise. In order to provide this training, the Navy has developed this system of radio circuits by which naval procedure and methods are taught through practical radio operation. Naturally when a disaster occurs, the Naval Reserve personnel and their equipment are temporarily available to the Red Cross for relief purposes until regular channels of communication are again open. It is neither the desire nor the intention of the Navy Department to supersede commercial communication when such communication is available, nor is the Communication Reserve expected to operate after the regular Army, Navy, Coast Guard, National Guard or Naval Militia is prepared to handle emergency communication.

The purpose of the Red Cross Plan is primarily to bridge the gap of time which elapses between the time that the disaster occurs and the time that regular federal or state relief agencies can take charge and furnish necessary communication.

It might be interesting to readers of *QST* to know that, during the Ohio River and Mississippi Valley floods during the spring of this year, the Naval Communication Reserve control stations in Chicago, Cincinnati, Wheeling and Memphis handled a very large amount of relief traffic for

the Red Cross and for a time actually acted as the key stations for U. S. Coast Guard relief operations. This service continued in some cases for upwards of two weeks, although such long service was not contemplated by the original Red Cross Plan. It proved necessary because other channels of communication had not been reestablished. The vital usefulness, however, of the Red Cross Plan, comes in the first one or two hours of disaster when every minute is of importance in getting the word of the disaster to the Commandant and the Area Red Cross.

This plan has been given very wide distribution through the Red Cross, the Army, the Coast Guard and other branches of the government. Any amateur who is interested in helping out in case of emergency will do well to look up the nearest member of the Naval Communication Reserve and secure from him information with regards to identity of Navy and Naval Reserve stations in his locality, with the idea that this information may prove of great value in case of emergency.

Northwestern Division Convention

August 28th and 29th

RAINIER NATIONAL PARK! Sunrise Park, on the East Side of Mount Rainier, has been chosen for the 12th Annual Northwestern Division Convention to be held on August 28th and 29th, under the direct supervision of Director Ralph Gibbons and assisted by Harold W. Johnson. Cabins are \$2.00 and up, with or without blankets. A Cafeteria is also on the grounds. The registration fee is \$1.00. It will be necessary to register not later than August 15th, and this should be done by writing Harold W. Johnson, W7DXF, Box 527, Pendleton, Oregon; further information will also be furnished by him.

Pacific Division Convention

Stockton, Calif., September 4th-5th-6th

SEE you all in Stockton" is the heading which appeared in the Special Edition of the *Stockton Record* when the first publicity was released recently. The Stockton Amateur Radio Club joins in with the newspaper in extending a cordial invitation to all radio amateurs to attend the annual Pacific Division Convention to be held at the Hotel Wolf, Stockton, Calif., September 4th, 5th and 6th. A big program is being prepared and many features will appeal to all who come to the affair. One of the features which promises well, will be an initiation of the Royal Order of the Wouff Hong by members of the Manteca Radio Club. Watch for publicity, but if you want more information drop a card to George R. Scott, W6IKG, Hotel Wolf, Stockton, Calif.

A 56-Mc. Converter of High Stability

High-C Oscillator and High-Frequency I.F. for Reception of Crystal-Controlled Five-Meter Signals

By Byron Goodman,* W1JPE

MAJOR problem of 56-Mc. c.w. reception is that of obtaining a high-frequency oscillator that doesn't flutter and burble. One way is to use the harmonic of a lower-frequency oscillator, but this always leaves the gate wide open for reception of signals on another band, unless the signal circuits are quite selective—usually a very improbable condition at this frequency. Also, with ordinary methods of tracking, one ends up with an oscillator that is too low-C for good stability.

One angle of attack is so relatively simple that it is surprising that it has not been described

lower frequency, where the chances of its being stable are much better. And then it can be made real high C to increase the stability. The only problem left is that of ganging the high-C oscillator circuit and the low-C signal circuit or circuits. It is here that a very fortunate property of tuning capacities steps in and saves the day. A straight-line capacity condenser near the high-capacity end of its scale tunes practically straight-line frequency, so if we already have sufficient capacity in a circuit, a straight-line-capacity condenser will tune straight-line-frequency (or very nearly so) throughout its whole range. This holds true at any total capacity, of course, so long as the variable capacity is small compared to the fixed capacity. It is therefore a simple matter to design a low-C signal circuit that will track with a high-C oscillator circuit. This holds true for any intermediate frequency, but a high one was used in the set-up to be described to eliminate the possibility of images and to allow a lower oscillator frequency to be used.

A little scratching around on a pad of paper disclosed that with an intermediate frequency of 20.5 Mc. and a tuning range of 55.7 to 60.3 Mc. one should run into no image trouble. True, images might creep in from the range 14.7-19.3 Mc., but this would include no amateur signals (with the improbable exception of harmonics from the 80-meter band) and so any amateur

signals heard actually would be received on the 5-meter band. The simplest sort of 20.5-Mc. i.f. amplifier is an old t.r.f. receiver covering that range. A superhet could be used, but there would be too good a chance of running into oscillator harmonics from the receiver used as the i.f. An SW-3 served as the i.f. with the converter to be described, but any stable t.r.f. set will work quite well. If you don't mind dodging a few harmonics you can use your regular superhet.

Still more juggling, this time with condenser catalogs and the Lightning Calculator, gave the proper tuning condensers to be used. In the signal circuit, a range of 10.5 to 9.0 $\mu\text{fd.}$ covers the

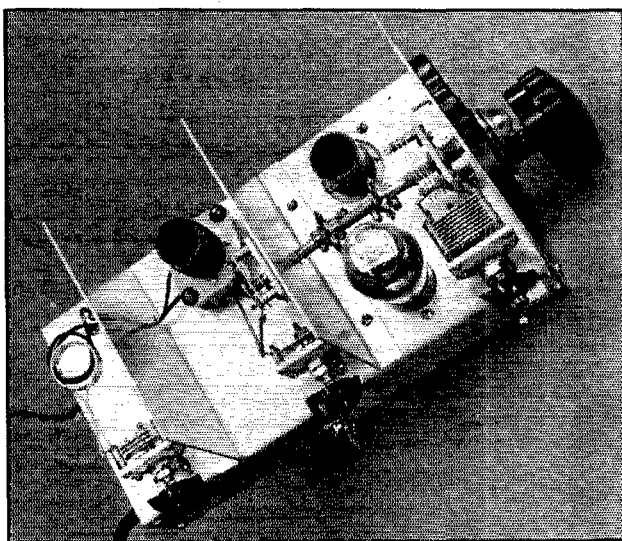

TOP VIEW OF THE 56-MC. CONVERTER

The front portion contains the oscillator tuning condenser and padding condenser, oscillator tube, and coil. The middle portion houses the detector tuning condenser and padding condenser, and detector coil. The acorn-tube detector is mounted directly under the detector coil socket, permitting a very short grid lead. The antenna tuning unit at the rear is link-coupled to the detector coil, and the antenna is clipped directly on to the coil. The output transformer is adjusted through the small hole under the link to the antenna coil.

before. The obvious solution to the image problem is to use a higher intermediate frequency. At the same time, if we put the oscillator on the low side of the signal frequency it will be on a much

* Assistant Sec'y, A.R.R.L.

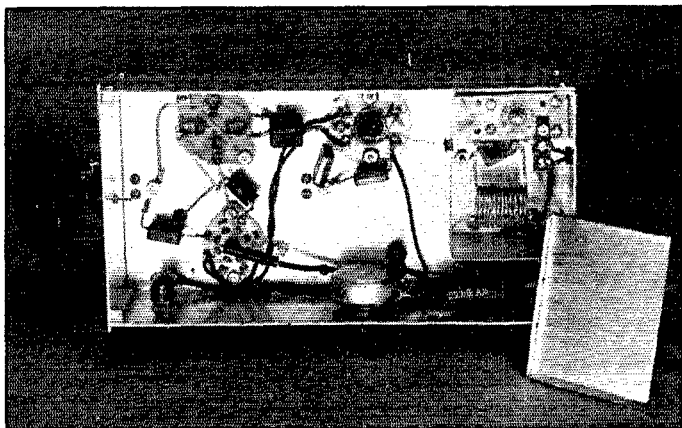

THE BOTTOM VIEW SHOWS THE OUTPUT TRANSFORMER WITH COVER REMOVED

Heavy leads are used to the oscillator circuit to maintain stability and to keep the lead inductance low. The output is taken through the twisted pair at the rear of the set.

range and gives nice low C; and for the oscillator, 113-90 $\mu\text{fd.}$ does the trick in covering the oscillator range of 35.2-39.8 Mc. These values were worked out backwards; the tuning ranges of various available condensers were listed and then the proper lumped capacity in the signal circuit range was found, so two plates were removed from a Cardwell ZS-4-SS, bringing its capacity range from 4-1.5 $\mu\text{fd.}$ down to 2.4-0.9 $\mu\text{fd.}$ Since the lumped capacity in the signal circuit was to be only 8.5 $\mu\text{fd.}$, the use of an acorn tube was indicated. It fits into the scheme well, since by mounting the tube under the socket taking the coil, the grid lead is cut down to about three-eighths of an inch. The 6J5G has been suggested as a stable high-frequency oscillator, and its use justified its reputation.

In order to squeeze the last microvolt of signal out of the detector stage, it was made regenerative. Also, because of the high intermediate frequency, cathode oscillator-coupling was used, and has shown absolutely no "pulling" effect. By using the coil that couples the oscillator to the detector as the cathode impedance for the regenerative detector, a simple and effective method of oscillator-

coupling and obtaining regeneration is secured. Regeneration is controlled in the usual manner, by varying the screen voltage.

Finally, a tuned antenna circuit was used, more efficiently to transfer energy from the antenna to the grid circuit. The tuned antenna circuit was link-coupled to the grid circuit, and the only necessary precaution to take is to see that the link is not made of twisted pair. An improvement in signal was apparent when wires separated about a half-inch were substituted for the twisted pair used at first.

The performance of the converter might well be improved by the addition of an r.f.

stage, but for reasons of economy and simplicity it was not included in this version.

CONSTRUCTION NOTES

The chassis for the converter is made by bending over 2 inches of each side of a 9 by 10 inch piece of aluminum, resulting in a U-shaped chan-

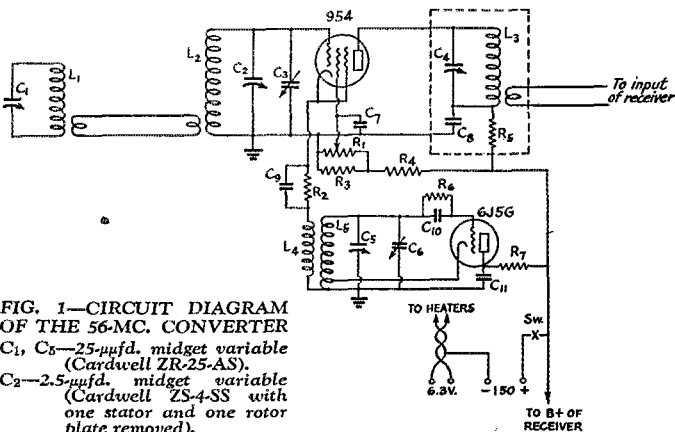

FIG. 1—CIRCUIT DIAGRAM OF THE 56-MC. CONVERTER

- C₁, C₅—25- $\mu\text{fd.}$ midget variable (Cardwell ZR-25-AS).
- C₂—2.5- $\mu\text{fd.}$ midget variable (Cardwell ZS-4-SS with one stator and one rotor plate removed).
- C₃—10- $\mu\text{fd.}$ midget variable (Cardwell ZR-10-AS).
- C₄—50- $\mu\text{fd.}$ midget variable (National UM-50).
- C₆—100- $\mu\text{fd.}$ midget variable (Cardwell ZU-100-AS).
- C₇, C₈, C₁₁—0.006- $\mu\text{fd.}$ postage-stamp mica condenser.
- C₉—250- $\mu\text{fd.}$ postage-stamp mica condenser.
- C₁₀—100- $\mu\text{fd.}$ postage-stamp mica condenser.
- R₁—50,000-ohm wire-wound potentiometer.
- R₂—2000-ohm, 1/2-watt carbon.
- R₃, R₄—15,000-ohm, 10-watt wire-wound.
- R₅—2500-ohm, 1/2-watt carbon.
- R₆—15,000-ohm, 1/2-watt carbon.
- R₇—5000-ohm, 1-watt carbon.
- L₁—4 turns No. 14, 1-inch diameter, 3/4" long.
- L₂—4 1/2 turns No. 18 enamelled, 3/4" long.
- L₃—12 turns No. 14, 1" diameter, 1 1/8" long, with 5 turns No. 26 d.c.c. wound inside for output coupling.
- L₄—2 3/4 turns No. 18 enamelled close wound at low-potential end of L₅.
- L₅—1 1/2 turns No. 18, 3/4" long, tapped 1/2 turn up for cathode. L₂, L₄, L₅ are wound on 1" diameter forms (National XR-1). The coupling coils for L₁ and L₂ are two turns each.

nel 5 by 10 inches. The front panel is made of a $5\frac{1}{2}$ by 7 inch piece, fastened to the base by tapped $\frac{1}{4}$ -inch square brass rod, and the rear end is made by bending over the ends of a small piece of aluminum so that it will fit tightly and bolting it to the chassis. The shield can for the output coupling transformer is made by bending thin aluminum to form a box $2\frac{1}{2}$ by $3\frac{1}{2}$ inches, with mounting tabs on the bottom, and another piece is bent to form a tight-fitting cover.

The general layout of parts is shown in the illustrations, and requires no special mention. The detector tube, a 954, has its socket mounted directly under the detector coil socket. It will be necessary to make two mounting pillars for the coil socket by tapping two 1-inch lengths of brass rod, since the acorn-tube socket partially covers the mounting holes for the pillars. Flat-head screws must be used. An acorn-tube socket similar to the one shown must be used, because it is necessary to keep the capacity between cathode and ground low.

The wiring is simple and straightforward, the only precaution being the usual one of making leads short and solid in the r.f. circuits. It will be noted in the diagram that the oscillator coil socket has two ground leads running from it, one to the oscillator tuning condenser and one to the detector tuning condenser. This was done so that the chassis would not have to be depended upon for the ground return. It is advisable to make the leads to the acorn tube grid and plate clips of fine wire, about No. 28, to eliminate the danger of breaking the tube when making connections.

The dial is an ordinary National Type "B" with a larger knob added. With the variable vernier ratio set all the way over towards "Slow," the dial gives smooth tuning and with a little care you will find that you won't miss any signals. You aren't tuning across four or five hundred kc. though, but over $4\frac{1}{2}$ megacycles and the tuning is fairly sharp.

The "on-off" switch is so wired into the circuits that it turns off both the converter and the receiver used as the i.f. amplifier.

TRIMMING THE COILS

Probably the most difficult task in the construction of the receiver is trimming the coils to their proper inductance. The first thing to do is to couple the output transformer to the receiver to be used as the i.f. amplifier. Couple the output of a modulated oscillator set at 20.5 Mc. to the 954 grid and tune in the signal on the receiver. Then tune the trimming condenser on the output transformer for maximum response. The i.f. amplifier is now lined up.

Set the test oscillator at 28 Mc. and set the tuning dial at 90. Rotating the oscillator padding condenser, the signal (second harmonic of the test oscillator) should be heard with the oscillator padder at almost exactly half scale. Then set the

test oscillator at 30 Mc. and see where the signal comes in on the tuning dial. If it's at about 5 on the dial, you have been very lucky and hit the proper range right off. A little trimming of the oscillator coil, about a quarter turn at a time, will soon give you the proper range.

Loosely couple the test oscillator to the antenna circuit and trim the detector coil. The detector padding condenser should be set at about $\frac{1}{3}$ scale to give exact tracking, but the antenna tuning will interlock slightly so it is not necessary to trim down to the last sixteenth of an inch of wire. If car noises peak up with the detector pad set at half scale or so the coil is adjusted closely enough.

Running the regeneration control up, the detector should oscillate at about $\frac{2}{3}$ scale. If it oscillates too soon, space the turns slightly on L_3 , the cathode impedance, until the regeneration works the way it should. It will be found that $\frac{1}{3}$ of a turn here will make the difference between "yes" and "no," so it is well to spend some time with the cathode coil.

With the set lined up properly, it will be possible to run across the band for c.w. signals with all of the ease and confidence customary on other bands. Any crystal-controlled signal will have the same stability that is obtained on 14 and 28 Mc., and you have the assurance that once found, it isn't going to flutter out of audibility almost immediately. Using the SW-3 as the i.f. amplifier, the regeneration control of the SW-3 is set in the sensitive position normally used for weak-signal reception, and held there for c.w. reception. It is backed off slightly for 'phone reception, in the usual manner.

When the rig is in operation, try changing the number of turns that link the output transformer to the receiver being used as the i.f. amplifier. Different receivers have different input impedances, and some adjustment of the coupling coil may be necessary if maximum sensitivity is to be secured.

Strays

Bustand's "Radio Instruments and Measurements", Circular 74, is back in print again, now reprinted with various errors and omissions corrected. In other respects it is still the same book which was once the experimenter's standby.

Why get excited over 56-Mc. DX? says W2GEI. According to May QST W8MAH has worked J2MH on 914,310 kc.—with a T9X signal, too! If you don't believe it, see page 61 of that issue.

It seems that W9UVJ was taken to task by his neighbors for broadcasting on kilocycles instead of megacycles, where said neighbors claimed he belonged!

Operating Data on the New Beam Power Tubes

A Two-Stage Beam Transmitter Using the RK-47

By George Grammer*

ACTUAL experience with the new beam transmitting tubes announced in our last issue—the RK-47 and RK-48¹—proves them to have the characteristics that have been found so desirable in their smaller prototypes. In plate current behavior, they are more like triodes than conventional pentodes, which means that more loading, and consequently more output, is possible at a given plate voltage. Under proper operating conditions, the plate efficiency is somewhat higher than with a pentode at the same plate input, another indication of improved performance.

The operating curves of Figs. 1 and 2 are of interest in indicating typical performance with variable excitation. With both types a grid current of 10 milliamperes is sufficient for full output when the recommended grid bias is used. The driving power is very low, being less than two watts for either type, and the tubes actually do drive well from a low-power source. The overall performance indicated by the curves is borne out very well in practice. With the RK-47, for instance, it is quite easy to obtain an output of 150 watts without exceeding the rated input, and the fact that an elaborate exciter is not needed not only makes the construction of a compact transmitter relatively easy, but greatly facilitates band-changing. Such a set is shown in the accompanying photographs; a rig using RK-48's is to be described in a following article.

The outfit pictured is an "all-beam" affair suitable for working three bands, 7, 14 and 28 Mc., with one crystal, and switching from one band to the other is accomplished simply by changing the

final tank coil. The driver is a 6L6 Tri-tet, working from a 7-Mc. crystal; the RK-47 is used as a straight amplifier on 7 and 14 Mc. and as a doubler on 28 Mc. The set-up is somewhat experimental in nature, because we were chiefly interested in getting some data on the performance of the tube under different operating conditions.

The conclusions can be stated briefly enough: The tube is well screened and shows no tendency

to oscillate without neutralization, and it makes a good doubler, although requiring higher bias in this application and therefore more driving power for most efficient operation. It is rather difficult to get a good $L-C$ ratio on 28 Mc. because the output capacity is high compared to that of a good high-frequency triode; the result is that, using the same tuning condenser that is suitable for 7 and 14 Mc., not all the power developed by the tube can be realized as useful output, since the relatively high

circulating tank current on 28 Mc. raises the tank losses. The output on 28 Mc. using the tube as a doubler runs between 60 and 75 watts, the lower figure being obtained when the input is adjusted so that the plate shows no color and the higher at the recommended maximum plate input—150 ma. at 1250 volts.

From the convenience standpoint the transmitter illustrated is a quite desirable arrangement. Fig. 3 gives the circuit diagram. The 6L6 plate circuit is proportioned so that both 7 and 14 Mc. can be covered with a single coil at L_2 , an arrangement which is not especially efficient but which is permissible in this case because the output of the 6L6 is far more than is needed to excite the RK-47. Changing L_2 is therefore unnecessary for operation on any of the three bands; C_1 is simply

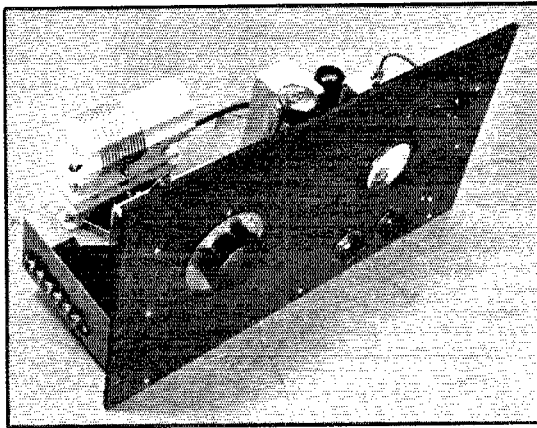

THIS TWO-TUBE TRANSMITTER WILL GIVE 150 WATTS OUTPUT ON TWO BANDS AND 75 WATTS ON THE THIRD

The RK-47 is used as a doubler at the highest frequency, 28 Mc. Two power supplies, one giving 100 milliamperes at 400 volts and the other 150 milliamperes at 1250 volts, are required.

* Assistant Technical Editor.

¹ "New Beam Power Tubes," July *QST*, page 18.

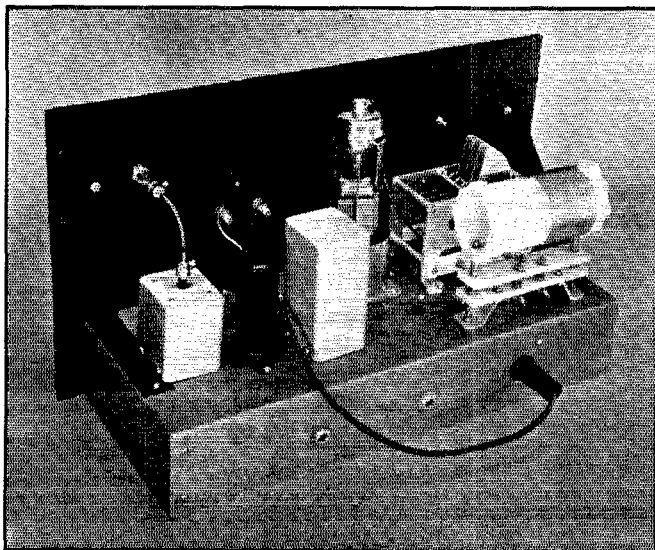

CHASSIS LAYOUT IS SIMPLE, AS THIS VIEW INDICATES

The oscillator plate coil, in the plug-in shielded coil box next to the 6L6, need not be changed for 7-, 14- and 28-Mc. operation, although made plug-in for flexibility. The transmitter can be adapted for 3.5-Mc. operation by substituting suitable coils.

swung to give resonance at either 7 or 14 Mc. The 6L6 is biased by a cathode resistor and grid leak combination, the leak being adjusted to give optimum harmonic output. The screen is fed through a dropping resistor and the plate is parallel-fed to avoid danger of flashing over the rather closely-spaced plates of C_2 and to avoid the necessity for insulating C_2 from the chassis. Series feed is used in the RK-47 grid circuit, a blocking condenser C_6 being inserted in the 6L6 plate tank to insulate the bias voltage from ground. Resistor R_5 is a grid leak used only when doubling in the final; it is shorted by switch S when the tube is a straight amplifier. The 15,000-ohm value specified was found to be optimum in this particular circuit arrangement. The RK-47 plate circuit is conventional. The screen is supplied through R_6 from the oscillator plate supply.

Only one other point about the circuit needs comment. In the early experimental work, parallel feed to the RK-47 plate was used, and proved to be entirely satisfactory on 7 and 14 Mc. However, on 28 Mc. the plate choke ran hot and the efficiency was

low. The difficulty of securing a single choke which would work well on all three bands finally forced the use of series feed, but on installing the latter we ran into r.f. troubles in the plate-supply leads and on the supposedly "cold" chassis. The most effective cure was the installation of C_7 across the meter jack and C_{10} from the cold end of the 6L6 plate choke to ground. After these condensers were put in there was no further trouble of this type.

The physical layout is quite simple. Viewed from the back, at the left is the socket for the crystal, followed by the 6L6 and the socket for the 6L6 plate coil. These are toward the rear of the chassis, leaving space in the front for mounting the plate meter on the panel. The RK-47 is set in a socket suspended below the chassis so that the grid leads are entirely "underground." A shield can with the top cut off surrounds the lower part of the tube to provide further shielding. The plate tank condenser and coil are at the right. The jacks for reading plate currents and RK-47 grid current are mounted on the rear edge of the chassis; the two at low voltage are insulated by fibre washers and the high-voltage one by a piece of bakelite mounted so that the jack projects through a hole of ample size in the chassis.

The crystal holder shown in the photograph is a new National multiple unit, with an internal switch, holding four crystals. The switch shaft is connected to a panel control by means of a flexible-cable coupling so that any of the crystals can

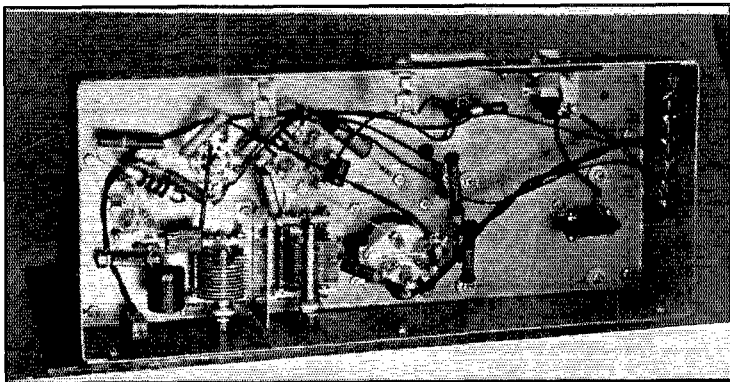

PRACTICALLY ALL WIRING IS UNDERNEATH THE CHASSIS
The layout affords complete shielding without any special constructional work.

be selected from the front. The holder fits a standard five-prong socket and can be pulled out in an instant should it be necessary to use an extra crystal provided with the customary mounting. The 6L6 plate coil is an air-wound affair cemented on celluloid strips and mounted inside a shielded plug-in coil box. The shield is grounded through one of the five pins on the coil base.

The usual collection of r.f. chokes, by-pass condensers and resistors is to be found underneath the chassis. C_1 and C_2 are mounted upside down from the lower side of the chassis top, with their shafts projecting through holes in the front. The oscillator cathode coil, L_1 , is to the left of C_1 ; it is mounted simply by No. 14 wire leads, soldered through holes in the bakelite form, which go to convenient soldering lugs. A small baffle shield is placed between the two condensers. All r.f. leads are as short as possible, with grounds directly to the chassis. The final tank condenser is insulated from the chassis by means of small butt-in type insulators.

The chassis is electroalloy, 7 by 17 by 3 inches, and the panel 10½ by 19 by ¼ inches, the dimen-

sions being suitable for relay-rack mounting.

For minimum crystal current it is essential that the dimensions of L_1 be duplicated and that C_1 be set as near minimum capacity as is con-

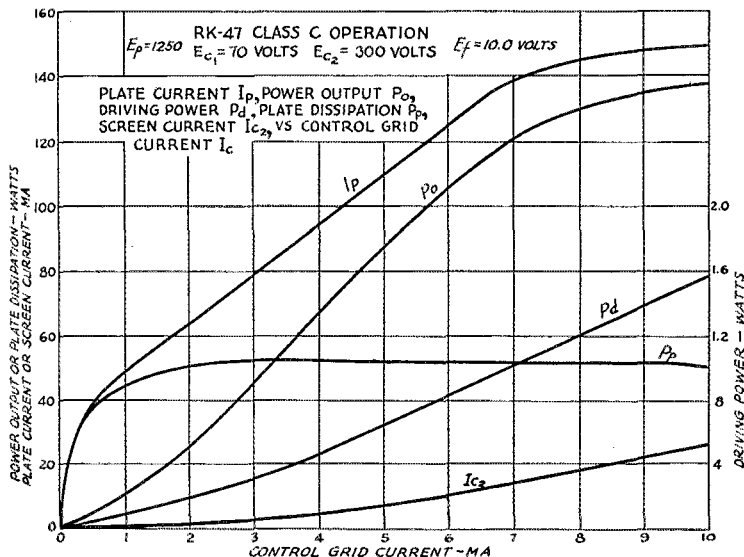

FIG. 1—OPERATION CURVES OF THE RK-47
Plate current, power output, plate dissipation, driving power and screen current plotted against d.c. grid current.

sistent with the excitation required. Crystals of ordinary activity will work well with C_1 set right at minimum, and this control in nearly all cases may be left alone. The setting for 7-Mc. output will be found near maximum capacity on C_2 , and for 14-Mc. output near minimum capacity. The 6L6 plate current at resonance will be about 60

milliamperes in either case, using the 400 volts specified in Fig. 3. A neon bulb touched to the crystal shows only a dim glow, and the crystal is only slightly warm after long periods of operation. Most of this heat is transmitted from the tubes through the chassis.

In the RK-47 stage, with R_5 shorted out, the unloaded minimum plate current on 7 Mc. should be about 15 ma. and on 14 Mc. about 25 ma., the difference being accounted for by the fact that the $L-C$ ratio is less favorable on 14 Mc. Doubling to 28 Mc., with R_5 in the circuit, the minimum plate current

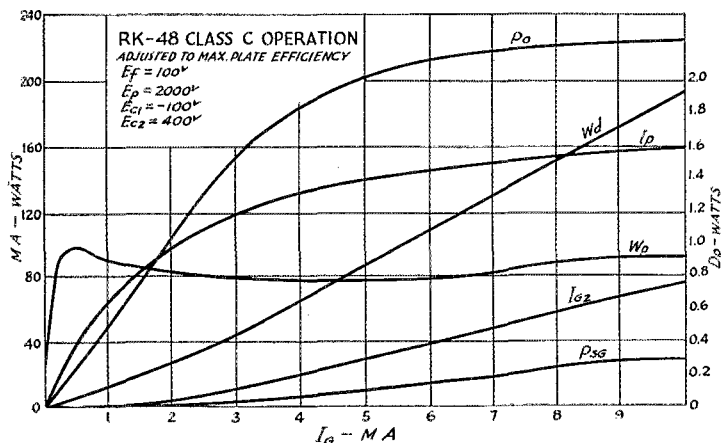

FIG. 2—RK-48 OPERATING CURVES
Power output, P_o ; plate current, I_p ; driving power, P_d ; plate dissipation P_p ; screen-grid current, I_{c2} ; and screen-grid power, P_{sg} , as a function of d.c. grid current.

should be about 60 ma.; the tank can be loaded until the tube takes 120 ma. without color showing on the plate. At 150 ma. the plate gets pink, but the output is somewhat higher, as already mentioned. On 7 and 14 Mc., there is no sign of color on the plate at the rated plate current of 150 ma. It will be found that the output power increases rapidly as the grid current is increased from zero to about 5 milliamperes, after which the change is more gradual. Running the

ohm resistor in series with the RK-47 screen should be cut out.

An alternative method of operation is to use 3.5-Mc. crystals, driving the RK-47 as a straight amplifier from either the second or fourth harmonic of the oscillator. With 400 volts on the oscillator plate, the fourth harmonic is large enough to provide adequate excitation when one of the low-drift crystals is used. The older X cuts do not have as great activity—at least this was

the case with several samples tried—for good fourth-harmonic operation. The cathode coil for an 80-meter crystal should have 15 turns in the same space as the specified 40-meter coil occupies. Incidentally, the latter coil is sufficiently large so that 20-meter crystals of the "harmonic" type can be used in the transmitter for 14- and 28-Mc.

No antenna-coupling circuit is indicated in the diagram, since most amateurs have their own pet schemes. There is ample room on the forms for a link, or even for a coupling coil to be used with series or parallel tuning. The spacing between such coils can be adjusted so the tank and antenna coil for a given band can be plugged in together.

The transmitter could be adapted for 3.5-Mc. operation by substituting suitable crystals and a larger coil at L_2 . One difficulty is that of securing a large enough final tank coil without resorting to another type of form; a second is that the $L-C$ ratio becomes

unduly high on this band with the tank condenser specified. Unfortunately, however, we run up against the physical fact that a condenser suitable for 14 and 28 Mc. is invariably too small for the lowest frequencies, and that one large enough for 3.5 Mc. has too much residual capacity for 28 Mc. We hope some day that condensers manufacturers can be persuaded to make a fixed air condenser of reasonable voltage rating which can be incorporated in a regular plug-in coil assembly so that this business of $L-C$ ratios in wide-frequency-range transmitters will be less troublesome.

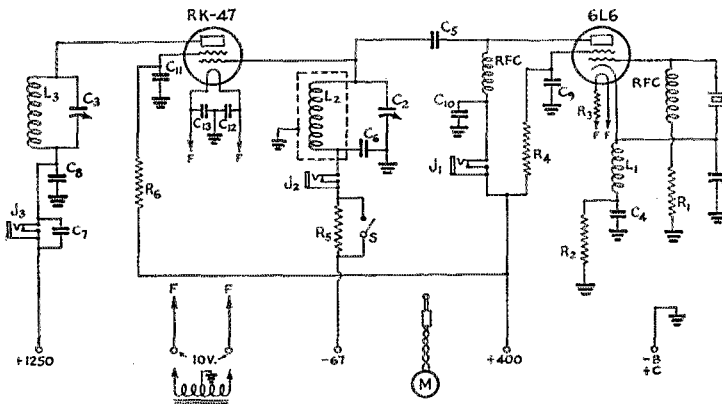

FIG. 3—CIRCUIT DIAGRAM OF THE TWO-STAGE BEAM-TUBE TRANSMITTER

- C_1 —100- μ fd. variable (National ST-100).
- C_2 —250- μ fd. variable (National STH-250).
- C_3 —50- μ fd. transmitting type, airgap 0.171" (National TMA-50A).
- C_4 —0.005- μ fd. mica, receiving type (Dubilier).
- C_5 —500- μ fd. mica, 1000-volt (Aerovox Type 4).
- C_6, C_7 —0.002- μ fd. mica, receiving type (Aerovox).
- C_8 —0.002- μ fd. mica, 5000-volt (Sangamo).
- C_9-C_{10} , inc.—0.01 paper, 600-volt (Aerovox and Sprague).
- R_1 —100,000 ohms, 2-watt (IRC).
- R_2 —400 ohms, 2-watt (IRC).
- R_3 —5-ohm adjustable wire-wound (Electrad).
- R_4 —25,000 ohms, 10-watt (IRC Type AB).
- R_5 —15,000 ohms, 10-watt (Ohmite).
- R_6 —4000 ohms, 10-watt (IRC Type AB).
- J_1, J_2, J_3 —Closed-circuit jacks (Yaxley).
- RFC—Receiving-type chokes (National R-100).
- M—0-200 d.c. milliammeter (Weston 301).
- L_1 —For 7-Mc. crystal, 8 turns No. 22 on

- 1-inch form, spaced to make length 1 inch.
- L_2 —17 turns No. 14, outside diameter 1 inch, spaced to make length 2 inches. (Mounted in National Type PB-10 5-prong coil base and shield.)
- L_3 —7 Mc.: 14 turns No. 14, diameter 2 1/4 inches, length 2 inches. 14 Mc.: 6 turns No. 14, diameter 2 1/4 inches, length 1/2 inch. 28 Mc.: 3 turns No. 14, diameter 2 1/4 inches, length 2 1/2 inches.

All wound on National XR-10A forms with PB-15 plug bases to fit XB-15 jack base. The 7- and 14-Mc. coils are wound in consecutive grooves; the 28-Mc. coil in every sixth groove.

R_3 should be adjusted to drop the 6L6 filament voltage to 6.3 volts from the 10-volt source.

The 6L6 shell and RK-47 beam-forming plates are connected directly to ground. The 6L6G is not recommended for this circuit, as the crystal current runs considerably higher than with the 6L6.

grid current over 10 milliamperes does no good so far as output is concerned.

The fixed bias, approximately 70 volts, may be secured from batteries or from a power pack. This value is for Class-C operation, and is greater than cutoff so that no plate current flows when excitation is absent.

If 28-Mc. operation is not wanted, a 300-volt supply will be sufficient for the oscillator. The lower voltage gives the crystal even less work to do, and provides ample excitation for the RK-47 as a straight amplifier. With 300 volts, the 4000-

A DeLuxe 'Phone Transmitter With Grouped Controls and Cable Tuning

An Innovation in Transmitter Construction for Convenience and Protection of Controls

By S. L. Baraf* and Frank Edmonds,* W2DIY

IN THE past few years an abundance of ideas and equipment has been presented to amateurs who wish to occupy as many bands as possible with a minimum of time taken out for changing from one to another. There are, however, many in the amateur fraternity who derive their chief enjoyment from reliable daily contacts on the same band. These amateurs number among them some of the hardest workers and most unselfish operators in times of emergency; a large part of their value comes from the fact that they have built up stations which

can be depended upon to be on the air at a definite frequency and to put out a high-quality signal. The speed and precision with which these fellows handle traffic during emergencies is well up to the standards of the best commercial services.

With these thoughts in mind, a transmitter was designed having features that should appeal greatly to those amateurs who confine themselves largely to single-band operation. To begin with, a rather unusual design feature in the transmitter is the cable tuning. The tuning controls are grouped to facilitate tuning and to protect them from being disturbed, once set. Moreover, once the transmitter is tuned up the tuning controls are no longer of importance and in this particular arrangement they least distract the operator's eye when observing the operation of the transmitter. It will be noticed that all essential tuning controls are symmetrically arranged on an inclined panel. The controls ordinarily cannot be tampered with because of a glass door which when in closed position protects them from accidental mis-adjustment. It will also be

* United Transformer Corp., 72 Spring St., New York City.

noticed that the meters are grouped at the top so that the operator does not have to search all over the panel while tuning up the transmitter. Now then, looking at the front of the transmitter, it can be realized that with the glass door closed the meters and the oscilloscope predominate, with the line voltage control on the front bottom also in view.

Having gone to such exacting design details it is only natural to state how it was possible to group all controls and meters symmetrically without the use of many name plates and dials. The

writers found that it did not cost any more to anodize the front aluminum panels and then have them engraved with the necessary circuit designations and differently assigned dial divisions for the tuning controls. Mounting screws for the panels are hidden from view by trim strips so that a finished "professional" appearance is attained. To enhance the operating convenience of the transmitter, provision is also made for remote operation.

A glance at the rear-view photograph of the transmitter will show how it was possible to group the tuning controls. This was accomplished by introducing the use of flexible tuning cable of the type used in remote controls for auto radios. This cable will readily handle the larger transmitter tank condensers, provided the cable housing is clamped securely so that there is extremely little whip. A particular advantage in cable tuning is the fact that the tank condensers may be placed in any position necessary for maximum efficiency, without regard to panel layout.

To provide safety and convenience all controls and meters are at ground potential, and the transmitter is completely relay operated.

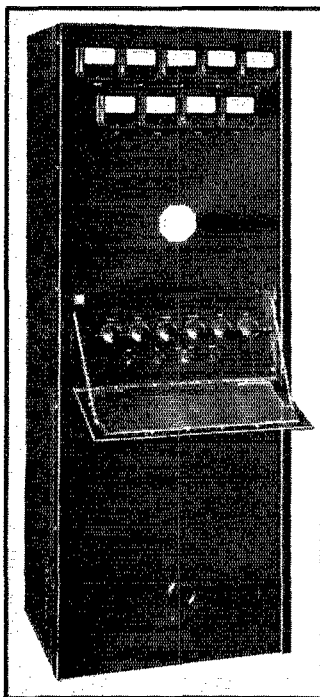

THE USUAL ARRAY OF DIALS AND CONTROLS ALL OVER THE TRANSMITTER PANEL IS CONSPICUOUS BY ITS ABSENCE

Remote tuning by means of flexible cables permits grouping all tuning controls at one easily-accessible spot. Once the transmitter is tuned, the drop panel, which has a glass insert, is closed so that the controls cannot be touched.

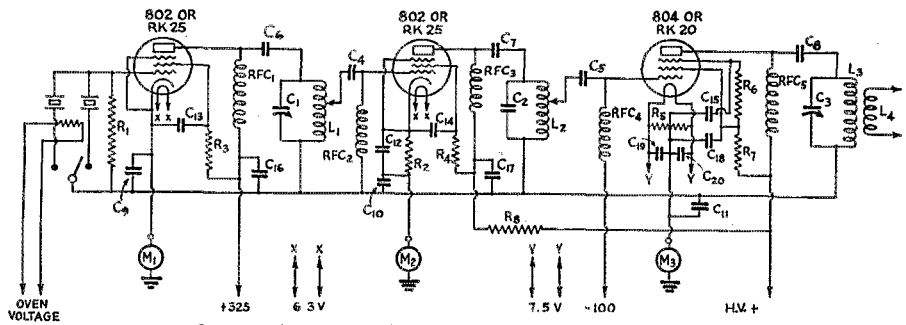

FIG. 1—CIRCUIT DIAGRAM OF THE EXCITER UNIT

- C_1, C_2, C_3 —100- μ fd. variable (Cardwilt MT-100-GS).
- C_4, C_5 —100- μ fd. mica, 1200-volt (Cornell-Dubilier Type 9).
- C_6, C_7 —0.002- μ fd. mica, 1200-volt (C-D Type 9).
- C_8 —0.002- μ fd. mica, 2200-volt (C-D Type 9).
- C_9 —C20, inc.—0.01- μ fd. tubular, 2000-volt (C-D VC-SI).
- R_1 —40,000-ohm, 2-watt.
- R_2 —1500-ohm, 20-watt.
- R_3, R_4 —20,000-ohm, 20-watt.
- R_5 —50-ohm, 10-watt.

- R_6 —50,000-ohm, 10-watt.
- R_7 —20,000-ohm, 20-watt.
- R_8 —4000-ohm, 20-watt.
- RFC₁, RFC₂—Receiving-type chokes (Hammarlund CHX).
- RFC₃, RFC₄, RFC₅—Sectional-wound chokes (Hammarlund CH-8).
- M_1, M_2 —0-100 d.c. milliammeter (Triplett 421).
- M_3 —0-200 d.c. milliammeter (Triplett 421).
- L_1 —3.5 Mc.: 22 turns No. 18, diameter 2 1/4 inches.
- 7 Mc.: 14 turns No. 18, diameter 2 1/4 inches.

- 18, diameter 2 1/4 inches.
- L_2 —3.5 Mc.: 22 turns No. 18, diameter 2 1/4 inches.
- 7 Mc.: 14 turns No. 18, diameter 2 1/4 inches.
- 14 Mc.: 8 turns No. 18, diameter 2 1/4 inches.
- L_3 —3.5 Mc.: 22 turns No. 16, diameter 2 1/4 inches.
- 7 Mc.: 14 turns No. 16, diameter 2 1/4 inches.

- 14 Mc.: 8 turns No. 16, diameter 2 1/4 inches.
- L_4 —Link windings, 5 turns (should be determined experimentally to give optimum coupling).
- Taps on oscillator and first buffer plate coils are taken off approximately one-fourth the number of turns, counted from the ground end. All coils wound on Bud grooved bakelite forms.
- Key may be inserted in oscillator cathode circuit.

R.F. SYSTEM

Electrically, the r.f. section of the transmitter consists of four stages, which provide adequate isolation of the crystal oscillator and ability to operate the transmitter on the 20-, 40- and 80-meter bands by the use of the proper crystals and plug-in type coils. The buffer and driver stages use pentodes because of the low driving power required and the freedom from neutralizing troubles. The output stage is the conventional push-pull triode arrangement, which gives maximum efficiency with high-level plate modulation and because of its balanced construction permits permanent neutralization. The crystal stage uses a pentode operating at low plate potential. This circuit was chosen because of the fact that the pentode requires a minimum of crystal current, and since no large power output was required to excite the following pentode, the crystal stage was designed for maximum frequency stability. The use of the pentode oscillator together with temperature crystal ovens and operation of the oscillator at low voltage makes possible an oscillator whose frequency stability is comparable to that of the better commercial stations.

The second stage is a straight pentode buffer. The driver stage, however, contains an interesting feature for those who have had difficulty in deciding how to obtain operating potentials for this type of tube. In order to obtain the maximum output from the RK-20 with the lowest plate potential it was decided to operate this tube with positive potential on the suppressor grid. A number of operators have been at a loss as to a method for obtaining this suppressor potential without

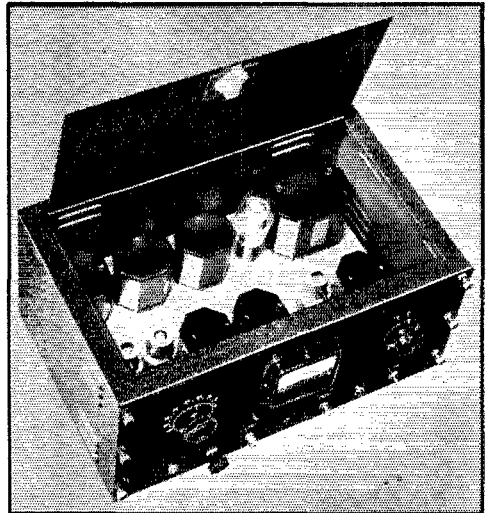

THE REMOTE AMPLIFIER CONTAINS THREE LOW-LEVEL SPEECH STAGES, WITH PROVISION FOR A CRYSTAL MICROPHONE OR INPUT FROM A LOW-IMPEDANCE LINE

Control switches for the transmitter also are brought to this unit so they are readily accessible from the operating position.

taking taps from one of the low-voltage power supplies, which requires some fishing for the proper location of this tap and the use of an additional power lead to the tube. This difficulty was solved by the use of another dropping resistor from the screen to the suppressor. For an RK-20

FIG. 2—THE PUSH-PULL FINAL AMPLIFIER AND ANTENNA COUPLER

- C₁—100- μ fd. per section split-stator (Cardwell MT-100-GD).
- C₂—110- μ fd. per section split-stator (Cardwell XG-110-KD).
- C₃, C₄—250- μ fd. transmitting type (Cardwell XE-240-KS).
- C₅—0.01- μ fd. tubular, 2000-volt (Cornell-Dubilier VC-51).
- C₆—0.002- μ fd. mica, 5000-volt (C-D Type 9).
- C₇, C₈—0.01- μ fd. tubular, 2000-volt (C-D VC-51).
- C₉—8- μ fd. paper, 400-volt (C-D PEC-4008).
- C₁₀—0.002 mica, 1200-volt (C-D Type 9).
- R₁—100-ohm, 20-watt.
- M₁—0.100 d.c. milliammeter (Triplet 421).
- M₂—0.500 d.c. milliammeter (Triplet 421).
- M₃, M₄—0.2.5 r.f. ammeters, external thermo-couple type (Triplet 421).
- RFC—Transmitting choke (Hammarlund CH-500).

- L₁—3.5 Mc.: 36 turns No. 16, diameter 2 1/4 inches (Bud grooved form).
- 7 Mc.: 24 turns No. 16, diameter 2 1/4 inches (Bud grooved form.)
- [14 Mc.: 14 turns No. 16, diameter 2 1/4 inches (Bud grooved form).
- L₂—Link winding, 4 turns (should be adjusted experimentally to give optimum coupling).
- L₃—3.5 Mc.: 30 turns No. 10, diameter 3 inches, 6.4 turns per inch.
- 7 Mc.: 20 turns No. 10, diameter 3 inches, 6.4 turns per inch.

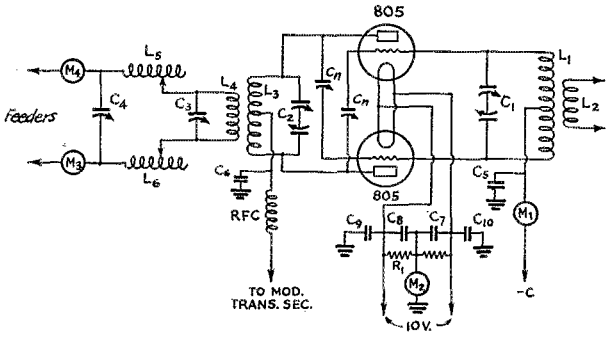

- per inch.
- 14 Mc.: 12 turns No. 10, diameter 3 inches, 6.4 turns per inch.
- (Wound on Bud Type 376 ceramic forms.)
- L₄—Antenna pickup coil, 6 turns wound between sections of L₃.
- (L₂ is wound in two sections to accommodate L₄ at the center.)
- L₅, L₆—24 turns No. 12, diameter 2 1/2 inches, length 4 inches, tapped every second turn. (On Bud Type 383 ceramic form.)

operating at 1000 volts on the plate this resistor should have a value of 50,000 ohms.

The layout of the final stage is conventional except for the method of connecting the neutralizing condensers. Instead of the customary

cross connecting the neutralizing condensers are connected straight through and the plate leads are cross-connected. This permits shortening the leads to the neutralizing condensers by several inches and does not materially increase the length

of the plate leads because the plate connections are at the tops of the tubes. It will also be noticed that the filament center tap is by-passed to ground with two condensers; one of these is an 8- μ fd. unit, C₉, used to by-pass the audio modulation because the plate meter is connected at this point, while the other is a 0.002- μ fd. mica condenser used to by-pass the r.f. If it were not for the inductive reactance of the 8- μ fd. condenser the second condenser would not be necessary, but unfortunately the large-capacity condensers have considerable inductance at high frequencies. It was found advisable to make all ground returns in this stage to the same point; returning one of the by-pass condensers to a point only a few inches away from the common ground point is likely to result in unstable operation and difficulty in neutralizing. The antenna-coupling system used is of the well-known low-pass type.

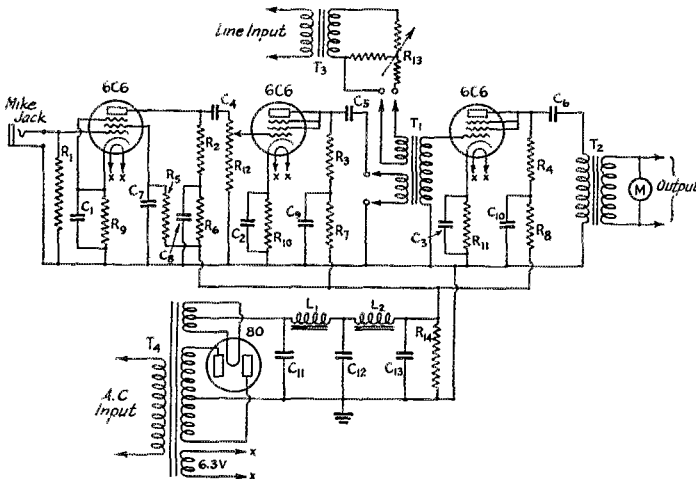

FIG. 3—THE PRE-AMPLIFIER UNIT AND POWER SUPPLY

- C₁, C₂, C₃—20- μ fd., 25-volt electrolytic (Cornell-Dubilier ED-2100).
- C₄—0.25- μ fd., 400-volt paper (C-D DT-4P25).
- C₅—C₁₀, inc.—1- μ fd., 400-volt paper (C-D DT-4W1).
- C₁₁, C₁₂, C₁₃—8- μ fd., 450-volt electrolytics.
- R₁—5-megohm, 1-watt.
- R₂—250,000-ohm, 1-watt.
- R₃, R₄—30,000-ohm, 1-watt.
- R₅—50,000-ohm, 1-watt.
- R₆—500,000-ohm, 1-watt.
- R₇, R₈—50,000-ohm, 1-watt.
- R₉—5000-ohm, 1-watt.
- R₁₀, R₁₁—2000-ohm, 1-watt.
- R₁₂—250,000-ohm potentiometer.
- R₁₃—500-ohm "T" pad, line gain-control.
- R₁₄—20,000-ohm, 20-watt.
- T₁—Audio coupling transformer; single plate (high-impedance) and microphone (low-impedance) to grid (UTC PA-136).
- T₂—Triode plate to line transformer (UTC PA-140).
- T₃—Mixing transformer, line-to-line (UTC PA-137).
- T₄—Power transformer; 300 each side c.t., 75 ma.; 6.3 volts, 2 amp.; 5 volts, 3 amp. (UTC PA-17985).
- L₁, L₂—Filter chokes, 50-henry, 50-ma. (UTC PA-17986).
- M—level indicator, -10 to + db (Triplet 441).

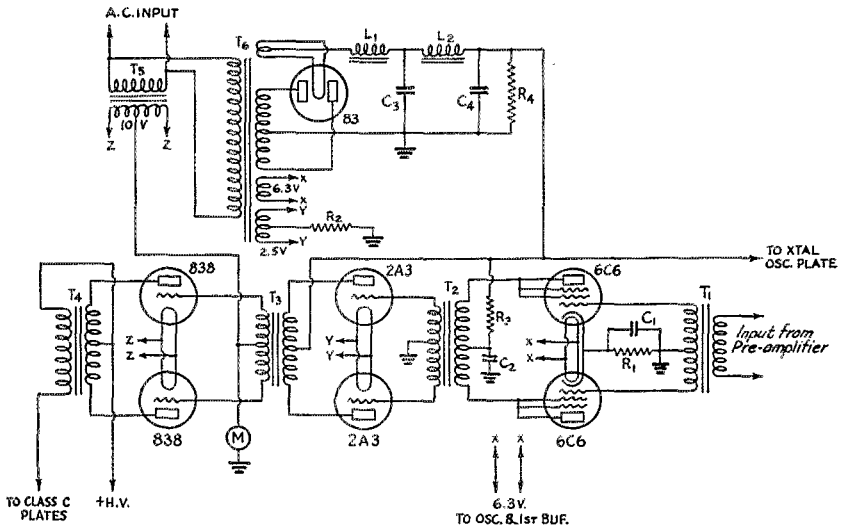

FIG. 4—THE CLASS-B MODULATOR AND DRIVER

C_1, C_2 —1 μ d., 400-volt paper (Cornell-Dubilier DT-4W1).
 C_3, C_4 —Paper replacement for 8-8 μ d. 600-volt electrolytic (C-D PE-6808).
 R_1 —1500-ohm, 10-watt.
 R_2 —400-ohm, 10-watt.
 R_3 —50,000-ohm, 1-watt.

R_4 —20,000-ohm, 50-watt.
 T_1 —Line to push-pull grids transformer (UTC PA-135).
 T_2 —Interstage audio, one plate to push-pull grids; ratio 2:1 each side (UTC A-132).
 T_3 —Class-B input, 2A3's to

838's; (UTC PA-53-AX).
 T_4 —Class-B output, variable ratio (UTC VM-4).
 T_5 —Filament transformer, 10 v. at 7 amp. (UTC PA-124).
 T_6 —Power transformer; 400 volts each side c.t., 200 ma.; 2.5 v. at 6 amp.;

6.3 v. at 4 amp.; 5 v. at 3 amp. (UTC PA-426).
 M —0-500 d.c. milliammeter (Triplett 421).
 (The 6C6 stage may be omitted if desired, since the total gain without it is ample for ordinary crystal microphones.)

Four power supplies are used in the transmitter proper, one for the speech amplifier and oscillator, a second for the buffer and driver stages, a third for the bias supplied to the final and driver stages, and a fourth for the power amplifier and modulator. There is also a fifth supply, for the oscilloscope. The power supply for the final r.f. and modulated amplifier is capable of delivering a full kilowatt at 1300 volts. Four 866A's are used in this supply, with a balance coil between the parallel tubes on each side to provide an equal division of current to the rectifiers. Without the use of the balance coil one of the tubes would take most of the current; moreover the use of the balance coils avoids the use of more expensive 872 rectifier tubes. A liberally designed Vari-Power autotransformer, 2000-watt rating, is used to compensate for line voltages from 95 to 130 volts. When this transformer is adjusted to provide the proper voltage at the power amplifier tube filaments, the proper operating voltage is also provided at the other transformers. The transmitter is completely protected by relays so connected that opening of the rear door or tampering with the auto-transformer while the transmitter is in operation will automatically shut down the transmitter. Overload of the power amplifier tubes will cause the high-voltage plate supply to be shut off but will leave the filaments and low-voltage supplies in operation. An eight-terminal connector at the rear of the transmitter provides for op-

eration of the transmitter from a remote point.

The audio system in the transmitter proper consists of the modulator and driver stages. The a.f. input to the transmitter is to a two-connection plug terminal at the rear; this connector runs to a five-terminal strip at the rear of the amplifier deck with provision for input impedances of 50, 200 or 500 ohms. The input stage consists of push-pull 2A3's, which are still the best available tubes for use as Class-B drivers.

It has been noticed that there is an increasing tendency on the part of amateur constructors to resort to the use of new type tubes for this type of service merely, it is assumed, because of the desire to use the latest in tubes when constructing a new rig. If really high-quality transmission is desired it is highly advisable to use driver tubes with a low plate resistance. Tubes such as the 2A3, the 6A3, the new 6A5G or the 845 fall in this class. Tubes such as the 6L6 and the 6B5, while they make very good output amplifiers, have a plate resistance much too high to meet the requirements for Class-B drivers and should be avoided for this service.¹

¹ The desirable effects of high plate resistance with tetrode and pentode tubes can be overcome by use of inverse feedback, which in effect lowers the plate resistance of the tube. See "Some Practical Inverse Feedback Circuits for Audio Power Amplifiers," QST, January, 1937. The use of inverse feedback requires a higher value of driving signal, however, so that the operating conditions are comparable to those of low-mu triodes.—EDITOR.

The modulator tubes selected for the transmitter were the familiar 838's. By increasing the input slightly over rated conditions these tubes are capable of 300 watts of high-quality audio. The multiple taps on the Varimatch modulation transformer proved to be very handy when the transmitter was first tested out. It was found that when tuned up the transmitter was capable of an output of 400 watts at eighty meters but that the wave form, as viewed on the oscilloscope, was slightly distorted at the high frequencies. Upon checking over the transmitter it was found that the plate voltage was slightly higher than had been anticipated and under this condition the matching of the modulator to the Class-C stage was not as close as it should be for high-quality transmission. It was a simple matter to correct this condition by reconnecting the taps on the modulation transformer to provide a closer impedance match.

THE OSCILLOSCOPE

The oscilloscope used in the transmitter uses a separate power supply and provides for both trapezoidal and envelope type patterns. The circuit is conventional, and needs no particular comment. A 60-cycle sweep is provided. Much has

been written about the oscilloscope so the experienced operator does not have to be convinced as to the advantages of incorporating the 'scope in a high-quality transmitter. As used in this transmitter the 'scope can be used for a complete check on the rig when tuning up. The 60-cycle sweep is useful in checking the neutralization of the Class-C stage, and with the aid of an external linear sweep oscillator and an audio-frequency generator the entire audio system may be checked over to determine gain, frequency response and quality of the audio amplifier system. When the transmitter is in operation the operator has his choice of either the envelope or trapezoidal pattern as a constant check on percentage of modulation. The writer prefers the envelope pattern as this enables one to observe both the percentage of modulation and the wave form at the same time.

THE REMOTE AMPLIFIER

The remote amplifier shown provides for remote control of the transmitter from the operating position and for either a crystal microphone or low impedance line input. Three stages are provided in the remote amplifier; all stages are used with the crystal microphone, but only one stage is used with the low-impedance line. Switch-

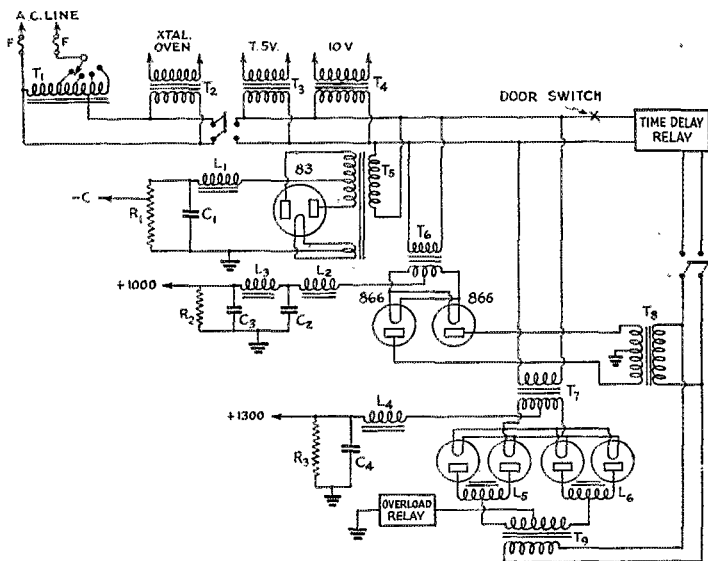

FIG. 5—ESSENTIAL DIAGRAM OF BIAS AND HIGH-VOLTAGE POWER SUPPLIES

For simplicity, some of the details of the control wiring have been omitted.

C₁—8- μ fd., 600-volt paper (3 Cornell-Dubilier Type PE-6808 in parallel).

C₂, C₃—2- μ fd., 1500-volt (C-D TJ-15020).

C₄—4 μ fd., 2000-volt (C-D TJ-20040).

R₁—1000-ohm, 200-watt.

R₂—50,000-ohm, 100-watt.

R₃—100,000-ohm, 200-watt.

T₁—Tapped auto-transformer (VA-5).

T₂—Oven transformer, 10 v. at 2 amp. (PA-18442).

T₃—Filament transformer, 7.5 volts at 3 amp. (PA-28).

T₄—Filament transformer, 10 volts at 7 amp. (PA-124).

T₅—Bias supply transformer, 200 v. each side c.t., 5 v. at 3 amp. (PA-18083).

T₆—Rectifier filament trans., 2.5 volts at 10 amp. (PA-34).

T₇—Rectifier filament trans., 2.5 volts at 20 amp. (PA-120D).

T₈—Plate transformer, 1250 volts each side c.t., 200 ma. (PA-116).

T₉—Plate transformer, 1500 volts each side c.t., 1 amp. (PA-119).

L₁—Filter choke, 10 henrys,

200 ma. (PA-102).

L₂, L₃—Filter choke, 12 henrys, 250 ma. (PA-104).

L₄—Filter choke, swinging, 5-25 henrys, 100-1000 ma. (PA-1C).

L₅, L₆—Center-tapped equalizing choke (PA-11B).

(Type numbers on chokes and transformers refer to UTC.)

ing from one to the other is accomplished by a double-pole double-throw switch. Separate gain controls are provided for the microphone and for the low-impedance line. A db meter permits constant observation of the speech level to the transmitter. The dual input is obtained through the use of a dual-primary transformer between the second and third stages. It will be noted that the coupling condenser to the output transformer is 1 μ d. rather than the usual 0.25 condenser shown in most connections of this type, and a word of explanation may not be amiss. If the reactance of the coupling condenser and the impedance of the primary of the transformer are considered as a voltage divider it will readily be seen that the frequency response at, say, 30 cycles can be considerably improved by increasing the coupling condenser from 0.25 to 1 μ d.

The audio tubes used in the remote amplifier are 6C6's. The first is high-impedance input, pentode connected, and is resistance-coupled to a second 6C6 triode-connected. The plate of the second 6C6 is shunt-fed into a dual-primary coupling transformer. The second (low-impedance) primary winding is fed from a 500-ohm "T" pad which in turn is connected to a 500-ohm line transformer. The 500-ohm line transformer permits inputs from 50-, 200- or 500-ohm lines. The third 6C6 is shunt-fed and works into a plate-to-line transformer.

CONSTRUCTION DETAILS

Looking at the front of the transmitter, the meters in the upper row, running from left to right, are as follows: Power amplifier filament, power amplifier grid, power amplifier plate and two r.f. antenna ammeters. In the row below are the oscillator plate, buffer plate, RK-20 plate and modulator plate.

The controls on the tuning panel are, reading from left to right, oscillator, buffer, driver, final p.a. grid, final p.a. plate, antenna, antenna. Below these controls are the controls for the 906 oscilloscope.

At the bottom of the panel is the Coto wheel control for the line voltage adjustment, by means of a seven-point switch connected to the auto-transformer.

Looking at the rear of the transmitter, mounted

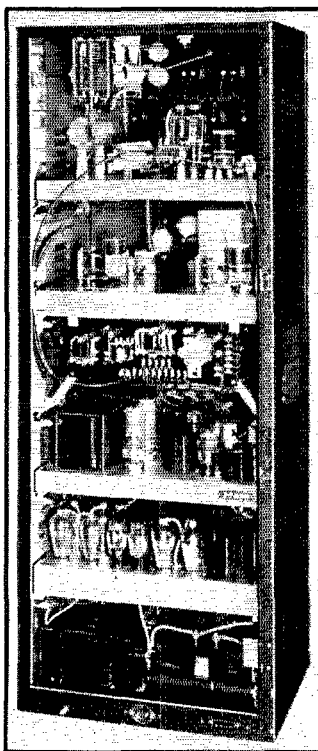

THE TRANSMITTER WITH THE REAR COVER REMOVED

Note the flexible cables running from the control panel to the various tuning condensers.

on the floor of the cabinet are the high voltage plate transformer, the 2-kw. auto-transformer, h.v. filter choke, condenser and bleeder. On the deck above are the filament transformers for the h.v. rectifier, and the 1000-volt rectifier, the bias supply and the oscilloscope supply.

Above the power supply deck at the rear of the chassis is the line-to-push-pull-grid transformer feeding the 2A3's, the 838 modulators and modulation transformers. Next to the driver and modulator and on the same deck is the low-voltage supply for the 2A3's and the RK-25 oscillator.

Above the modulator is the relay control panel containing overload, time-delay and starting relays. In front of the relay panel is the inclined tuning panel.

Directly above the relays is the deck containing the RK-25 oscillator, RK-25 buffer and RK-20 driver. It will be noted that the tank condensers on this deck are mounted on end for short leads to the coil sockets, which are elevated above the chassis. The RK-25 buffer is located behind the aluminum baffle seen at the right. All of

these stages are shunt fed to permit the tank condensers to be mounted directly on the chassis. The RK-20 tank coil has a link winding connecting with the two isolantite stand-offs at the right rear of the chassis.

The oscilloscope extends over the chassis between the oscillator and buffer stages and is supported from the front panel by means of four tapped rods and a square socket plate which has curved slots for rotation of the tube to obtain a horizontal image.

The top deck contains the push-pull 805's. The grid and plate tank condensers on this deck are mounted with the shafts to the rear, for connection to the tuning cables.

Directly above this plate tank is the low-pass antenna network, suspended from the top of the cabinet. The condenser shafts extend downward to connect with the isolantite flexible couplings on the cables, which run down through holes in the amplifier chassis. All inter-chassis wiring is by means of cable running behind the false side of the cabinet and terminating at numbered terminal blocks just below each chassis on either side.

Class-B Audio Design

A Simplified Method for Determining Correct Operating Conditions

By Earl I. Anderson,* W8UD

A REVIEW of the principles involved in Class-B operation seems to be in order because a knowledge of the fundamental principles is essential if proper operation is to be realized. This is particularly true if the voltages or tubes, or both, are not the ones specified in the operating data furnished with the transformers. The amateur is usually forced to use as much of the equipment at hand as possible when changes are made. He can not always, for example, purchase new power supplies if the ones at hand deliver voltages slightly higher or lower than the optimum values, nor does he wish to purchase new Class-B transformers when he replaces his modulator tubes with other types, if it is at all possible to use the ones he has.

On the other hand, it is extremely important to have the audio equipment working properly. Harmonic content or distortion must be kept at the absolute minimum. Every one wishes flat frequency response, yet frequency response from an amateur standpoint should be a secondary consideration to low harmonic content. A signal with low harmonic content, whether it has wide-range frequency response or not, will occupy only the minimum amount of territory necessary for voice communication, but a station with high harmonic content will spread and splash into adjacent channels and unnecessarily interfere with other signals. Even if an amateur did not care particularly how good his quality might be, he would owe it to other amateurs to keep his signal as *clean* as possible—and any improvement in this respect will necessarily improve the quality.

In speaking of distortion, we do not refer to frequency discrimination but to distortion of the wave form. Such distortion results in the generation of frequencies which are harmonics or multiples of the input frequency. Harmonics may be kept at a minimum if all of the tubes in the speech equipment are operating under proper conditions. They may originate in the low-level speech equipment as well as in the modulator stage, but improperly-operated modulators—and this applies to Class-A as well as Class-B—are chiefly responsible in so great a proportion of the cases that the factors involved are worthy of the consideration of every amateur.

TRANSFORMER OPERATION

Except for overmodulation, the commonest source of distortion is an overloaded modulator or

*Consulting Engineer, Taylor Tubes, Inc., Chicago, Ill.

one where the reflected load impedance is incorrect. Many amateurs seem to have a mistaken conception of the operation of an audio transformer. Audio transformers act exactly as do power transformers. The principles are exactly the same although, of course, the requirements are different. Perhaps this fact has been overlooked because power transformers are rated in terms of voltage and current while audio transformers are spoken of in terms of impedance or impedance ratios. It is sometimes assumed that if the secondary of an output transformer is marked 2500, 5000, 10,000 ohms or some other value, that the secondary is of that definite value regardless of any other considerations; and that if that secondary is terminated in a load of any other resistance or impedance, there will be a loss in power or fidelity. In other words, there will be a mismatch between secondary and load. Such is not the case. There is never any mismatch between secondary and load nor without any other qualifications is the impedance of the secondary the value marked on the secondary. If the primary is open and the secondary impedance measured, it should theoretically be infinity, and in any event will be many times the value marked on it. What the transformer manufacturer is trying to say is that with the specified modulator tubes, operating at the specified plate voltage and for the output specified, the secondary should be terminated in a load whose resistance or impedance is the value stamped on the secondary. If the modulator plate voltage is higher or lower, or if more or less output is required, the value probably would be different.

The purpose of a Class-B output transformer is to take the power developed by the modulators, which has a certain ratio of voltage to current, and change it to the ratio of voltage and current required at the secondary. If this ratio is correct it is said that the impedances are properly matched, because the ratios are expressed in terms of impedance. Under these conditions the power efficiency of the modulator will be the maximum obtainable with low distortion. If the ratios are not correct, one or more undesirable effects which will be discussed later will be evident.

The primary reflected load impedance depends upon the turns ratio of the transformer and the value of the impedance or resistance in which the secondary is terminated. If we had a transformer with the same number of turns on both primary

and secondary, the turns ratio would be 1 to 1 and the impedance ratio would also be 1 to 1. If we were to measure the impedance of either winding with the other winding open, the impedance would be some very high value; but if we connected a 5000-ohm resistor across the secondary and then measured the primary impedance we would find it to be 5000 ohms also. If the resistor across the secondary were changed to 2500 ohms, the primary impedance would also be 2500 ohms. If the transformer had twice as many turns on the secondary as on the primary, the turns ratio would be 2/1, or 2, and since the impedance ratio is the square of the turns ratio, the impedance ratio would be the square of 2, or 4. In this case, if we put a 5000-ohm resistor across the secondary and measured the primary impedance it would be one-fourth of 5000 or 1250 ohms. Similarly, if we put a 10,000-ohm resistor across the secondary, the primary impedance would be 2500 ohms. We are assuming that there are no losses in the transformer, a permissible assumption because in well-designed units the losses are small enough to be ignored.

THE CLASS-B PLATE CIRCUIT

The circuit of Fig. 1 is the circuit for all Class-B tubes. The components and operating potentials are varied to suit the tubes, but the circuit stays the same. The tubes are biased to

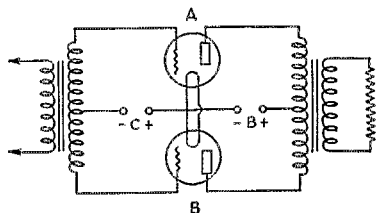

FIG. 1—THE ESSENTIAL CLASS-B AUDIO CIRCUIT

cutoff, or nearly so. So far as audio is concerned, the centers of both input and output transformers are at ground potential. If a.c. is applied to the primary of the input transformer, at any given moment the phase of the voltage applied to tube A will be opposite to that applied to tube B. For instance, when tube A is being driven positive, tube B is being biased further negative and being cut off entirely. On the other half of the cycle, tube B is driven positive and tube A is cut off entirely. From this it may be seen that only one tube works at a time and for this reason only one tube need be considered when making the necessary calculations.

So far as the tube is concerned the primary of the output transformer is a resistance, so the circuit for one tube might be drawn as shown in Fig. 2. A certain proportion of the supply voltage may be developed across R_p . It is impossible to develop all of the supply voltage across R_p be-

cause some voltage is required at the plate of the tube to attract enough electrons from the filament to permit the necessary plate current to flow. Also, the grid must never become positive with respect to the plate. In general, approximately 80 per cent of the applied voltage may be developed across R_p . The power developed will depend upon the current as well as the voltage and may be calculated by

$$\frac{(I_{p_{max}})^2 \times R}{2}$$

where $I_{p_{max}}$ = peak plate current to one tube.
 R^{max} = reflected load impedance to one tube (one-fourth plate-to-plate value)

We can also calculate according to the following expression, substituting E_{R_p} (peak developed voltage) for R

$$\frac{(I_{p_{max}}) \times (E_{R_p})}{2}$$

Let us assume that the plate-supply voltage is 1000 and that the drop across the tube is 200 volts. This would permit us to develop 800 volts peak across R_p . Let us also assume that the maximum recommended peak plate current is 0.5 ampere. $800/0.5 = 1600$ ohms reflected load impedance for one tube. The correct plate-to-plate load would be four times that value, or 6400 ohms. The audio output would be

$$\frac{0.5^2 \times 1600}{2} = 200 \text{ watts}$$

Now let us assume that the wrong value of load impedance had been used, say 2500 ohms per tube instead of 1600. With 800 volts across 2500 ohms, the peak plate current would be $800/2500$ or 0.320 amp.

$$\text{Power} = \frac{0.320^2 \times 2500}{2} = 128 \text{ watts audio output.}$$

From this it should be obvious that if the reflected load impedance is too high, the amount of power obtainable *without distortion* will be reduced.

On the other hand, suppose the reflected load impedance is lower than the optimum value of 1600 ohms—say 1200 ohms—and we require 200 watts of audio. Using the formula and solving for the unknown, we have

$$\frac{(I_{p_{max}})^2 \times 1200}{2} = 200 \text{ watts}$$

$$(I_{p_{max}})^2 = \frac{200}{600}$$

$$(I_{p_{max}})^2 = 0.333$$

$$I_{p_{max}} = 0.577 \text{ amp.}$$

With the correct value of reflected load impedance the peak plate current was only 0.5 amp., but now 0.577 amp. is necessary for the same output. As we mentioned previously, the recommended maximum peak plate current for this hypothetical tube was 0.5. The extra 77 ma. of peak plate current may introduce distortion and shorten tube life. In addition, the plate dissipation will be increased. In the previous case, with 800 volts developed across the plate load and a peak current of 0.5 amp., the plate dissipation at peak plate current would be 200×0.5 or 100 watts. In the second case, we are developing $0.577 \times 1200 = 692$ volts and the plate dissipation at peak plate current would be $308 \times 0.577 = 178$ watts. If plate dissipation is one of the limiting factors the tube will be badly overloaded.

THE IMPORTANCE OF IMPEDANCE MATCHING

This should answer the often-asked question of how important it is to match impedances. The situation may be summarized by saying that if the reflected load impedance is too high, the maximum power output without distortion will be reduced, although the efficiency will be good and the harmonic content low. If an attempt is made to obtain more power with excessive drive to the grids, the distortion will increase tremendously. The peak output, which is the important consideration in modulation, will not increase greatly but the average power may be increased considerably because of alteration of the wave form. For this reason, even though it may be impossible to obtain enough peak power to modulate 100 per cent, it may appear from the action of the meters that the capabilities of the modulators exceed 100 per cent modulation if no facilities are available for examining the waveform. The spurious frequencies due to the distortion will also make it appear at a receiving point as though the signal were overmodulated when, in fact, the voltage output from the modulator is insufficient to swing the carrier from zero to twice its unmodulated value—the requirement for complete modulation.

When the reflected load impedance is too low the situation is about as bad. The power efficiency of the modulator stage is reduced and the plate dissipation increased. If, in attempting to develop the necessary power and voltage, it is necessary to drive the plate current of the tube to a point where the filament emission is exceeded, the distortion will be high and tube life will be shortened. The effects of the distortion will be the same as if the reflected load impedance were too high, and it may or may not be possible to modulate 100 per cent.

In general, a variation of approximately 10 per cent from the optimum value is about the maximum permissible if best performance in all respects is to be obtained.

It is important to remember that the optimum value of reflected load impedance varies with the output desired and the applied voltage. For example, for an audio output of 200 watts from a pair of 203-A's with 1000 volts on the plates, optimum performance would be secured with a plate-to-plate load of 6900 ohms. If only 100 watts of audio were required, the optimum

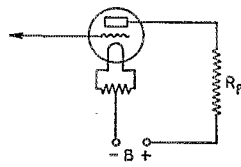

FIG. 2—EQUIVALENT CIRCUIT OF ONE CLASS-B TUBE

The load resistance, R_p , is one-fourth the plate-to-plate value.

plate-to-plate load would be twice that value or 13,800 ohms. If 200 watts were desired and the plate voltage were 1250, the optimum value of reflected load impedance would be 11,800 ohms. Because there are so many variables and because the consequences of improper operation are so serious in our crowded bands, it is extremely important that each amateur be able to make the necessary calculations. Fortunately these are easily made with the simplest of mathematics. Knowing the optimum value of reflected load impedance for the available plate voltage and desired output, as well as the impedance ratio of the output transformer, it becomes a matter of simple ratios. Assume the optimum value is 10,000 ohms and the transformer is marked 8000 ohms on the primary and 5000 on the secondary. The ratio would be

$$\begin{aligned} 10,000/X &= 8/5 \\ 8X &= 50,000 \\ X &= 6250 \end{aligned}$$

Thus the load resistance of the modulated amplifier should be 6250 ohms. The plate input to the modulated amplifier should be twice the audio output of the modulator.

DETERMINING OPERATING CONDITIONS

At least one tube manufacturer is publishing complete Class-B data for various outputs at various plate voltages for each type of tube, but common practice is to provide only one or possibly two ratings for each tube, usually the maximum values. In the former case, all of the figuring has been done except that of calculating the load impedance of the modulated amplifier from the impedance ratio of the transformer, as previously explained. In the latter case, we may make our own calculations. Let us use the hypothetical tube which we previously used in examples. The manufacturer's ratings probably would look like this:

(Continued on page 98)

How Would You Do It?

Designs for 50-Foot Antenna Masts—Announcing the Eighth Problem

DX conditions have been rather poor lately and the traffic net has suspended operation for the summer months. Nevertheless, Our Hero has not been exactly idle for he has been mulling over the dozens of antenna mast and tower designs sent in by his ham friends in response to his request in June *QST*. The job of selecting the prize winners was not easy since all of them indicated plenty of thought on the subject. After weighing all factors such as cost, strength, availability of material, appearance, ease of erection, novelty, etc., he finally emerged from the heap with the selections which follow.

First Prize Design

By Corliss B. Gardner, W1ALJ¹

THE mast used at W1ALJ should solve Our Hero's mast problem. It can be made forty to sixty feet high, requires only two back guys forming a tripod with the antenna and is cheap to construct.

The material required is as follows:

- 1—6 x 6 9 feet long
- 2—4 x 4 14 feet long
- 1—4 x 4 20 feet long
- 2 pieces 20 feet long, 1" thick, 3" at bottom end, tapered to 2" at top

- 1—Top piece 2 x 1 6 feet long.

- Lapping bolts:
- 4— $\frac{5}{8}$ " x 14"
 - 3— $\frac{1}{2}$ " x 7"
 - 3— $\frac{3}{8}$ " x 3 $\frac{1}{2}$ "

Reinforcement bolts to prevent splitting at ends of sticks:

- 6— $\frac{1}{2}$ " x 4 $\frac{1}{2}$ "
- 1— $\frac{1}{2}$ " x 7"
- 2— $\frac{1}{4}$ " x 3 $\frac{1}{2}$ "
- 3— $\frac{1}{4}$ " x 2 $\frac{1}{2}$ "

Each bolt requires two washers. Large square washers may be used on the lapping bolts and regular round washers on the reinforcement bolts. The bolts and washers should preferably be galvanized.

The cost of all material for this mast in this locality (Southern Rhode Island) was only about \$12.

EIGHT CONSTRUCTIONAL HINTS

1. Saw sides of bottom piece (6 x 6) to accommodate lapping of the two 4 x 4's. See Figs. 1 and 2.

NOTE.—Most so-called 4 x 4's are usually about 3 $\frac{5}{8}$ " square.

2. Shed the tops of all pieces to allow rain to run off.

3. Bore necessary bolt holes in all pieces.

4. Install the reinforcement

¹ 84 Church St., Peace Dale, R. I.

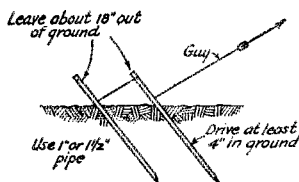

FIG. 3
METHOD OF DRIVING PIPE GUY ANCHORS FOR DURABILITY

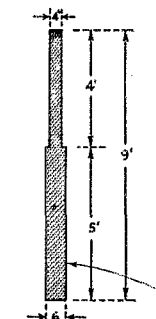

FIG. 2
DETAIL OF BASE PIECE
SCALE $\frac{1}{2}$ " = 1"

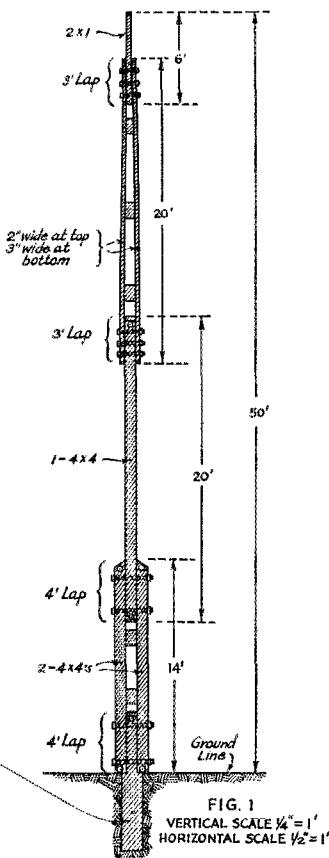

FIG. 1
VERTICAL SCALE $\frac{1}{4}$ " = 1'
HORIZONTAL SCALE $\frac{1}{2}$ " = 1'

A 50-FOOTER OF HUSKY CONSTRUCTION. ONLY TWO GUY WIRES AT THE TOP ARE REQUIRED.

bolts with washers in ends of all pieces where necessary and tighten.

5. Lay all pieces on level ground in mast formation and insert bolts. Tighten all bolts except those for lapping the first two parallel 4 x 4's with the second 4 x 4.

6. Cut and fit the intermediate reinforcement pieces used in the two parallel sections and nail them permanently in place. They should be about one foot long.

7. Get three or four soap boxes for horses and paint mast if you desire. Light gray makes a fine-looking mast.

8. Use at least 1/2" rope for raising any antenna and install a good pulley on top stick.

Guying of this type of mast is neither complicated nor costly. No. 14 or 12 steel wire will suffice for an ordinary single wire antenna. Small egg type strain insulators are best for breakers due to lapping of guy wire holes. They should be spaced about 12 feet.

As previously mentioned, only two back guys are necessary, each of these spaced 120 degrees from the antenna.

There are numerous methods of anchoring the guys but the most common are trees, fences and pipes driven in the ground. The latter method is shown in Fig. 3. The guy anchors should be installed at least 30 feet from the base of the mast.

INSTALLATION

Dig hole 5 feet deep for 6 x 6. This piece may be set in cement or reinforced by filling hole with rocks and tamping dirt around them. Use level to make sure base piece is vertical. Raise first two parallel 4 x 4's, and bolt in place to base piece. Raise remaining 40-foot section to vertical position beside the parallel 4 x 4's. It is not heavy and one man can easily accomplish this. While a brother ham holds the 40-foot section in place, climb a stepladder and tie a piece of rugged rope or wire loosely around the whole assembly about 2 feet down from the top of the parallel 4 x 4's. Hold this in place with a staple driven into one of the parallel 4 x 4's. This will serve as a safety guide while raising the 40-foot section vertically. Two men take one guy each and walk in opposite directions from base of pole to a distance of about 40 feet. Get a good hold under bottom of 40-foot section and raise vertically. Men on end of guys should allow plenty of freedom and yet not allow top to sway more than 12 inches or so. When bottom of this section reaches your waist, start walking up stepladder. If you are rugged, you can handle mast with one hand and hang on to stepladder with the other. However, if you are not rugged, someone should help you during this operation. When 40-foot section reaches the proper height, slide its base between the 4 x 4's and insert the two bolts for this lap. Tighten nuts and the mast is complete.

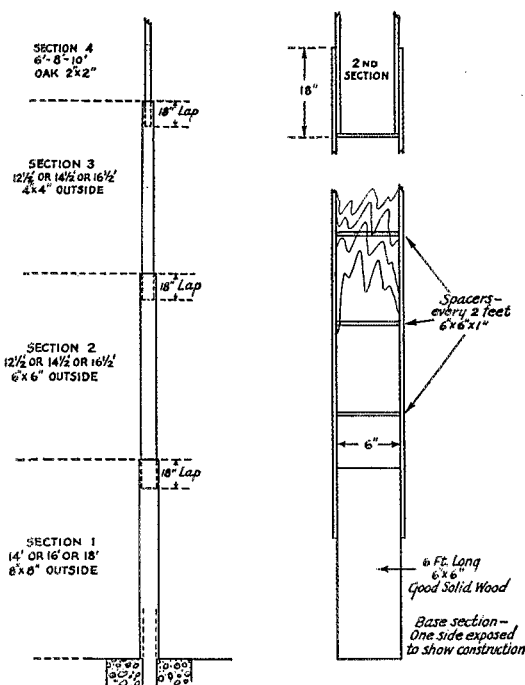

FIG. 4—LIGHT BUT STRONG. A NOVEL MAST OF HOLLOW CONSTRUCTION

Second Prize Design

By Nathaniel C. Smith, W2GZU-W9UJ²

THE writer believes that the attached drawings and description given below are the exact answer to a ham's wish for an ideal antenna stick. The pole was erected in 1921 when the writer was ADM of Illinois and is located in Hoopeston, Ill., where up to two years ago it was still standing, straight and true, though somewhat in need of paint. The cost of materials for the mast, white lead and guy wire is just about \$10. It was sold for \$5 when I left Hoopeston in 1924 and is still standing in 1937, to the best of my knowledge, in the yard of the ham who purchased it. Its appearance and life have been so remarkable that I believe I built better than I realized, so I feel that I am really passing along a good and worthwhile suggestion.

The principle of the thing is to create a square hollow pole, held together in the fashion of bamboo growth; that is, with a bracing and strengthening section spaced about every 2 feet. The essential details are shown in Fig. 4.

The lower section of the mast is naturally the larger. Its foundation is a good solid 6 x 6 timber about 6 feet long. The next step is to make a section about 14 or 16 or 18 feet long, depending

² 3001 Henry Hudson Parkway, New York City.

upon the availability of the lumber which should be good, smooth finish, hard pine, cypress or spruce, depending upon the locality. Needless to say, good grain free from knots is desirable. Three pieces (assuming that 18-foot stock is available) are laid out. There will be two sides 6" wide by 18' long of $\frac{3}{4}$ " or $\frac{1}{8}$ " stock, and the third will overlap on the edges so that it will be 8" wide x 18' x $\frac{3}{4}$ " or $\frac{1}{8}$ ". Insert the 6 x 6 about 2' into the U formed by the three pieces above mentioned. After lining up so that all edges are flush, commence to fasten together with nails, or preferably iron screws with flat heads, not forgetting to paint thoroughly every edge with a nice thick mixture of white lead and linseed oil. Having completed this step we should have a "U" section of mast 8" x 6" x 18' with a 4' section of 6 x 6 as a base, which will be later embedded in concrete when we are finally erecting the mast. The next operation is to put in the braces every 2 feet. These are 6" x 6" x 1" thick. These should be put in with white lead between wood surfaces and thoroughly fastened with screws or finishing nails. At the open end of the "U" we leave 18" for the insertion of the next section of the mast which telescopes into the base section. Give the inside a thorough coat of white lead and linseed oil about the consistency of glue and let dry for a week or so. The cover for this section of the "U" is another 8" x 18' x $\frac{3}{4}$ " which is screwed down after the second coat of white lead and linseed oil is dry. Any irregularities in the lumber and joints should be smoothed down with a plane.

The second and third sections of the mast are constructed in a fashion similar to that of the base, except that they are progressively smaller

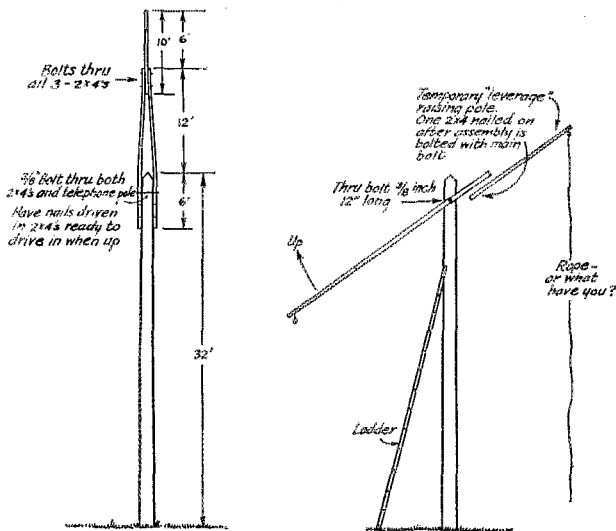

FIG. 5—THIS TYPE MAY BE CARRIED TO A HEIGHT OF FIFTY FEET OR MORE. NO GUY WIRES ARE REQUIRED

and that there is no need for a solid inner base section in the upper sections of the mast. We can see that the second section should have outside dimensions of 6" x 6" to telescope inside the base section and that the third section will be 4" x 4" to telescope into the second and that the top sec-

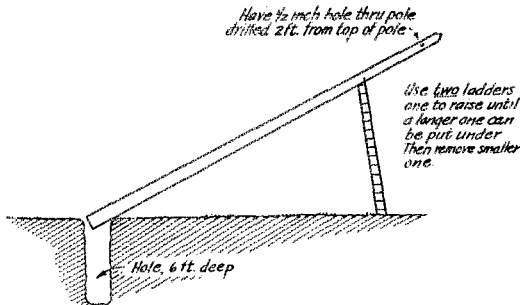

FIG. 6—A PAIR OF LADDERS IS HELPFUL IN RAISING THE LOWER SECTION

tion is a solid 2" x 2" of say 12 to 20 feet. Our sky hook will be easy to erect and in the vicinity of 50 to 60 feet, depending upon the length of lumber available.

If a 50-footer is all that is desired, an attempt should be made to obtain 18-foot lumber for all sections. The third section should be capped or plugged instead of being filled with a 2" x 2" x 20' timber (hardwood imperative). For three sections, which just about approach 50' altitude, the mast will be solid as a telephone pole and can be climbed with safety even if you are a 200-pounder. With the top section of 2" x 2", it can be climbed by lighter men, but it is slightly "whippy" because only four guys are used, one in each of the points of the compass to take the strain off the antenna.

Let me add that the care in making the joints and keeping everything square and shipshape will pay when the sections are bolted together. Also it is very important to put white lead between the surfaces wherever wood joins wood. On top of this caution one should give it at least two coats of white lead and linseed oil. It will take a good deal of white lead but it will be money well spent.

Erection of this mast is child's play for a fellow who can "tote" a man's share. About three huskies are all that are needed for pure "pusha-pushu" under a pair of 2 x 4's bolted together like a scissors. A hole is first dug for the base of the mast about 4' deep and with enough space around it to pour some good "grout" concrete. In the direction in

Problem No. 8

OUR Hero has another problem which has been bothering him for some time. Things came to a head around three o'clock the other morning in the middle of a QSO with a VK. The YF suddenly appeared on the scene with fire in her eye and demanded the cessation of "that awful racket." The "awful racket" referred to was the incessant thumping and clacking of the homemade magnetic antenna changeover switch. Our Hero believes there should be a way to eliminate this noise either by proper switch design or by some satisfactory mounting. He would like suggestions with complete details.

The usual monthly prizes of \$5 and \$2.50 worth of A.R.R.L. station supplies for first and second selections are offered.

which the mast lies, a slanting runway about the width of the mast and as deep as the bottom of the pit where it is finally to rest should be dug. The 6 x 6 butt is eased down this runway to the bottom of the pit which throws the top of the mast to about a 15 to 20 degree angle. Then the three huskies put the 2 x 4 scissors under the second section of the mast and "Heave ho! my hearties." The hardest part about building this mast is waiting for the white lead and linseed to dry. After two coats inside and out and roundabout, you will find it in your coffee and your pajamas and other unexpected places but 15 years later it will have been about forgotten.

The complete list of material required is given below:

1st Section

- 1—6" x 6" x 6'
- 2—6" x 18' x $\frac{7}{8}$ "
- 2—8" x 18' x $\frac{7}{8}$ "
- 7—Spacers 6" x 6" x 1"

2nd Section

- 2—4" x 18' x $\frac{7}{8}$ "
- 2—6" x 18' x $\frac{7}{8}$ "
- 8—Spacers 4" x 4" x 1"

3rd Section

- 2—2" x 18" x $\frac{7}{8}$ "
- 2—4" x 18" x $\frac{7}{8}$ "
- 8—Spacers 2" x 2" x 1"

Top Section

- 1—2" x 2" x 20'—oak
- 1—Pulley (Brass or bronze)
- 1—(Necessary length) Manilla rope
- 4—Guys (necessary length) No. 8 iron galvanized wire
- Strain insulators

Honorable Mention

By C. Falstrom, W9LM³

FOR Problem No. 6 I will describe the mast in use here at W9LM. It was put up at a cost of no more than \$8. Only four persons were needed to put it up and no guy wires were used. It has stood four years through some strong winds, too. The drawings of Fig. 5 will help to make the details clear.

A used telephone pole was purchased and delivered for \$5. That wasn't a special discount either. It was 38 feet long. A hole 6 feet deep was dug for it. This left about 32 feet above ground. About 2 feet from the top of the pole a half-inch hole was bored. The raising was done by hand until a ladder could be placed under it. Two ladders were used. After the pole was raised with a short ladder (about 12 foot long), another one about 20 feet was used to raise it up all the way.

The top section was assembled on the ground. Three 2 x 4's were needed, two 18 feet long and one 10 feet long. The 10-foot section was placed between the two others and bolted in place so that the total length was 24 feet. The assembly also required a half-inch hole to receive the main bolt which is $\frac{3}{8}$ -inch diameter about 12 to 14 inches long. This half-inch hole was drilled about 5 feet from the ends of the two long pieces. The long pieces were spread so that the 2 x 4's would go on each side of the telephone pole, and the long bolt inserted. Three or four nails were driven in one side of one long length to nail it on the telephone pole when it is up straight. In order to obtain leverage to swing this top part into an upright position, a temporary piece of 2 x 4 was nailed to the other long piece on one side. A rope was fastened on the end so that someone on the ground could swing the whole top section up in the air. This temporary raising apparatus should be in good condition to prevent the thing from coming back down with a bang.

³ 1916 North Allis St., Kansas City, Kans.

O. H. wishes to thank the following for submitting designs: W1FTB, KCQ; 2BEZ, JSL, KAQ; 5WN; 7AZX; 8OA, SOMM, 8OKC; 9ASV, VTH, WLE, YWX; VE3QB; C. S. Fleming, Wm. Roberts, H. N. Schmidt.

Strays

Comes now a letter from Charles E. Bates, Jr., W6JWX, to say that he is not among Silent Keys as reported in our December issue. Naturally we regret the occurrence, and, having expressed ourselves on this subject on one or two previous occasions, only can add that while the business of reporting a live ham as having passed on may seem humorous to mentalities of four years, to normal people there's nothing particularly funny about it.

HINTS and KINKS for the Experimenter



An Inexpensive Time Delay Relay

By Wilbert B. Smith *

TIME delay relays, though almost a necessity in the up-to-date transmitter, are often avoided because of the cost. However, an ordinary power-remote control relay can be made to do the trick by the addition of a flasher and lamp bulb. The flasher may be of the small disc variety which may be obtained at any electrical store.

Fig. 1 shows one circuit arrangement using a double-pole double-throw relay. Initially the lamp and flasher are in series across the 110-volt line and the relay coil is across the flasher. When the

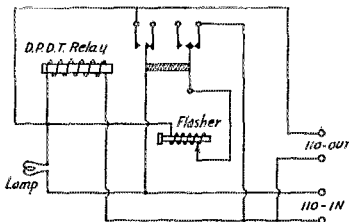

FIG. 1—TIME-DELAY RELAY USING POWER RELAY AND FLASHER

flasher heats up sufficiently to open, the relay coil is energized, whereupon the lamp and flasher are disconnected, and the relay coil together with the load are connected directly across the line. It should be noted that this relay should be of the

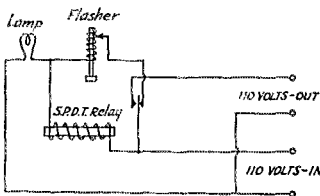

FIG. 2—THIS TIME-DELAY CIRCUIT MAY BE USED WITH A S.P.D.T. RELAY OPERATING ON LOW CURRENT

quick-acting type, with a fairly heavy armature, otherwise it will not hold in what the flasher opens.

Should the relay at hand not prove suitable for use as in Fig. 1, the circuit shown in Fig. 2 may be used. Here the relay is always connected

* Chief Engineer, CJOR, Vancouver, B. C.

in series with the lamp, but is shorted out by the flasher until the latter warms up sufficiently to open. Having the relay in series with the lamp is not a material disadvantage, providing it receives sufficient energy for correct operation. If the relay draws considerable current a larger bulb and flasher may be used.

For most purposes a flasher suitable for use with a 60-watt lamp will give good results, the time lag, of course, depending on the bulb used and any possible adjustment on the flasher itself. Time lags longer than about 20 seconds are inclined to be rather unstable, hence this type of relay is not altogether suitable for such service.

A suggested arrangement is to mount the lamp bulb and the flasher in a twin plug fuse receptacle, with a plug fuse to complete the circuit through the flasher. A refinement would be to substitute a resistor for the lamp bulb and a special mount for the flasher.

Break-In Operation with a Dynamotor

By Robert E. Valgren, W9ALO

FOR those fortunate enough to have a.c. available, break-in is so simple there is no excuse, it seems, for not using it. But for the ham who must depend on a dynamotor, or a motor-generator set, it may not be such a simple matter. The dynamotor at this station made so much QRN that even an S9 signal was copied with difficulty. After making a number of inquiries as to possible remedies, I was none the wiser and about to give up. R.f. chokes and condensers up to 20 μ f. across the brushes did not improve matters much, if at all. The machine is put up in an iron casting so shielding it further did not hold much promise.

However, I decided to try something. With the aid of the soldering iron, a box with a tight-fitting cover was made from galvanized-iron sheet. It was made with two compartments. In one, the dynamotor was mounted on heavy felt padding to absorb vibration and thus eliminate much of the QRN coming through the air, and also to insulate the machine completely from the sheet-iron box. That may be of importance. Two 2- μ f. condensers were connected in series across the primary, or motor, brushes. The center tap, or the connection between the condensers, was

grounded to the dynamotor frame. Lead-covered cable was used to connect the primary to the storage battery. The sheath of this cable makes contact with nothing except the metal box.

In the other compartment was placed the starting relay, a Ford generator cut-out, and three chokes, one in series with the lead to the starting relay, and one in each secondary or high-voltage lead. The chokes are "shuttle" type, and are wound with about 325 turns of No. 23 d.c.c. They are separated as far as possible in the box and the center one is wound in the opposite direction from the others. The dynamotor is a General Electric, 24/750-volt machine and has a 1- μ d. condenser in the base to filter the high voltage. Using crystal control, T9 reports

effective. By habit I connect the inside terminal to the output or cold side of the circuit. Sometimes chokes are more effective if individually shielded in small tin boxes such as Kester solder boxes. Different size chokes may be tried. Grounding the metal box may help, but in my experience "floating" shields are more effective as a rule.

— . . . —

Measuring R.F. Power with an Exposure Meter

IN CALIBRATING a series of lamps for measuring r.f. power by means of a Weston exposure meter, I ran across the following kink which may be useful to others.

Choosing the more open portion of the exposure meter scale, and using only that portion between 10 and 200, the following is the method:

(1) Connect the lamp or lamps of the desired power rating to the lighting circuit. Assume that the lamps are consuming their rated watts.

(2) Mount the exposure meter at such a distance that meter reads 200, and fasten it firmly in place.

(3) Disconnect from lighting power and send radio power into lamps.

(4) The curve of Fig. 3 is a calibration of percentage of total watts vs. meter reading, and holds within a permissible 3 per cent or 5 per cent accuracy for all lamp sizes.

—G. M. Hannah, W3AFR

— . . . —

Keying a 53

IN RECENT experiments here I have come across an excellent method of break-in keying on the 53 oscillator-doubler. With this system not only are chirps at a minimum, but clicks are entirely absent. It was found to work satisfactorily with AT-, V- and Y-cut crystals.

At the first attempt to use this circuit, keying between crystal and ground, an annoying hiss was heard over the band, and chirps and clicks were pronounced. The clicks were suppressed by insertion of a 0.005- μ d. condenser, as shown in Fig. 4. This value is fairly critical, as less will not suppress the clicks, and more causes the condenser to unload its charge at intervals of about 10 seconds. This also reduced the chirp, and when a low-resistance bleeder was installed in the power supply, the chirp had completely disappeared. I had never accomplished this before in keying a

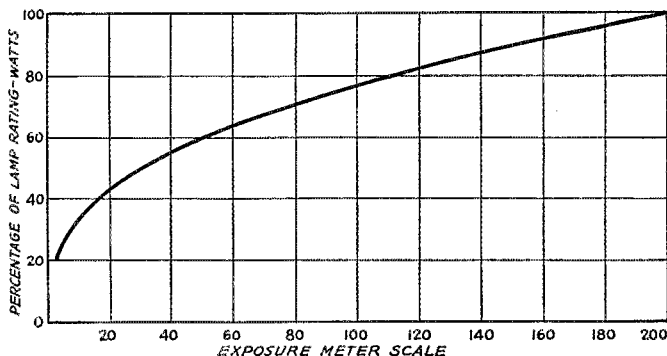

Set Exposure Meter fixed distance from MAZDA lamp of desired wattage and fasten at distance giving 200 when lamp is connected to 115V. 60~

FIG. 3—CALIBRATION CURVE SHOWING PERCENTAGE OF NORMAL INPUT POWER VS. READING ON WESTON EXPOSURE METER FOR THE CONDITIONS DISCUSSED IN THE TEXT

are received on all bands even without the filter but it helps to minimize sparking at the brushes. With the load off, the H.V. QRN is of little consequence. The entire output is keyed with another generator cut-out relay so there is no load on the machine when the key is up. The advantages of the idea are "break-in" on any frequency, less drain on the storage battery and greater output due to greater speed of the armature because of the "fly-wheel" effect. This would, perhaps, not be advisable unless the rig is crystal controlled, although dynamotors have very good regulation unless greatly overloaded.

After the cover was put on the box, it was a pleasant surprise to find the generator hash had cleared up enough so all signals except the very weakest could be copied with the machine running, making c.w. break-in and 'phone push-to-talk operation possible. The precautions I took may not be necessary in all cases, but a few additional suggestions may help more stubborn ones. A large choke in each primary lead, wound with No. 10 to No. 14 enameled wire, may be useful. Shuttle-type chokes are very compact but ef-

53. However, one more problem presented itself—the hiss made this system quite useless. Finally it was completely stopped by insertion of an r.f. choke in series with the key, on the side next to

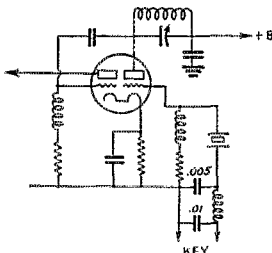

FIG. 4—CLICKLESS AND CHIRPLESS KEYING CIRCUIT FOR A 53 OSCILLATOR-DOUBLER

the crystal, and a 0.01- μ fd. condenser across that on the key side. This value is not critical, and can be varied to give a bong to the note, at the discretion of the amateur.

—Edward J. Meehan, W3FPW

Grid-Modulator Coupling

THE method shown in Fig. 5 for coupling a modulator to a final stage for grid modulation may prove of interest to the gang. No special coupling transformer is required and the parts will be found in the always present junk box.

I am using this scheme here to modulate a 211 on 80 meters and find it works quite satisfacto-

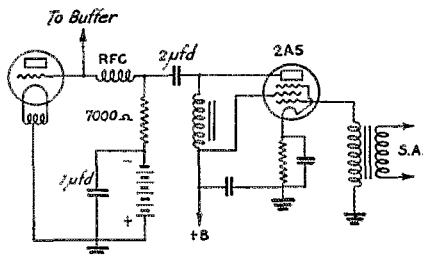

FIG. 5—RESISTANCE-IMPEDANCE COUPLING FOR THE GRID-BIAS MODULATED AMPLIFIER

riety. A single-button mike works into a 56 stage through the usual transformer and then into a 2A5. The plate current to the 2A5 is fed through an ordinary 30-henry 100-ma. choke. The plate side of this choke connects to the grid of the final through a 2- or 4- μ fd. condenser. A resistance of about 7000 ohms is inserted in the grid-bias lead and by-passed around the bias batteries with a 1 μ fd. (or larger) condenser. The modulator is thus working across a load approximately equal to its rated plate load. With a just-perceptible movement in the final milliammeter the quality and output are quite satisfactory.

—R. L. Bunt, VE3MX

EDITOR'S NOTE.—Although it is theoretically undesirable to introduce appreciable resistance into the grid circuit with grid-bias modulation, because of the change in effective bias resulting from the change in rectified grid current with voice excitation, quite satisfactory results can be secured provided the change in grid current under normal operating conditions is not large. Any distortion introduced from this cause can largely be eliminated by shunting the 7000-ohm resistor by a high-impedance choke or transformer winding having a d.c. resistance of not more than a few hundred ohms.

West Gulf Division Convention

Houston, Texas, August 20th-21st

THE Hotel Rice will be the center of attraction for the 1937 official division convention to be held August 20th and 21st, at Houston, Texas, under the auspices of the Houston Amateur Radio Club. From the very beginning Hams will be kept on the go, because the motto of this convention is "Entertainment." Of course other things are on the program. Come and see the big doings for hams, YLs and XYLs. Publicity has already been released but watch for more, and meanwhile if you want more information, write to I. P. Holland, Chairman, Box 707, Houston, Texas.

New Vibrator-Type Plate Supplies for Storage-Battery Operation

WITH growing interest in portable and emergency equipment which is independent of an a.c. source of power, there has been a definite need for a compact and relatively inexpensive plate supply capable of operating from a 6-volt storage battery; one which would give reasonably high output for the operation of a transmitter having sufficient power for practical communication. This need has now been met through the introduction of a new vibrator-type unit which is capable of supplying somewhat more than 30 watts for the transmitting-tube plates. The unit is known as the "Vibrapack," and is made in four types, two of which have a maximum output of approximately 200 volts at 100 milliamperes, the others 300 volts at 100 milliamperes. In all types, the output is adjustable in four 25-volt steps.

The Vibrapack carrying the type number VP-552 is of chief interest to amateurs looking for a portable transmitter power supply. It is of the self-rectifying type, no rectifier tube being required, and has a maximum output of slightly over 300 volts at 100 ma., using a condenser-input filter with an 8- μ fd. input condenser. The Vibrapack contains the interrupter-rectifier, power

(Continued on page 82)

• I. A. R. U. NEWS •

Devoted to the interests and activities of the

INTERNATIONAL AMATEUR RADIO UNION

Headquarters Society: THE AMERICAN RADIO RELAY LEAGUE, West Hartford, Conn.

MEMBER SOCIETIES

American Radio Relay League
Associazione Radiotecnica Italiana
Canadian Section I.A.R.U.
Československí Amatérský Vysílací
Duitscher Amateur Sende-und-Empfangs
Dienst
Experimenterende Danske Radioamatører
Irish Radio Transmitters Society
日本アマチュア無線聯盟 Japan
Liga Colombiana de Radio Aficionados
Liga Mexicana de Radio Experimentadores

Magyar Rövidhullámú Amatőrök Országos
Egyesülete
Nederlandsche Vereeniging voor Interna-
tionaal Radioamateurisme
Nederlandsch-Indische Vereeniging voor
Internationaal Radioamateurisme
Newfoundland Amateur Radio Association
New Zealand Association of Radio Trans-
mitters
Norsk Radio Reize Liga
Oesterreichischer Versuchssenderverband
Polski Związek Krotkofalowcow

Radio Club Venezolano
Radio Society of Great Britain
Rede dos Emissores Portugueses
Reseau Belge
Reseau des Emetteurs Francais
South African Radio Relay League
Suomen Radioamatööriliitto r.y.
Sveriges Sandareamatörer
Unión de Radioemisoros Españoles
Union Schweiz Kurzwellen Amateur
Wireless Institute of Australia

Conducted by Byron Goodman

Calendar:

Although, at the time of writing, the June, 1937, issue of the I.A.R.U. Calendar has not yet been fully completed, it has enough of interest to the amateurs at large to be reviewed briefly. As you know, the Calendar is the bi-annual medium through which Union business is transacted and proposals formulated.

Proposal No. 28, on the question of sub-dividing the 7- and 14-Mc. bands (reproduced in the July issue of *QST*) was lost by a very close vote. The proposal aroused the widest conceivable differences of opinion, and the reasons for voting against it were in many cases mutually conflicting. This is due partly, of course, to the varying conditions and regulations in the member-countries. However, the response of the societies indicates that the subject is well worthy of discussion and the last of it has certainly not yet been heard.

The question of amendment of proposals after publication in the Calendar but before voting, Proposal No. 29, received but one dissenting vote, and was therefore adopted. This sets up the machinery for speeding up action in Union affairs.

The working code of "Miscellaneous Rules" was unanimously adopted, and a permanent appendix has been added to the Constitution incorporating those permanent policies other than constitutional amendments that have been adopted by the Union from time to time.

The Newfoundland Amateur Radio Association was unanimously admitted to the Union, making the total membership now twenty-nine. Speaking on behalf of the other member-societies, a number of whom expressed sentiments of congratulation, the Headquarters extends this new

member a cordial welcome and hearty good wishes.

The recent enactment of a rule requiring that member-societies refrain from forwarding QSL cards to non-member societies in countries where there exists a regular member-society of the Union results in a condition whereby, if a society refuses to forward cards to non-members, amateurs in a given country may have no way of receiving cards. There would seem to be a definite obligation on the part of a society which accepts the QSL-handling responsibility for a country to handle all cards for amateurs within that country, irrespective of membership. At the same time, since the non-member does not aid in supporting the society, it is entirely reasonable to insist that he pay for such service. In view of this situation, the R.S.G.B. has proposed a modification of the Rule which would incorporate the above considerations, presumably through some machinery whereby non-members would keep stamped, self-addressed envelopes on file with the national QSL Bureau, or be able to collect their cards in person.

Two new societies have been proposed for membership, the *Reseau Luxembourgeois des Amateurs D'Ondes Courtes* and the Experimental Radio Society of Egypt. The *Reseau Belge*, in which are grouped the French-speaking Belgian amateurs, has combined with the Flemish-speaking Belgian organization, the *Vlaamsche Radio Bond*, to form the *Federation des Emetteurs Belges*, and now requests that the F.E.B. be recognized as the member-society of the Union for Belgium.

The W.I.A. proposes that the major societies hold not more than six international DX contests

a year, with the smaller societies cooperating to conduct smaller biennial contests. Worked in conjunction with the Contest Calendar to avoid conflict, it should result in an eventual system that will space the contests evenly throughout the year.

A list of the boundaries of the territory under the jurisdiction of each society was given, to facilitate the determination of qualifications for the issuance of WAC certificates, and an "N" system for designating types of notes when giving signal reports was suggested by the D.A.S.D.

56-Mc. Tests:

The Lausanne section of the U.S.K.A. will conduct 56-Mc. tests on August 14th-15th from the summit of Mont-Tendre at Jura, and asks that all interested amateurs listen for the signals. The call HB1AQ (HB1 is the new portable designation) will be used and, starting at 1800 GT, on August 14th modulated transmissions will be sent for 15 minutes, followed by a 15-minute listening period. The last half hour of each hour will be used for two-way work. This schedule will be maintained until 1600 GT on August 15th.

HB1AQ hopes that a number of amateurs will listen for the transmissions; a QSL card will be sent to all stations heard or worked.

General:

G2LK reports that the Manchester gang won the RSGB National Field Day held during June. . . . OZ7EU won the hidden transmitter hunt at an outing at Odense. About 30 amateurs participated. . . . A clipping from a London newspaper discloses that the English amateurs are becoming emergency-conscious, after a flood at Fen, where two amateurs served as a means of communication between two isolated points. The plan calls for amateur equipment capable of operation independently of the commercial power lines. . . . W2LG, visiting in England, is convinced that the United States is a paradise as far as easily-accessible and inexpensive radio gear goes. Lamb and Stadler tell the same story.

WAC:

The following WAC certificates were issued during 1936:

Madeline MacKenzie, VK4YL; W. G. Huppertz, VK5GW; A. C. J. Pritchard, VK3CP; D. H. B. Duff, VK2EO; A. Guildford, VK4AP; Alberto Kirschner, EA4BF; Arthur David-Andersen, LA4N; Knut Iversen, LA4P; R. F. Galea, ZB1E; P. Legrand, ON4FX; Juan Lobo y Lobo, X2N; J. J. Cortes das Dores, CT1DT; Reeve O. Strock, W2GTZ; Joseph P. Jatis, W9CYT; Elmer Koehler, W9BEU; Stanley Belliveau, W7AYO; Carlos W. Jacklin, W6LXJ; James N. McCaskill, W4CDE; Gordon Jones, W4COO; Clyde Schoenfeld, Jr., W6KNH; Arthur Melanson, VE1DO; Madison B. Donegan, W6IF; Roger F. Hathaway, W1RY; Franklin W. Gorham, W6LNU; Cameron Pierce, W6HJT; Thomas A. McCann, W3FRE; Rolf Lindenhayn, Jr., W2BHW; John

W. Clarke, W1DET; Paul Veiry, F3DN; A. Eburne, G2DK; W. R. McLaughlin, VK2ML; R. W. Ware, VK3DP; H. Windelband, D4HER; Juro Nagao, J2LL; Arthur L. Thorley, G2NQ; Gustaf Linde, SM7WS; Jean Defrenne, ON4MD; Don Joaquin Portela Rodrigues, EA7AV; Thomas B. Stacey, K6AUQ; Andrew P. Schmidt, W2GYM; Ned L. Jacoby, W8KPB; J. Warren Donahue, W1JCE; Dean Riggs, W6JM; Frank H. Speir, KA1AN; George R. Caron, W1EBD; Robert Frey, W6IES; C. H. Krueger, W4BCR; C. Bayard Snack, Jr., W3AYS; G. Ross Kent, ZT6R; Jules T. Steiger, W1BGY; Clement M. Goo On, W3EVT; Russell G. Benedict, W6GNZ; Leigh Norton, W6CEM; Yardley Beers, W3AWH; Katashi Nose, K6CGK; Dr. H. J. Hocking, VE5FG; Elwin Troutman, W6IQY; Randolph H. Ogg, W7AOD; Anatol Poruznik, YR5AP; John Macnak, W9RGB; Charles M. Waff, Jr., W3UVA; Donald E. Chesser, W8KVV; Joseph P. Jessup, W2GVZ; Fred Neal, VE3QH; John M. Wells, W1ZD; James C. Lisk, W8EQ; John S. Fogg, Jr., W1DUJ; John P. Bloomer, W5BEQ; Paul J. Moore, W9MV; William Adrian Robinson, W2EYY; William L. Reed, W3FKK; Charles W. Nicholson, W1BAU; James L. Young, Jr., W5DLJ; Norman Ward, W9EWU; Fred Reid, Jr., W7EJD; James J. Fitzgerald, W1FLH; H. J. Seigel, W3EDP; Carl F. Mueller, W2GIZ; E. M. Austin, VK2KZ; R. T. Manuel, VK5RT; H. N. Bowman, VK5FM; E. N. Arnold, VK2OJ; K. R. Rankin, VK3KR (phone); R. Y. Parry, G5XV; Henri Vander Wielen, ON4VW; Robert Pettitier, F8VO; B. Turner, G6ZT; H. N. D. Bailey, G5BP; Dr. Harald Dickertmann, D4IRG; Wilhelm Bender, D4OQT; Rudolf Maushart, D4BQO; Vladimir Kott, OK1FF; Bohuslav Finke, OK1FK; Rudolf Stuber, HB9T; S. E. Smith, G2LA; Kurt Schlupp, D4CEF; W. H. Potter, ZL1CC; J. A. Stevens, ZL2QM; K. Akasawa, J3EN; J. N. Smith, GI5QX; Birger Larsen, LA2B; B. S. Watson, ZT6W; A. E. Way, ZT6S; T. A. Laxton, ZU6L; H. L. Howes, ZS1AL; C. D. S. Underwood, G5UD; Don Julio Anglada, EA3CY; Cletus M. Dunn, W9DIT; William M. Atkins, W9TJ; R. A. Jubb, ZELJN; Paul Hallingby, Jr., W6JKE; Mrs. Evelyn S. Sanford, W4DAI; E. F. Sanford, W4DHM; Eric H. Reilly, VK4ER; Charles W. Rogers, W2AIW; Hubert Rieck, Jr., W9OVU; Richard M. Groves, W5EKV; Jack T. Woodruff, W9PK; Jack Pimlott, W8CGK; Paul B. Lovegren, W9AFN; Fernand Causse, W3EOI; Cecil M. Phillips, W7AYJ; J. D. Ryder, W8DQZ; Richard V. Vockroth, W8AYD; Raymond D. Stiles, VE2EW; V. C. Sahnov, W7AVV; James S. Moore, W9AZP; Allan Chesworth, VE4JV; Edward D. Schwartz, W6GPU; James Headrick, W6CPB; Ronald W. Moran, W3EJO; Ralph B. Ladd, W4CK; Robert C. Graham, W8LUQ; Robert M. Haskins, W4DRZ; Rod Meaney, W8JTW; Burton L. Fielding, W9SOT; Harry Whiting and Owen E. Coyle, W2FCX; Frederic C. Shidel, W9CIU; Samuel E. Johnson, W2FBS; S. J. Bayne, W4AAQ; Guy Grossin, F8RJ (phone); Guy Grossin, F8RJ; Harry Loretz, Jr., W6GWW; H. W. Green, ZT6Y (phone); T. J. Bradford, ZT6AK; Mr. Dirnagel, D4TKP; Senor Don Alfredo Guito Paig, EA3DP; G. A. Chapman, G2IC; Gerhard Hansen, OZ7G; Ramon Alonso Estevanes, EA1AZ; Gabriel Bracons, EA3CI; W. H. Robertson, G6WR; V de Robillard, VQ8AF; Tadashi Matsubara, J4CF; Dr. Ryozo Nagasaki, J8CD; Herbert Alfke, D4XCG; S. E. Martingell G2MV; W. L. Harston, VK4RY; C. Hedley, VK2MT; N. M. Cameron, VK3PG; G. Koenig, VQ8AC; A. Woerner, D4QET; P. F. van Cleemputte, PA0XM; S. H. van der Hulst, PA0TT; P. M. Smit, PA0LR; N. van Overvoorde, PA0NO; T. Tyama, PA0FF; J. Cohen, PA0SD; D. Zaayer, PA0UN; J. Bastide, F8JD; Paul Giovanelli, F8GR; Capitaine Rene Bertrand, F8BA; T. O. Cadell, VU2EB; Karl Heinrich, OE3KH; Byron Goodman, W1JPE; Ivar Westerland, SM5WJ; Warren Mallory, W9PGS; Andre Ferry, F8VS; Howard L. Baumann, W2AH; Alexander Maitland, W9DEF; William Obrist, W9BEZ (phone); Kenneth Bishop, W1EWD; Reid G. Smythe, W2BLD; Craig Hare, W9BDX; D. Reginald Tibbets, W6ITH; William Benson, VE3WB; Charles W. Knight, W5DYH; Leslie D. Gregg, W9IU; M. R. Johnson, W2DSB; William J. Stevens, W6LCF; Richard Grove, W6BPD; Bruce W. Peterson, W6JWL; E. J. Knoll, Jr., W3OP; K. J. Cook, SU1AQ; Mario W. Simonsen, PY2GJ; George G. Glade, W6GK;

(Continued on page 78)



Amateur Radio STATIONS



W6CNE's Mobile Rig

WE SUPPOSE there are a few of the ten-meter 'phone gang who haven't heard W6CNE hamming away while bowling along over the Southern California highways. The many who *have* heard the rig have been mighty curious about it, so here are the pictures and dope.

This is not just a station installed in a car—it's a radio car throughout. Besides the radio apparatus the car, a '36 Willys panel delivery, is equipped for emergency operation, carrying four days' rations, a two-burner stove, 25-pound ice-box, wash basin, five gallons of water, cooking utensils and dishes for four people, and bedding. The seats fold into a double bed, and a small folding table serves as a desk. Besides the above, an extra supply of heavy clothing, rubber boots and similar accessories also is carried. The inside of

the car is well lighted and is provided with an electric fan, the lights and fan running from 110 volts taken from the portable power plant.

The cabinet occupying most of the space under the dash at the right-hand side contains the station. The transmitter is capable of working on 5, 10 and 20 meters, using plug-in coils. A 6A6 oscillator-frequency-multiplier, working from a 7-Mc.

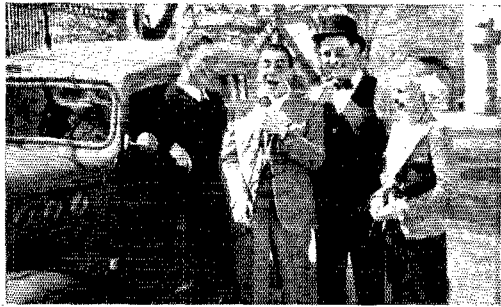

Left to Right: W6CNE, Joe Penner, Parkyakarkus, Lorraine Kruger



In This Cabinet—Transmitter, Modulator, Special 5 and 10 Meter Super, All-Wave B.C. Receiver



ALL SET FOR EMERGENCIES! THE RADIO CAR CARRIES BEDDING, STOVE, ICEBOX, AND EMERGENCY RATIONS

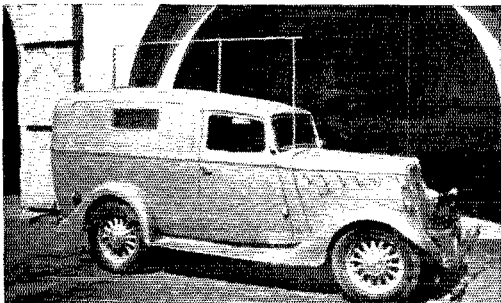

THE GAS-ENGINE DRIVEN GENERATOR IS MOUNTED IN FRONT OF THE RADIATOR GRILLE

crystal, gives output on 28 Mc. to drive an 802 buffer which in turn drives a pair of 801's in the final stage. The modulator uses a pair of 46's in Class-B. A crystal microphone, equipped with a W.E. chest mounting, is used for voice pickup. The mounting leaves both hands free for driving—an absolute necessity in Los Angeles, Roy says!

Two receivers are mounted in the cabinet. A special job is used for five and ten meters—a super having acorns in' the r.f., mixer and oscillator stages. An all-wave broadcast receiver takes

(Continued on page 88)



OPERATING NEWS



Conducted by the Communications Department

F. E. Handy, Communications Manager

E. L. Battey, Asst. Communications Manager

AUGUST A.R.R.L. ACTIVITIES are announced elsewhere in this issue. A Low Power Contest is an inviting innovation in its own right. When combined with the tried and true objectives of the Field Day, with either field or home operation possible, we have little doubt that a successful activity may be predicted. The Field Day was bigger and better than ever this June, according to early reports, and we trust it will continue to see enlarged participation in its own right. The new plan for August is a special activity to appeal to F.D. operators who want another, to bring new opportunity for any station of not more than 25 watts input to the final, to stress and encourage preparedness and self-powered capabilities for all stations.

It is impossible to devise any activity to suit all people, all groups, all objectives, and in spite of study and compromise we scarcely expect everyone to be satisfied equally. That is why different announcements are made to cover all fields. We invite all who can to enter and solicit constructive criticism and suggestions from all. When suggestions balance out, equal numbers for and against, we feel that activities are properly aimed. If a preponderance of thought is in a certain direction the plans are modified to follow this spontaneous indication, as experience in an ever changing world shows desirable. It is our aim to promote constructive activities within every amateur group where sufficient interest is shown.

This August test is a chance to try out self-powered equipment; and for the operator with modest power to compete with a station of single receiver and transmitter units in his own power class. Some members are low power enthusiasts; some are not. All should consider the emergency power supply problem which is of importance to the standing of the whole amateur service. Try your luck with 25 watts (or under) in the Low Power Contest (or F.D.) and let us hear from you.

Re the formula QSO: Brotherhood and the spirit of amateur radio, when reduced to a mechanical formula become as nothing. Real life and enjoyment are in the emotions, and happiness is not attained through sheer intelligence alone. Friendship, faith, and fraternalism require more of a person than inane adherence to a monotonous formula in sending and receiving. Amateur radio should be a means for self-expression as well as for

receiving reports. Within organized groups of amateurs we find considerably greater breadth of fraternal relationships than in the mass exchange of rudimentary data which narrows the field of too many QSOs.

The longer we operate an amateur station the more we are convinced that the hams we meet, the friendships made, the contacts over the air and exchanges of real information *are* amateur radio. Let us not ignore the really great possibilities of communicating with our stations, then. Get into interesting constructive operating groups *with a purpose*. Let us never reduce our QSOs to the "mere formula" status, but strive to have something different for all comers. To do otherwise is a symptom of mental laziness. Quality is more to be desired than quantity. One really good contact is worth a dozen perfunctory formula exchanges. This is recognized by the eager support and interest in membership in the Rag Chewers' Club.

To overcome the temptation to substitute a large number of contacts for a few very worthwhile ones, a list of questions or topics can be placed near the operating position, and used to draw out the taciturn or morose formula minded folk. There should be enough topics of the day and breadth of interest in amateur radio to make a good start for conversation possible on any occasion even without such helps. There are, of course, occasions when time is the essence and elaborations are improper. Conciseness with understandability is always desirable. But let us use our stations because we have something to communicate, not for mere trifling. Line up with O.R.S., O.P.S., N.C.R., A.A.R.S. or other constructive groups that give point to ham work. In general QSOs, as in life, have an objective. Let us use stations to get better acquainted, not only with equipment and operating technique, but with our brother amateurs. You will find that the operators worked can give you much interesting and helpful information if you will but draw them out.

— — — — —
O.B.S.

—F. E. H.

The following is a supplement to the list of A.R.R.L. Official Broadcasting Stations in October *QST* (page 122): W1JZN.

PRIZES FOR BEST ARTICLES

The article by Mr. L. R. Mitchell, W1HIL, wins the C.D. article contest prize this month. Each month we print the most interesting and valuable article received marked "for the C.D. contest." Contributions may be on any phase of amateur operating or communication activity (DX, 'phone, traffic, rag-chewing, clubs, fraternalism, etc.) which adds constructively to amateur organization work. Prize winners may select a 1937 bound *Handbook*, QST Binder and League Emblem, six logs, eight pads radiogram blanks, DX Map and three pads, or any other combination of A.R.R.L. supplies of equivalent value. Try your luck. Send your contribution to-day!

"But It Never Could Happen To Me"

By L. R. Mitchell, W1HIL*

HOW many times we have read in QST of calls being bootlegged. And how often at club meetings, conventions and during QSO's brother hams have told us of their calls being "borrowed" and "misused," of QSL cards received confirming QSO's never made, oftentimes on frequencies never used by the rightful call owner. We even hear of lads who are no longer licensed, yet continually receive cards from all parts of the world. I have heard of these conditions and have said "Isn't that too bad," or "Why doesn't someone do something about it," always with the thought in the back of my mind, "But it never could happen to me." I must confess with shame that until recently I have never tried to do anything to help correct the "call bootlegging" troubles. I never thought for one minute that any such thing would happen to me, and "thereby hangs a tale." . . .

I have for the past year operated about 95% of the time on the 1.8 Mc. 'phone band. I use a crystal frequency of 1903-kc. and have not changed due to the fact that I have three wave traps on B.C.L. receivers tuned to eliminate QRM at that frequency. Due to cases of B.C.L. QRM I have in the past received a couple of long white envelopes from the F.C.C. Upon returning home recently from a business trip I found another of these envelopes. Heck! I thought to myself, "I suppose I might as well go out to the shack and start building another wave trap." But that was before I had opened the envelope! As I started to slit it open I noticed for the first time the postmark—"Portland, Oregon." Surely my 25 watts couldn't be causing interference to B.C.L.'s in Oregon!! What, then? The envelope open, out fell a pink ticket and a green ticket. In all my years of radio operating I have tried always to accurately check my frequency and monitor my transmissions. I have always tried to put a high quality signal on the air.

It was rather difficult for me to realize that these colored slips had been sent to me and as I read the frequency report my bewilderment grew apace for it said, "Time—9:36 P.M. EST. Freq. assigned 14,000-14,400 kc.—Freq. measured 14,417,608. Deviation, High 17,608 cycles! May 18, 1937. From Radio Monitoring Station. Route 7, Box 1336, Portland, Oregon." I have never operated on 14-Mc. ('phone or c.w.) in my life. My transmitter is not equipped for such transmissions. The three crystals I own have the following frequencies: 1903, 3670 and 7098 kc. and no harmonic from these could fall on the frequency reported by the monitoring station. May 18th? That was Tuesday! I went to the shack, got out my log . . . gosh! I wasn't home from 6:15 until 10:45 and my rig was on 1.8 Mc. 'phone since I had signed off with W1AIR and had gone out to visit friends. I had come home at 10:45, called CQ on 1.8 Mc. 'phone, and not raising anyone had gone to bed. Yet I had been heard on 14,417,608 kc. in Portland, Oregon at 9:36 P.M. Something certainly was "rotten in Denmark."

* 61-A North Ave., Melrose Highlands, Boston, Mass.

Upon picking up the green slip my blood pressure went up another 10 degrees. This slip said, "A-2 Emission does not comply with the requirements of Rules 375 and 382. 9:33-9:36 p.m. calling CQ, 14,000-14,400 kc. band." Not only was the signal 17.6 out of the band, but it was A-2 emission!! This was too much for me to take. Some law breaking, inconsiderate moron had used my call and violated at least two important regulations. "But it never could happen to me"—oh yeah!

I have had my lesson. It did "happen to me." May the fellow who operated the key of that transmitter boil in oil the rest of his days! From now on I am on the trail of any and all call bootleggers and I'll never rest until I help to give them what they have coming to them. Stop and think what this bootlegging means. Think of the number of cases you never even hear about. Let's do all we can to put a stop to things of this nature before it reaches such proportions that these unlicensed punks jeopardize our amateur rights by flagrant disregard for regulations. Let's try to follow up all cases of which we hear. Make a note of the call when you hear of anyone whose call is being bootlegged. Make all notes possible on characteristics of the signal, operator's sending, voice, etc., should you hear of these calls. Estimate the location of the station, if at all possible to so do. Check with the rightful owner of the call as to whether he was on the air at the time you heard his call. Local bootleggers are, of course, easier to track down than those at greater distances. But every violator is "local" to somebody. Each individual licensed amateur and amateur clubs should take every step to locate the offenders and bring them to justice.

Stop turning a deaf ear to fellows who are "interested in amateur radio." Help make theirs a legitimate interest. Find out just what they are doing. Help them get started in the right way. Make clear to them the seriousness of call bootlegging and unlicensed operation. Let's go after the bootleggers and save the amateur bands for our own use. How about starting a club of operators banded together to stamp out this evil? I would be interested in hearing from operators interested in such a movement. Let's have your suggestions on locating these bootleg stations. Sooner or later these birds get bold and let slip where they are located, or give out other information to aid in their apprehension. We should have no computations on turning over to the F.C.C. all information available on unlicensed and bootleg stations, if other steps fail in getting the operators to cease operations. It's the only way we can ever purge our bands of these criminals. What say, gang? Are you with me?

Local amateur radio clubs have a definite responsibility to themselves and to the properly licensed amateurs of their communities in setting up controls and establishing policies (1) to locate and do away with bootleg operations in any amateur frequency band and (2) to give proper helps and encouragement to newcomers in the game who have a correct and sincere interest in amateur communication. A.R.R.L. will send a marked bulletin giving any club information on the practices adopted and followed by leading affiliated clubs in control of unlicensed operation on request.

Briefs

W5EOW heard one ham say, in defense of rotten sending, "I send this way so that only a licensed ham can read my call. Then I am not bothered by listeners' cards." Well, that may be one way of looking at it!

GI6XS is interested in 56-Mc. schedules for transatlantic tests during the next six months. Any W or VE who would care to cooperate should get in touch with him as soon as possible. Either write W. Sullivan, "Gillhall," Groomsport Road, Bangor, North Ireland, or watch for GI6XS on 14 Mc. any evening starting at 1900 GT.

W8FQZ of Gloucester, Ohio, furnished communication from that town when outside telephone and telegraph lines were down following a storm in June. W2JCL and W8MPG handled one of W8FQZ's messages.

How's DX?

How:

About the time you get around to reading this, if any, you will probably be concentrating on how nice the water is down at the old swimming hole and other such summer thoughts. A soft seat on a shaded veranda with the musical accompaniment of ice tinkling in a tall thin glass will probably have much more lure than the stuffy shack and its squadrons of wasps and mosquitoes strafing any human without mercy. Your active radio work may be confined to contemplation of the new rig that will be built (or rebuilt) in early fall, and it is with this in mind that we'd like to make a suggestion. If you are going to make any claim of up-to-dateness, you can't overlook the business of quick frequency change. Not necessarily being able to go from 160 to 10 by the flick of a switch, but you should be able to jump around within the same band, and do it fast enough to get a fellow before he signs over. W6CUH set the standard with his splendid transmitter described a few months back, but everyone hasn't the money or facilities to do such a thorough job. But no modern oscillator stage should be built without provision for switching of several crystals, and you might give the idea of relays cutting in padders in the following stages some consideration. Or you might have some other ideas on how to do it. The main point, however, is to do some work on it, else you are going to find yourself left in the lurch when the DX rolls in. The old philosophy of a kilowatt-plus smack on the edge of the band as the ultimate may be all right in some instances, but if you have ever operated a quick-changer you'll never go back to the old stuff. Give it a thought, anyway.

Where:

If you have worked UX1CR (T9, around 14,400 kc.), like W3CHH and W3DVE have, you will find Rudolf Island, the QRA he gives, is Prince Rudolf Island, 900 kilometers from the North Pole. UX1CR seems to be authentic, probably operated by U1CR. QSL via the C.B.S.K.W. Then there's this fellow UPOL (T9, around 14,400 kc.), reported by W1EWD, W2CYS, and others. We haven't much dope on him, but it's supposed to be the Soviet Polar Expedition R. N. Fox, of British Political Mission,

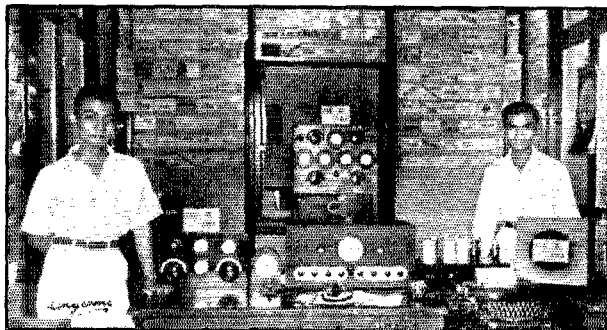

HS1BJ-HS1PJ-HS1RJ, AT SALADONG, BANGKOK, SIAM
Sangiem Powtongsook, the owner and operator, is shown at the right. The three rigs are: HS1PJ, 14,200 kc., 400 watts; HS1RJ, 14,380 kc., 50 watts; and HS1BJ, 14,070 kc., 5 watts. (Photograph courtesy of W6GPB).

Llasa, via Gyantse, Tibet, and ex-VU2DR, writes in to say that he is now the only operator of AC4YN (see February QST). His letter, written in May, says he needs a W or VE for WAC, but he may have them by now. Anyhow, if you work him you are due to receive a snorty QSL card, Lama-designed and hand-painted These fellows using the prefix "XZ," like XZ2DY (14,300 kc., T9),

XZ2JB (14,010 kc., 'phone), and XZ2EZ, are not phonies. The prefix of Burma has been changed from VU to XZ, to avoid confusion (we almost said Confucian), according to advice from W6MX, W6ITH, and W9OKZ Don't pass up K6LHA (7275 kc.) if you run across him. It's Dick Hansen, ex-W6DTZ, now at Wake Island with PAA W9TWC passes along the QRA of PK2CG (14,260 kc., T9); P. P. Moens, c/o Telephone Office, Semarang, Java, D. E. I. W1EH says that if you work that T5 signal of VQ4CRI someday on 20, your card should be sent to W. A. Campbell-Gillies, P. O. Box 21, Nairobi, Kenya Colony. The rig is a 30-watt MOPA What do you know about these? ZD4CB, worked by W8QBQ; VX4PG, worked by W9RAO; or B2KF, worked by W6MX Another fellow in Clipperton Island may be FKKQ, worked by W9AJA W8IGQ, who at present is operating WCFT somewhere in Pacific waters, advises that YJIRV hasn't been on for eighteen months, so someone has been bootlegging his call. But the real YJIRV will be back on shortly, with 50 watts or so A station on in Iraq is news, so that makes Y12BA (14,185 kc., T8c) news. His QRA, via W2BMX, is c/o Post Office, Margil Basra, Iraq. He has been rapping through during the evenings If you haven't worked the Solomon Islands, look for VR4AD (7020 kc., T9) around 4 A.M. EST. WCFT scared him up and got him on the air T4TWO, worked by W2CYS and W9VPG, says he is at Dakar, French West Africa.

When:

W8MAH reports Asians coming through in the early morning, with XU7Y (14,400 kc., T9x), J2JJ (14,270 kc., T9), and J2KJ (14,260 kc., T9) among the better ones. He adds that F2PX is not a phoney, since W8PMQ had a letter acknowledged by the station at Miquelon W6MX worked his Cuban, at last, and mentions some choice ones like VU2LJ (14,300 kc., T9) FT4AG (14,400 kc. T9), HS1BJ (14,100 kc., T9), FY8A (14,400 kc., T7) (VES2A 14,050 kc., T9), F8AB (14,330 kc., T9), PK3AA (14,150 kc., T9) and HK4EA (14,400 kc., T5) W9TWC's contribution to the literature of the month includes PK6XH (14,270 kc., T7), U3QT (14,390 kc., T9), FT4AK (14,385 kc., T8), VS1AD (14,335 kc., T9); and between 14,255 and 14,300 kc., J2JJ, J5CI, J2LU, and J7CR According to W1DIR, who worked him around 11:30 p.m., EDST, VS2AB (14,260 kc., T9x) uses a directive antenna in this direction, and has a walloping signal Nice ones at W9VPG include PK6AR (14,270 kc.), HR2AC (14,440 kc.), and J2NQ (14,330 kc.) While working with a 25-watt portable rig, W8OIV snagged YV5AO (7150 kc., T9x) The Spanish stations are nearly all on 'phone, if you have been looking for them.

What:

A tip to users of electron-coupled oscillators, from W1HOV: If you have trouble with your EC oscillator creeping, make sure that you have aluminum and not brass plates in the grid condenser. Brass expands a great deal more with temperature changes than does aluminum and, in W1HOV's case, the substitution of an aluminum-plate condenser for a brass-plate one solved his problem of creeping.

Who:

We have it via the grapevine that Dave Evans, W4DHz, is planning to move out west and go in with W6CUH on a combined station. If it turns out to be so, we can look for still more DX records to be busted by them, but their big problem will be trying to find stuff they haven't already

worked. Maybe they'll subscribe to the DX expedition This is not the "Missing Persons" department, but W2BRR received a batch of cards from FY8C including ones for W2BX and W2HX, but FY8C apparently copied the calls incorrectly, since they aren't listed. The contacts were made during January, 1937, and you can claim the cards, if they belong to you, by dropping Artie a line Credit where credit is due is our motto, but we somehow have the feeling that W2ENY's 28-Mc. contact with ES5D on March 4th was not the first W/ES on that band. Check? And W1FH thinks maybe his QSO with TA1CC (14,280 kc., T5) on June 11th was the first W/TA LA2X (14,284 kc., T9x) and 11IR (14,440 kc., T9) need Delaware for WAS, and contacts with Arkansas, Delaware, and Wyoming, would make ZL3GR (14,340 kc., T8) very happy VQ3MSN advises that his station is no longer on the air and that someone is borrowing his call W11CB-W2GVX knows now that this QRP stunt is not exactly the bunk. He worked PA0QZ, and finally cut the power down to 5 watts input to a doubler stage, with an S6 report The first DSM award in the United States went to WIJPE, and W6ITH gets the second one It has been our pleasure to meet several of the QSL Managers, and we've found that they are usually pretty good fellows. All they ask is that you send in a self-addressed stamped envelope, and if you have any DX cards coming to you they'll ship them back. Simple, isn't it? Yet you'd be surprised how many DX-ers have let their cards pile up at the QSL Manager's shack, instead of claiming them. You can find the address of the QSL Manager for your district in *QST* each month.

—WIJPE

Briefs

20-Year Club

How many hams have been in the game for 20 years or more? W9WZE suggests that it would be interesting to know which of the fellows we hear and work are such old-timers. We invite all who were licensed 20 or more years ago and who have an amateur call at the present time to send us a brief chronology of their ham careers. Particularly do we want the date you started in amateur radio, your call letters at that time, any other calls you may have held in the intervening years, and the call you hold to-day. Many old-timers are hiding behind new calls—let's have the dope, OM's.

W6GZU, Phoenix, Ariz., used to keep daily schedules with W9DEG in Iowa. They never had met personally but, after a long period of schedules, decided to go into partnership in a radio business in Coolidge, Ariz. W9DEG came West and W6GZU secured a year's leave of absence from the Phoenix Police Department. They are now in business as planned.

Cross-Country Net

W9RWS, O.R.S., is Net Control Station of a new traffic net operating in the early mornings on a spot frequency of 7208 kc. during the summer months. 3604 kc. will also be used in the winter. The aim is to have at least one net station in each of the forty-eight states. Included in the present membership are: W9RWS, Farmington, Ill.; W9WFS, Chicago; W9VET, Minneapolis; W9EYH, Milwaukee; W8MAE, Cleveland; W9SDG, Anchorage, Ky.; W4BBV, Gainesville, Ga.; W9UZQ, Indianapolis; W9UIQ, Racine, Wis. If you are interested in joining this group, communicate with W9RWS, Max M. Bolton, Farmington, Ill.

At Fort Knox, Ky., the Mechanized Cavalry and Artillery operate a large number of radio transmitters in armored cars and tanks. At present vacancies exist for enlistment of operators for these sets, and for qualified radio repairmen.

Amateurs, unmarried and over 18 years of age, living in Kentucky, Indiana and Ohio, or neighboring states, should write for particulars to the Signal Officer (W9YHQ), Fort Knox, Ky.

W1EH worked all VE districts in his first five QSO's on 7 Mc. the Friday night of the VE/W contest.

The Oklahoma Section Net is one of the few that keeps moving during the summer months. The following report in each morning on 3682 kcs: W5EMD, Bartlesville; W5ENN, Tablequah; W5EGP, Muskogee; W5DTU, Oklahoma City; W5FSK, Ft. Sill; W5GFT, Enid; and W5CEZ, S.C.M., Ponca City, the control. This net works into the A.A.R.S. net through a daily schedule between W5CEZ/WLJC and W5OW/WLJ and a W5FSK-W5OW connection.

An interesting field test of portable/emergency equipment was made on the afternoon of April 4th by a group of Nebraska amateurs. The equipment, the property of W9EKK of Lincoln, consisted of a portable transmitter using an 89 crystal oscillator, 42 and a pair of 42's final, with about 7 watts input from a dynamotor operating from two six volt storage batteries; modulation was accomplished with a single button mike (hand type), 77 speech amplifier working into a single 6B5 Class A modulator. Receiver was a rebuilt automobile super. Antenna consisted of an 8-foot vertical metal rod, mounted on the car and tuned by means of a Collins network. All transmissions were on 1.75 Mc. radio-telephone, using a frequency of 1911-kc.

W9EKK and another operator left Lincoln at 2:00 P.M. and drove to Weeping Water, a distance of 34 miles, and back again. 100 percent contact was maintained with the car from both ends, Lincoln and Weeping Water, at all times. Brief stops (about two minutes) were made for each transmission, 16 stops being made, with the logs checked at each station receiving. W9TVS and W9EHW operating W9EHW with two receivers made excellent three-way contact with the car and with the control station, W9RIE, in Lincoln. Contacts were maintained as a directed net, with W9RIE the key station in Lincoln, and W9EHW and W9VFL in Weeping Water. The outstanding part of this work is, of course, that it was accomplished on 1.75 Mc. 'phone. The following amateurs participated in the test: W9EKK FWL RIE SNI HAK WKP WBU JHR VFL EHW TVS.

N. I. P. A.

Rho Epsilon, fraternal organization of college amateurs, is sponsor of the Northwest Intercollegiate Press Association, an amateur radio news exchange service between college newspapers. At present there are three Rho Epsilon chapters, Alpha Chapter at Washington State College, Beta Chapter at the University of Washington and Gamma Chapter at the University of Idaho. The Beta Chapter has 20 members. W7LD at the U. of W. has schedules lined up with W7BVE, a student at the University of Montana, W7YH, station of the Alpha Chapter at W.S.C., and W7EYL at Oregon State College. Spot-frequency operation on 3585 kc. is contemplated. Amateurs attending colleges in the Northwest are invited to communicate with W7LD relative to joining the N.I.P.A. Address Niilo Koski, 5822 East Green Lake Way, Seattle, Wash.

Bill Stull, W8DHL, ex-K6JPT, WLM/W3CXL, WVE, WTJ, WAR, is now in the Air Corps stationed at WYO, Langley Field, Va. He advises that Vance Murr, well known as W3BAI at Bolling Field, Washington, D. C., is now with Eastern Airlines, Miami, Fla.

W5DZY handled a message from W9WWB to W6FQU which resulted in locating a missing man whose daughter had died.

BRASS POUNDERS' LEAGUE

(May 16th-June 15th)

Call	Orig.	Del.	Rel.	Extra Del. Credit	Total
K80GD	306	231	2122	100	2759
W6JTV	93	272	191	216	172
W6TTH	153	212	197	187	749
W6DH	22	89	592	29	732
W7DUE	56	49	466	49	620
W6IOX	36	173	214	173	596
W6LLW	11	21	516	16	564
W3BWT	32	65	394	45	510
W7FVK	25	38	411	31	505

MORE-THAN-ONE-OPERATOR STATIONS

Call	Orig.	Del.	Rel.	Extra Del. Credit	Total
W5OW	142	292	546	135	1115
W9BNT*	197	223	564	—	984

These stations "make" the B.P.L. with total of 500 or over. One hundred deliveries+ Ex. Del. Credits also rate B.P.L. standing. The following one-operator stations make the B.P.L. on deliveries. Deliveries count!

W6MGL, 314	W3QP, 180	W6BQO, 108
W6IMT, 209	W7EBQ, 111	W7AFS, 108
	W1ARS, 110	

A.A.R.S.

Call	Orig.	Del.	Rel.	Extra Del. Credit	Total
WLMI (W6GXM)	82	129	672	—	883

MORE-THAN-ONE-OPERATOR STATIONS

Call	Orig.	Del.	Rel.	Extra Del. Credit	Total
WLM (W3CXL)	203	157	1404	—	1764

A total of 500 or more, or 100 deliveries Ex. D. Cr. will put you in line for a place in the B.P.L.

* Mar.-Apr.

Expedition Notes

MacMillan Arctic Expedition

The Schooner *Gertrude L. Thebaud*, MacMillan Arctic Expedition, sailed from Gloucester, Mass., on June 24th to return in September after visiting Newfoundland, Baffin Land and Labrador. The ship is licensed under the call WHFN to transmit on the following frequencies: 468, 500, 4140, 5520, 8280, 11,040, 16,560 and 22,080 kcs. Relay broadcast channels at 8655 and 12,862.5 kcs. may be used with the call W10XH. Walter H. Ramsten, ex-9DFF, an A.R.R.L. member, is the operator. WHFN/W10XH is Zenith-equipped. Schedules have been arranged with VE1IN (Bowdoin-Kent's Island Expedition), W9AQS, Mt. Prospect, Ill., and WLM, Washington, D. C. Schedules with VE1IN were scheduled to start July 5th at 2300 GT on 4140 kc. or at 2330 on 8280 kc. WLM schedules were to start July 1st on 8280 kc. at 0100 GT. Some general work with amateurs is also expected so keep an ear open for WHFN/W10XH.

MacGregor Arctic Expedition

A. G. Sayre, W2QY, O.P.S./O.R.S., is radio operator with the MacGregor Arctic Expedition, which sailed June 27th from Port Newark, N. J. The expedition's ship is the old polar ship *General A. W. Greeley*. The call WAWG will be used. Two-way work with amateurs is contemplated using 3115, 4145, 5525, 8230, 8290, 11,050, 12,460, 16,580 or 22,100 kcs. The expedition will be out for 18 months to three years with base at Fort Conger, close to the Pole.

Bowdoin-Kent's Island Expedition

Station VE1IN of the Bowdoin-Kent's Island Expedition will be in operation from July 5th to September 15th using the following frequencies: 14,285, 3510, 3576, 3860, 3885, 3927, 3861, 3996.5. Both 'phone and c.w. will be used. The operator is George R. Cadman, W2FEF, operator at W1OR (Bowdoin College) for several years. VE1IN will relay much

of the traffic originating from the Macmillan expedition and anticipates a total of about 600 messages per month. Schedules will be maintained with various stations to clear this traffic. Tentative schedules have been arranged with W1AW, W1BDI, W1ES and W1UE. Thomas A. Gross, W1JZM, is manager of VE1IN and in charge of engineering.

From W6JTV, East Bay S.C.M., comes word that the Schooner *Wander Bird*, KMUP, has sailed for a two months' cruise to the islands and return. Her calling frequency is 6210 kc., working frequency 6230 kc. W6JTV and W6OBJ spent all of one Sunday afternoon working on KMUP's transmitter, checking it for the trip.

1937 DJDC

Second Annual German DX-Contest

THE "DJDC," Deutschen Jahres-DX-Contest, under the auspices of the D.A.S.D., is to be an annual event.

The DJDC consists of two parts as it did in 1936, the DX-QSO between European and overseas stations, and the QTC-traffic between German and non-German amateurs. During the DX-QSO, serial numbers are again exchanged for verification.

Time and Frequencies: The contest takes place on all week-ends of August 1937, starting on the 7th at 1200 GMT and lasting each week-end up to 2400 Sundays. All amateur bands may be used; German amateurs are prohibited to work on 1750 and 56,000 kc. bands, and the 3600 to 4000 kc. part of the 3500 kc. band. Stations frequently observed working outside the bands may be disqualified.

Contest QSO's: The base of the contest is formed by the maximum possible number of contacts between European and overseas stations. For verification, six-character serial numbers are exchanged, if points are claimed for the QSO. The serials consist of two three-character numbers, the first meaning WRT or RST, the latter the running number of the QSO, thus starting with 001. The general call for contest QSO's is CQ DJDC. QSO's are permitted only once between the same stations each week-end, and on each frequency band. QSO's between European and German stations do not count.

QTC-Reports: Contest QSO's having taken place between non-German and overseas amateurs may be reported once each to Germany by each of the participants. Each QSO with European countries other than Germany creates a "QTC-report," which consists of the call of the worked station, local time of the QSO in four-cipher number, and the serial number received. Example: ON4AU reports to D : W6CUH 0515/589012. This means ON4AU has worked W6CUH any day of the contest at 0515 his local time and received the serial 589012. This serial means with its first three characters that W6CUH heard ON4AU RST 589, the latter three characters mean the 12th QSO of W6CUH. At his end, W6CUH would be able to report this QSO in the following manner: ON4AU 2115/579005. That means, the QSO took place at 2115 W6-local time, ON4AU heard W6CUH RST579, and it was the 5th DX-QSO of ON4AU.

You may send to each German station a QTC-report for every non-German station worked. You may work the same D-station as many times as you like for the purpose of sending these reports. Schedules for sending your QTC-reports always to the same D-station are permitted. The German receiver has to acknowledge the correct reception of the QTC-report (i.e. 5 QTC ok), before points may be claimed. QSO's between overseas stations and Germany may be followed by QTC-reports to the same D-station. QTC-reports cannot include D . . . calls, and that QSO's for sending QTC reports are permitted only with Germany.

Scoring: The scoring is done by points.

QSO's between Germany and overseas: 2 points each 1000 km. or part of it.

QSO's between other Europeans and overseas: 1 point each 1000 km. or part of it.
 For each QTC-report correctly acknowledged by a German station you may claim:
 QTC-reported by a European station, 6 points each QTC.
 QTC-reported by an overseas station, 3 points each 1000 km. or part of it.

All points are totaled and multiplied by the number of German districts worked. The German districts are expressed by the last letter of the D . . . call. There are 19 German districts represented by the final letters of the calls: A, B, C, D, F, G, H, I, J, K, L, M, N, O, P, R, T, U, V, Danzig, YM4 is considered as Germany and forms the 20th German district. Differences between ciphers D3 or D4 are not regarded.

Prizes: There is no world winner, the participants of each country competing striving amongst themselves. Regardless of their score, all participants will receive from the D.A.S.D. a verification of their participation in the "DJDC 1937" and a list in which the results of the contest are published. The top scorer of each country will receive an artistic prize. If there are more than 5 participants, two prizes are awarded. In Germany, U.S.A., Canada and Australia, each licensing district is to be considered a "country." If more than one amateur is working at the same transmitter, each must submit a log of his own. Competition is between operators, not stations.

Logs: There are no entrance formalities. Just send the D.A.S.D. your completed log. The log has to contain (for each contest QSO) date, time, band, station worked, serial received and sent, and the points claimed. Non-German stations must indicate to what German station QTC-reports were sent and when the QTC-QSO started. The head of the log must show name, address and call, power input and the type of receiver used. The final score must be calculated. All logs must reach the D.A.S.D. not later than November 30th, 1937. Play safe, OM, and mail the log just after the end of the contest! Every participant is urged to send his log. In the 1936 DJDC about three hundred participants did not send any log, so that checking was very difficult! Send a log, OM, and you know you will get a nice remembrance token in the shape of a verification card for the 1937 DJDC! Mail log to Deutscher Amateur-Sende-u. Empfangsdienst e.V., Berlin-Dahlem, Cecilienallee, 4, Germany.

Hamfests Scheduled

July 31, August 1-2: The fifth annual Jenny Lake Hamfest (WIMU) will be held these dates at Jenny Lake, near Moose, Wyoming. It is an informal affair. All amateurs are invited and urged to bring along the wife and kiddies. Entertainment will be provided for all. It is suggested that where possible those attending bring camping equipment as indications point to over-crowded cabins. Those desiring cabins should get in touch with W7AEC. Further details on the 'fest may be obtained from W7AEC, W7AMU or W7NH.

August 1: At Clatty's Driving Range, Bowerhill Road, Mt. Lebanon, Pittsburgh, Pa., the fourth annual Hamfest of the South Hills Brass Pounders & Modulators. A gala program is planned with real prizes, good eats, plenty of fun and interesting speakers. It is an afternoon affair, registration 75¢, covering everything.

August 1: Radiomen of Cleveland, Ohio, announce an outing for their shut-in friends to be held at Puritas Springs Park, Cleveland, all day Sunday, August 1st. Everyone is invited: amateurs, their friends, shut-ins and their friends, SWL's and the general public. W8LXV is a member of the planning committee. For complete details write John E. Garvey, 2141 W. 67th St., Cleveland, Ohio.

August 3: At Justice Park Gardens, Archer and Kean Avenues, Chicago, the Hamfesters Radio Club, Inc., will hold its fourth annual Picnic. Games, races, refreshments and dancing make up the program. There will be prizes galore with an RME-69 as the grand prize. Prizes will be awarded to the holders of winning tickets whether or not they are present at the drawing. Out of town hams may secure tickets at 35¢ each from the club secretary, Chet T. Horton, 3732 South Laffin Street, Chicago.

August 22: The Annual Hamfest and Picnic of the Marin Radio Amateurs will be held at McNear's Beach, out of San Rafael, California. A tri-club (Marin, Oakland, San Francisco) baseball game is scheduled with the Division Director and Alternate Director as umpires. The usual fine bunch of prizes will be raffled. There will also be an exhibition of manufactured equipment and other radio gear. Complete information is available from the club secretary, W6JBZ.

ELECTION NOTICES

To all A.R.R.L. Members residing in the Sections listed below: (This gives the closing date for receipt of nominating petitions for Section Manager, the name of the present incumbent and the date of expiration of his term of office.) This notice supersedes previous notices.

In cases where no valid nominating petitions have been received from A.R.R.L. members residing in the different Sections in response to our previous notices, the closing dates for receipt of nominating petitions are set ahead to the dates given herewith. In the absence of nominating petitions from Members of a Section, the incumbent continues to hold his official position and carry on the work of the Section subject, of course, to the filing of proper nominating petitions and the holding of an election by ballot or as may be necessary. Petitions must be in West Hartford on or before noon of the dates specified.

Due to a resignation in the Eastern Florida Section, nominating petitions are hereby solicited for the office of Section Communications Manager in this Section and the closing date for receipt of nominations at A.R.R.L. Headquarters is herewith specified as noon, Monday, August 23, 1937.

Section	Closing Date	Present SCM	Present Term of Office Ends
Eastern Pa.	July 15, 1937	James M. Bruning	Aug. 7, 1937
Alaska	Aug. 16, 1937	Richard J. Fox	Sept. 3, 1937
Maritime*	Aug. 23, 1937	Arthur M. Crowell	June 14, 1937
Nevada	Aug. 23, 1937	Edward W. Helm	June 14, 1937
Ga.	Aug. 23, 1937	Bannie L. Stewart	Dec. 14, 1936
Cuba-I. of P.-P. R.-V. I.			
Oklahoma	Aug. 23, 1937	Carter L. Simpson	Feb. 15, 1936
Eastern Florida	Aug. 23, 1937	William C. Shelton (resigned)
West Virginia	Aug. 23, 1937	Dr. Wm. H. Rhinolfatter	July 12, 1937
Eastern Mass.	Sept. 1, 1937	Albert N. Giddis	Sept. 16, 1937
Eastern N. Y.	Sept. 1, 1937	Robert E. Halgait	Sept. 16, 1937
Missouri	Oct. 1, 1937	J. Dewey Mills	Oct. 15, 1937
Wisconsin	Nov. 1, 1937	E. A. Cary	Nov. 15, 1937
British Columbia*	Nov. 1, 1937	Don E. Vaughan-Smith	Nov. 20, 1937

* In Canadian Sections nominating petitions for Section Managers must be addressed to Canadian General Manager, Alex Reid, 169 Logan Ave., St. Lambert, Quebec. To be valid such petitions must be filed with him on or before the closing dates named.

1. You are hereby notified that an election for an A.R.R.L. Section Communications Manager for the next two year term of office is about to be held in each of these sections in accordance with the provisions of the By-Laws.

2. The elections will take place in the different Sections immediately after the closing date for receipt of nominating petitions as given opposite the different Sections. The Ballots mailed from Headquarters will list in alphabetical sequence the names of all eligible candidates nominated for the position by A.R.R.L. members residing in the Sections concerned. Ballots will be mailed to members as of the closing dates specified above, for receipt of nominating petitions.

3. Nominating petitions from the Sections named are hereby solicited. Five or more A.R.R.L. members residing in any section have the privilege of nominating any member of the League as candidate for Section Manager. The following form for nomination is suggested:

(Place and date)

Communications Manager, A.R.R.L.
 38 La Salle Road, West Hartford, Conn.

We, the undersigned members of the A.R.R.L. residing in the Section of the Division hereby nominate as candidate for Section Communications Manager for this Section for the next two-year term of office.

(Five or more signatures of A.R.R.L. members are required.)
 The candidates and five or more signers must be League members in good standing or the petition will be thrown out as invalid. Each candidate must have been a licensed amateur operator for at least two years, and similarly, a member of the League for at least one continuous year, immediately prior to his nomination or

the petition will likewise be invalidated. The complete name, address, and station call of the candidate should be included. All such petitions must be filed at the headquarters office of the League in West Hartford, Conn., by noon of the closing date given for receipt of nominating petitions. There is no limit to the number of petitions that may be filed, but no members shall sign more than one.

4. Members are urged to take initiative immediately, filing petitions for the officials for each Section listed above. This is your opportunity to put the man of your choice in office to carry on the work of the organization in your Section.

—F. E. Handy, Communications Manager

ELECTION RESULTS

Valid petitions nominating a single candidate as Section Manager were filed in a number of Sections, as provided in our Constitution and By-Laws, electing the following officials, the term of office starting on the date given.

North Dakota	Ernest Bloch, W9RZA	June 14, 1937
Northern Minnesota	Edwin L. Wicklund, W9IGZ	June 15, 1937
Idaho	Carl Eichelberger, W7EMT	June 15, 1937
Southern New Jersey	W. W. Filson, W3BEI	June 15, 1937
Northern Texas	Lee Hughes, W5DXA	June 15, 1937
Sacramento Valley	J. L. C. Buckenham, W6GZY	June 15, 1937

In the San Francisco Section of the Pacific Division Mr. Alan D. Whitaker, Jr., W6SG, and Mr. Henri J. Ballros, W6LMD, were nominated. Mr. Whitaker received 71 votes and Mr. Ballros received 17 votes. Mr. Whitaker's term of office began May 28, 1937.

In the Maine Section of the New England Division Mr. Winfield A. Ramsdell, W1FBJ, and Mr. Clayton W. Hanson, W1INW were nominated. Mr. Ramsdell received 64 votes and Mr. Hanson received 47 votes. Mr. Ramsdell's term of office began June 7, 1937.

A.R.R.L. Headquarters Operators

Hal Bubb, "Hal," Chief Opr. W1AW

The following calls and personal sines belong to members of the A.R.R.L. Headquarters gang:

W1AL, J. J. Lamb, "jim"
 W1AW, A.R.R.L. Headquarters Operators Club
 W1BAW, R. B. Beaudin, "rb"
 W1BDI, F. E. Handy, "fh"
 W1CBD, C. B. deSoto, "de"
 W1DGF, George Grammer, "gg"
 W1EH, K. B. Warner, "ken"
 W1ES, A. A. Hebert, "ah"
 W1GS, F. C. Beekley, "beek"
 W1JBJ, Thomas W. York, "tom"
 W1JEQ, Vernon Chambers, "vo"
 W1JFN, A. L. Budlong, "bud"
 W1JPE, Byron Goodman, "by"
 W1JTD, Hal Bubb, "hal"
 W1SZ, C. C. Rodimon, "rod"
 W1TS, Don Mix, "don"
 W1UE, E. L. Battey, "ev"

STATION ACTIVITIES

CANADA

MARITIME DIVISION

MARITIME—SCM, A. M. Crowell, VE1DQ—Nova Scotia: FQ has the rig going nicely on 14 Mc. 'phone. JK is going strong on 3690 kc. with the '03A. EP was heard at the old bug on 14 Mc. DQ is testing out the new rig in new shack. Interesting information furnished by EE and KZ on the St. John gang and Loyalist City Amateur Radio Club: BF landed a commercial job. EE blew another transformer. FL has some new bottles. GP worked Egypt on 14 Mc. 'phone. IZ boosted his power on 56 Mc. by using a single '19. JN finally got his 6L6 neutralized on 56 Mc. BM has a new 56 Mc. rig. KZ has gone in for experimenting. EV shoots in the usual fine report for the Moncton boys and now sports an RME69 receiver. CX is building a new rig. JU moved to a new QTH and has a 6L6 c.c. osc. doing business. GI is putting up a new mast. BB schedules KS on 1.75 Mc. DC has new shack nearly ready for business. EL annexed a new power transformer. KO had a visit from KS of Sackville. IJ's landlord built him a new ham shack. FF returned to 3.5 Mc. HY is a new ham in Moncton with

a pair of '46's final JP, another new man, is going with a '45 Hartley.

Traffic: VE1JK 4 EV 5.

ONTARIO DIVISION

ONTARIO—SCM, Fred H. B. Saxon, VE3SQ—R.M.'s: 3ABW, 3DU, 3GT, 3MB, 3QK, 3TM, 3WK, 3WX. P.A.M.: 3NX. Three Ontario Section prize winners in the VE/W contest were presented with their prizes at a meeting of the Queen City Club, which was sponsor of the contest. GT and IR each received '03A's, JT received a pair of 801's. ACI now has an HRO receiver. NC put up 60 foot towers for a 267 foot flat top, running East and West and in half an hour on 14 Mc. 'phone had worked EI2L, VE3DK and LU7AC. ALU has new QTH. ALT is back home in Kirkland Lake after a series of operations in hospital in Toronto. We are glad to hear that he is like his old self again. AGM has new rig going FB with 585 watts input to a pair of 100TH's. AJB is at summer school. BY has '47 crystal, RK23 and T55 on 3850 and 14200 kc. OO is newcomer at Newmarket. YQ is fighting 14 Mc. 'phone QRM. AW is proficient at cracking rocks in a 6L6 circuit. PS is building a home instead of a transmitter. AEW is on 14 Mc. with a single '45. AMP is infected with 56 Mc. OI is getting a spot of DX on 14 Mc. WV has completed W.A.S. ACF and AJF are sailing the Great Lakes for the summer. YN is changing over to 'phone. CA is rebuilding to p.p. T55's and is looking forward to O.P.S. CG reports from Winnipeg. WK has new QTH. TM is rebuilding to high power. DH reports via radio. GT runs low power in early mornings and reports good going. GT, SG, JI, WK, ZE, IX and ADO ganged up for Field Day with 6L6 osc. and 35T final with power from a 300 watt generator driven from brake drum of car. 59 stations were worked for a total of 936 points. SG supplied a pair of portable masts of which the gang like the appearance. QK has an ATR219 transceiver on 56 Mc. and reports a lot of fun so far. The Frontier Radio Club and the Southern Ontario Radio Association, both of Windsor, were out for the Field Day, as separate units, and located about seven miles apart.

Traffic: VE3SG 21 DH 17 CA 8 AGM-KM 6 SS 2. (April-May: VE3DH 30.)

QUEBEC DIVISION

QUEBEC—SCM, Stan Comach, VE2EE—We apologize for stating that the 'phone W.A.C. honors were confined to this district. VE5OT would have us know that he also has achieved this. BE has practically recovered from his slight accident, but we regret to learn that AR is now confined to bed with a broken ankle. AP will soon be back with us after his trip to Bucharest; John did a fine job and his District is proud of him. BW recently joined the ranks of the Benedicts. Correction . . . the pole on the roof at EX is 40 feet long, not 10 feet, as stated in last issue. LC and LV went out with a portable on Field Day; results: one receiver cabinet badly warped, numerous mosquito bites and two tempers sadly ruffled. HH is at last putting his rig on 14 Mc. AA purchased a new receiver. We understand that Gordy, ex-2GE, is returning to our District. BK returned from an extended vacation among the W's. CH, an old timer with a new call, operates 3.5 Mc. 'phone. CR is rebuilding. EE has completed the new rig. DU bought an FBXA from HP. ID spent his vacation in New York City. IE built a portable to take with him to his summer home. 3COT is engaged to a Canuck; congrats to both. IJ is working in Montreal and vicinity for B. T. Co. GA is doing great work on 14 Mc.; Joe has been W.A.C. four times.

Traffic: VE2HH 4 KF 4 HT 44.

VANALTA DIVISION

ALBERTA—SCM, Alfred D. Kettenbach, VE4LX—EO is using a T55 on 3.9 and 14 Mc. 'phone. GM is active in local civic affairs. HQ visited SW, and made a tour of the District as R.I. LA rebuilt. HK and XYL visited LA and assisted in putting LA's tower back in place. GE is working 'phone regularly. TB, ex-Vegreville, is now located in the new Army barracks, Calgary, and invites local and visiting hams to look over the new QTH. ACF is rebuilding rig and receiver. CT is active again. IZ discovered a means of filter-

(Continued on page 84)



CORRESPONDENCE

The Publishers of *QST* assume no responsibility for statements made herein by correspondents

Commercial QRM

RCA Bldg., 30 Rockefeller Plaza, New York
Editor, *QST*:

We received to-day a postal card from an amateur who evidently prefers to remain anonymous. The postal card is postmarked Detroit, Michigan, and carries the following correspondence:

"Have you got a pull
wid Inspectors?
June 1, 1937

Howdy Ham
Hog

WEA R.P. 5:15 P.M.
WEN New Brunswick

"Sa OM since when did you get permission to get into our hamband? Ur RST 589 hr OM fb How about making sked wid me? I got a pink ticket one time for being just 3 kc. outside of band."

WEA, located at Rocky Point, operates on 10610 kc. with excellent frequency stability and, so far as we are able to determine, quite free from spurious emission. WEN, at New Brunswick, N. J., operates on 7407.5 kc. with excellent frequency stability and, so far as we have been able to ascertain since receipt of this amateur's report, free from spurious radiation in the 80-meter amateur band. Our frequency records show that WEN has in the past radiated sufficient half-frequency energy from an intermediate amplifier stage to be audible at our Riverhead, N. Y., receiving station. Whenever thus observed, the fault, denaturalization, was immediately corrected.

My purpose in sending you copy of this communication is a desire that, through the columns of *QST*, you might be able, editorially, to invite amateurs to advise us in each instance where they find spurious emission by any of the RCA transmitters. We receive such reports occasionally and appreciate the service rendered by these amateurs, for it enables us to correct a transmitter defect which might otherwise go undetected in the transmitter or even at our own receiving stations.

—C. E. Pfautz, Manager
RCA Frequency Bureau

What Good's a Kilowatt?

2068 Escarpa Dr., Los Angeles, Calif.
Editor, *QST*:

Recently I had a QSO with W7FHW, who said my signals were "S9 chirpy." I took off the 250-watt final and used only the 40-watt buffer. He

noticed no difference in strength: still "S9 and chirpy." I took it off and used the 25-watt 6L6G doubler. The signal was still a chirpy S9, only slightly weaker.

Now why should we run a "California kilowatt" when half the soup brings the same S reports. A power limit of 100 watts would have saved me lots of \$\$\$. The only thing I've got against the 100-watt limit is that it would take away one of our rights.

—John T. Chambers, W6NLZ

No DX? Nuts!

911 Boulevard East, Weehawken, N. J.
Editor, *QST*:

It appears that a great many c.w. hams consider 7-Mc. as a glorified 5-meter band. W2's are the worst offenders in this respect, I believe, although I may be biased. It is just a bit discouraging to try to operate on the one-time "snappy" band when two W2's are using full input to QSO across New York City; a good five miles, perhaps. This letter was stimulated by a just finished QSO with CM2BK during the better part of which two of these rather foolish birds jawed at 8 w.p.m. about "no DX on 40 these days, don't even work W9," and more of this aggravating drivel, including "input here 250 watts." Now why in the name of the holy Wouff-Hong use 250 watts to QSO a few thousand yards, QRM fair-to-middling DX, and lob a good sized chunk out of the band—all of which may be done on 160 c.w. or on 5 meters with only a few watts?

The receiver here is an old electron-coupled detector and two-step, yet PY2CW, K5AC, HA4H, etc., are regulars at R3-5, S4-7. Occasionally F3-8, CE3, YV1, SP2, OE1, HK1, HA8, G's all roll in better than S3 and before ten o'clock at night. Now maybe I have the wrong ideas on what "DX" means to these men, but—

To hear all these W's crying "no DX on my new s.s." is beginning to burn me up. Do none of them know how to turn the tuning dial?

—Maynard B. Chenoweth, W2GCC

International Good-Will

430 Baker St., San Francisco, Calif.
Editor, *QST*:

Just finished hearing W9— working VE5—.

What a soap box orator and authority on English, Canadian and United States politics! He was on a 20-meter 'phone with an S9 signal out here, conditions being poor at the time.

If certain foreign and domestic diplomats could have heard him, ham radio would lose no time in hitting the skids.

This would be reformer of Governments certainly did amateur-radio no good by his ravings. Maybe he was slightly inebriated; he certainly sounded like it. Political opinions are necessary in forming the course of any Government, but ham radio is no place for such expressions and comments as done in W9—'s rabid style.

In working ham friends, diplomacy and tact are as necessary, in many cases, as in personal conversations. There is no need to QRM the much crowded bands with such inexcusable and offensive trash as he was putting out. He had the gall to mention the good will between nations due to amateur radio right after he slapped VE5—'s British Government right in the face!

I can't say how it all started (only heard W9—'s side), but he sure finished in fine style. What amateur spirit he must have! I think this sort of thing should stop. If his temper got the best of him to some remark by VE5— (which I doubt) he at least should have been gentlemanly enough to shut up and help keep the U. S. hams' noses clean. Finally, VE5— didn't come back. I wonder why? . . .

—F. D. Rowe, W6FK

He Makes Tubes

72 Avenue Prudent Bols, Brussels (2), Belgium
Editor, QST:

In QST for May, 1937, page 122, there was published an advice telling that W8MEE would like to get in touch with any hams who make their own transmitting tubes. While I have not yet turned out triodes or such like, I have manufactured with some success rectifiers, mercury and high vacuum, with a special kind of heated cathode, and if it is of any help to W8MEE or anyone else, I am at his full disposal to exchange experience.

Thanking you in advance, and wishing the best to old friend QST.

—A. Stainier

About 14-Mc. 'Phone

F. A. de Olmos 17 sur., Apartado (P. O. Box) 815,
Tampico, Tamps., Mexico

Editor, QST:

It was with a great deal of interest that I read the letter published in the June issue of QST under the title of "Foreign Fones."

I am one of those "Foreign Fones" who operate outside of the American 'phone band on 20 meters, and most likely I have or some day am going to spoil a 100 per cent c.w. QSO for the writer of that interesting letter, Mr. Charles W. Finnigan, W2BJQ.

Mr. Finnigan points out the Mexican and South Americans as being particularly guilty of operating outside of the American 'phone band and causing 'phone QRM to the c.w. stations, but he forgets to mention (purposely, perhaps) that the VE's, VK's, PK's, J's, some of the K's and most all of the European hams also operate 'phone outside of the 20-meter American 'phone band. Why then, I ask, does he point out especially the Mexicans and South Americans?

W2BJQ probably ignores the fact that we the Mexicans and South Americans also live in a free country like his. In accordance with the international treaty regulations . . . each country is allowed to assign the use of frequencies within the limits of the amateur bands, so he is entirely mistaken when he states that we deliberately operate outside of the American 'phone band. Yes, we operate there but within the frequencies that have been assigned to us by our own Governments.

Of course we could operate inside of the American band,

too, but who wants to go in there with the big "American kilowatters"? Even Mr. Finnigan himself would feel sorry for us with the low power that we use. What chance in the world would we have of ever making a QSO?

Most of the American 'phones that I listen to are very efficient and sound wonderful. They are very powerful and I admire them, so you can imagine what would happen to my low power sigs inside of their band. They would be an easy bite for the "big sharks." Hi! I guess the rest of the "Foreign Fones" feel that way too.

The American 'phone band is overcrowded as it is, and just suppose that all of the 'phone stations in the world were thrown in there too. What would happen then? What chance would anyone have of ever working a DX station?

I am very sorry indeed that we, the "Foreign Fones," spoil Mr. Finnigan's c.w. QSO's, I sympathize with him; we all feel the same way. Where is the "white dove" that does not grunt and swear when the other guy QRM's his QSO? I would like to find him to send him a nice Mexican souvenir.

The amateur bands are very limited and we hams are too many, so the only thing we can do is to learn and practice the right definition of the word "tolerance".

—R. Villasenor, XE2FC

Radio Poker

4315 Florida St., San Diego, Calif.

Editor, QST:

Probably every ham has heard of playing checkers and chess via radio, but I daresay no one has yet attempted poker over the air.

After several hours of over-taxing my brain (?) in deep concentration, I thought up a practical and simple method by which a nice poker game could be staged via radio, either c.w. or 'phone. With the latter it is easier, but just as much fun can be had with c.w. This system requires a great deal of honesty on each operator's part, but we don't have to worry about that, do we, boys?

Anyone interested in this brainstorm may drop me a line, and I will gladly send the explanation. Perhaps, if the response is great enough, a "Poker Net" may be organized, who knows? It will give the beginners something to do besides sending CQ, test, vvv, "incidentally," "hi hi," and the like. What say, fellers?

—A. Wilson, W6NTF

Harmonic Radiation

Blountstown, Fla.

Editor, QST:

I just been a sittin' back reading over the Correspondence Section of QST (no apologies to W4IR on language), knocking an occasional mosquito off my ear and cussin' the stray dog that's QRming me tryin' to get in the garbage can, when up pops this here W9VZL with his warning against the use of various impedance matching networks for the antenna.

Maybe it's the section of the cigarette I bit off an' swallowed that makes me feel like I do, but I don't think so, as I've felt that same way several times, 'specially when I hear one of them Latin American fellers trying to mouluate a carrier he can't catch. Sounds like ole puss caught in the fly paper an' a-makin' a dyin'-effort to get loose. Nope, I think it's this here harmonic bizness.

The F.C.C. sez harmonic radiation must be as low as the state of the art permits and since W9UZZL has touched on impedance matched antennas I'm going to yank out the next rack in line and see how dang many harmonics I'm generatin'. Naturally we have to generate 'em fore they get into the antenna, so unless we are going to operate the dern thing as a doubler let's get the harmonic generation down and the fundamental up where it belongs.

Here's a coil just as long as will go in the rack, and condensers as small as we can arrange for without payin' extra for them. They're "hittin' the band" with the plates 99 and 98/100 per cent out. The tube voltage is somewhat overrat-

(Continued on page 68)

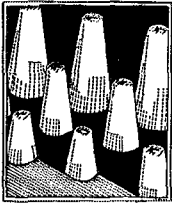

WHEN we first offered a complete line of low-loss dielectrics some years ago, we introduced the use of the word "steatite" to describe a certain group of high quality ceramic materials. At that time the word was used, particularly in Europe, to refer to the best of ceramic dielectrics. In its own field the word had come to have almost the same meaning as "Sterling." Since we first used it, we regret to say that the word has been so abused that it has lost most of its original meaning.

Many people incorrectly suppose that "steatite" is a brand. Actually it is the common name for a certain variety of natural talc used in making the best of electrical ceramics. It is a very expensive material to use because of the difficulties in manufacture. For one thing it is difficult to mold or compact into shape preparatory to firing. Further, it is very fragile at this stage so that breakage is high even when the pieces are handled with the greatest of care. In addition it requires such a high firing temperature that a special kiln is necessary. Only a few such kilns exist in this country.

Because of the difficulties in handling steatite, it is often mixed with other materials to make the product cheaper to manufacture, though inferior electrically. Up to a certain point such adulteration is not objectionable, because for many purposes the loss of electrical characteristics is not serious. However, the practice has been carried to such extremes by some American companies that materials are advertised as made of steatite that actually contain only a trace of that material, the bulk being cheap porcelain. Apparently there is no way to stop this, for as long as there is any steatite in the product at all it is legal to refer to it as "made of steatite."

This applies mostly to this country. In Europe, where most of the pioneer work was done, "steatite" still means quality. In fact they think so highly of the word that in France the principal manufacturer of high-grade ceramics, L'Isolantite S. A., uses *Isolant-Stéatite* as the trade name of their product, while in Germany the premier company is known as *Steatit-Magnesia Aktiengesellschaft*. If these companies should test some of the material sold in this country as steatite, they would be quite embarrassed.

So, what? There is no way to tell what the losses in an insulator are except by testing. At the higher-frequencies — 56 MC, 112 MC and up — dielectric losses become quite appreciable, and a poor insulator is quite capable of stalling a low-powered oscillator. If the oscillator is high-powered enough it will cause very obvious heating of the insulator. Sometimes the heating is so violent that the dielectric practically explodes. In cases like these, of course, there is no mistaking the quality of the material, and one of the easiest ways of testing a piece of doubtful insulation is to expose it to the field of an ultra-high-frequency oscillator.

Barring such a test, the best suggestion we can make is to purchase only from a reliable source, and to be willing to pay a fair price. There is enough competition to insure that you will get exactly what you pay for.

JAMES MILLEN





YAXLEY Cable Connectors

Don't spend minutes of valuable time tracing wiring to find "which wire goes to what" when connecting your receiver to its power supply.

Don't take chances on burning out valuable equipment by making incorrect connections between the chassis of your rack and panel transmitter or P. A. system. Save time and effort when hooking-up your portable equipment.

Use Yaxley Cable Connectors for the instant connecting or disconnecting of any apparatus. The receptacles and plugs are polarized to prevent incorrect insertion.

Available in both 7-wire and 12-wire types, complete with cable or separately as desired. The prices are reasonable. Ask your distributor to show you Yaxley Cable Connectors—or write for details.

P. R. MALLORY & CO., Inc.
INDIANAPOLIS INDIANA

Cable Address—PELMALLO



ing and the bias around three times cut off. Boy, it takes the driving on that to get the proper swing. Harmonics? And how! Just like Uncle Ned's doorstep chillen, 123456789 +.

Seriously, harmonic generation can be brought down to a value that will allow us to use a very efficient matched antenna. Proper design of plate and grid coils with their proper capacities for each band and the use of split-stator condensers will give us the highest practical C. Why carry this L/C too high? Nothing is gained but loss of power in generating harmonics and helping the power company.

Numerous specs of proper L/C coils and capacities are in *QST* from time to time, either the "makem" or "buyem" kind. So why not attack this question in the final stage and not in the antenna, cuz a properly matched antenna will radiate nicely on harmonics.

—J. N. McCaskill, W4CDE

Peace

4415 Norwood Road, Guilford, Baltimore, Md.

Editor, *QST*:

Recently much attention has been given to the furthering of amateur rights in most countries; in the U.S. in respect to more 'phone frequencies. Meanwhile, the prospect of another World War has drawn even nearer. In the event of such a catastrophe, amateur radio in all countries, as in the last war, would certainly be stopped, perhaps permanently. Right now, instead of clamoring for more rights, wouldn't it be more sensible to protect the threatened rights that we already have?

The A.R.R.L., which is more responsible for the world growth of amateur radio than any other factor, and which has protected amateur rights numerous times in the past, should now concentrate its political force on defending amateur radio against the ruining effects of war by working for world friendship and peace. So far it has done very little in this direction. The individual amateur should work for world friendship with foreign amateurs and refuse to allow himself or his station to be used to satisfy the greed of large industrial and commercial interests. The World Friendship Society of Radio Amateurs is an organization which furthers international friendship and peace, and has grown rapidly since its creation over a year ago. (Details from W9DQD.)

The above ideas are almost certain to be attacked by some amateurs and the semi-militaristic organizations of the A.A.R.S. and U.S.N.R. by the use of the words "pacifist" and "unpatriotic." But remember, when you promote or aid in a war against another nation, you are causing the death of people just like their amateurs with whom you have had those excellent DX QSO's.

In these ticklish times, let us all work for the promotion of world peace, based on friendship, upon which depends not only the future of our hobby, but our lives!

—Benson B. Boss, Jr., W3DAZ

Slow Down a Bit

129 Linden Ave., Middletown, N. Y.

Editor, *QST*:

After reading the articles and advertisements in *QST* for several months, I decided something ought to be done about something. . . . Every month you will find in any radio mag dozens of ads and articles urging you to buy or build The-Most-Perfect-Receiver-Ever-Built; if it isn't a super-sniggle-siggle rig it's something even better or its equivalent. I'm getting tired of it. Perhaps you would like to know what kind of a receiver I am using: I have a portable two-tube regen receiver using 30's and she sure does pull in the DX. I can get everything there is to be got.

Another thing—radio magazines are full of towers, articles on the construction of towers, big towers and little towers; towers costing from ten little iron men up. Who wants a tower, anyhow? What's any better than a 30- or 40-foot ash pole? That's what I've got.

I haven't any transmitter on the air yet, but when I do I'll give you a hundred-to-one that it's a pair of tens; and I'll give you the same odds that I'll use a straight key.

Take it easy, ham brethren, amateur radio is getting too darn complicated. Slow down a bit.

Richard L. Kile

THORDARSON

Amateur Specials

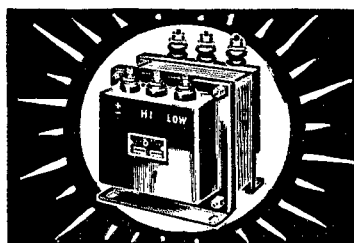
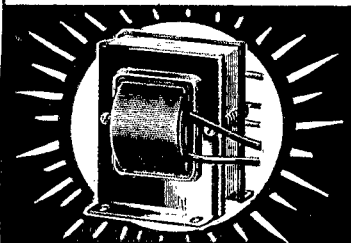

DESIGNED
FOR
AMATEUR
USE

FILAMENT TRANSFORMERS

Open style sub or top panel mounting — 115 volt, 60 cycle primaries.
T-16F08 2.5 volts C. T. @ 5.25 Amps.
Insulation volts 2,000

Amateur Net Price.....90c

T-16F09 2.5 volts C. T. @ 10 Amps.
Insulation volts 2,000

Amateur Net Price.....\$1.05

T-16F10 2.5 volts C. T. @ 10 Amps.
Insulation volts 7,500

Amateur Net Price.....\$1.65

T-16F11 5.25 volts C. T. @ 4 Amps.
Insulation volts 2,000

Amateur Net Price.....\$1.20

T-16F12 5.25 volts C. T. @ 13 Amps.
Insulation volts 2,000

Amateur Net Price.....\$2.10

T-16F17 6.3 volts C. T. @ 3 Amps.
Insulation volts 2,000

Amateur Net Price.....\$1.05

T-16F13 7.5 volts C. T. @ 4 Amps.
Insulation volts 2,000

Amateur Net Price.....\$1.20

T-16F14 7.5 volts C. T. @ 8 Amps.
Insulation volts 2,000

Amateur Net Price.....\$1.95

T-16F15 10 volts C. T. @ 4 Amps.
Insulation volts 2,000

Amateur Net Price.....\$1.80

T-16F16 10 volts C. T. @ 8 Amps.
Insulation volts 2,000

Amateur Net Price.....\$2.40

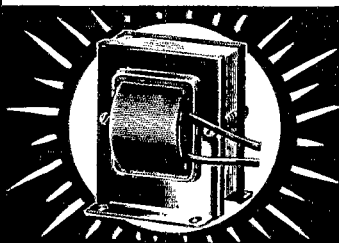

CHOKES INPUT

T-16C20 5-20h — 200 ma — 2000 v ins.
Amateur Net Price.....\$2.25

T-16C21 5-20h — 300 ma — 3000 v ins.
Amateur Net Price.....\$3.00

T-16C22 5-20h — 500 ma — 3000 v ins.
Amateur Net Price.....\$5.40

SMOOTHING

T-16C25 12h — 200 ma — 2000 v ins.
Amateur Net Price.....\$2.25

T-16C26 12h — 300 ma — 3000 v ins.
Amateur Net Price.....\$3.00

T-16C27 12h — 500 ma — 3000 v ins.
Amateur Net Price.....\$5.40

PLATE TRANSFORMERS

Shielded cases — Tapped Primaries
Air Cooled Construction — High
Tension Porcelain Terminals — 115
Volt 60 Cycle Primaries—Rock Bot-
tom Price.

T-16P00 D. C. volts 650 or 500 @ 200
M. A.

Amateur Net Price.....\$3.96

T-16P01 D. C. volts 1250 or 1000 @
300 M. A.

Amateur Net Price.....\$7.80

T-16P02 D. C. volts 1250 or 1000 @
500 M. A.

Amateur Net Price.....\$12.60

T-16P03 D. C. volts 1800 or 1450 @
300 M. A.

Amateur Net Price.....\$11.40

T-16P04 D. C. volts 2500 or 2000 @
300 M. A.

Amateur Net Price.....\$13.95

Your parts distributor is now stocking
Thordarson Amateur Specials. Investiga-
te these stupendous values backed
by the Thordarson guarantee of satis-
faction. Bulletin SD-293 now at your
parts distributor or direct from factory.

★ THORDARSON BRANDED

★ THORDARSON QUALITY

★ THORDARSON GUARANTEED

THORDARSON ELECTRIC MFG. CO.

500 W. HURON ST., CHICAGO, ILL.

Demand "Power by Thordarson"

1937 EDITION

The radio amateur's handbook

THE STANDARD MANUAL OF AMATEUR
RADIO COMMUNICATIONS



PUBLISHED BY THE AMERICAN RADIO RELAY LEAGUE

SPECIAL

JULY AND

Membership
A Year
and the Radio

• ALL FOR
(FOREIGN)

QST and the Handbook — the basis of every radio amateur's library! The Handbook offers you, in its four hundred pages, the permanent information which radio amateurs need — fundamentals, history, constructional data for transmitters, receivers, power supplies, antennas, measuring equipment, everything. QST brings you up-to-date each month with the latest dope on this and that, new developments in circuits and equip-



OFFER

AUGUST ONLY

in the A.R.R.L.,
of QST
Amateur's Handbook

ONLY \$3.00 .
(\$3.75)

ment, and the thrilling, running story of moment-to-moment Amateur Radio. If your QST subscription has several months to run, take advantage of this bargain anyhow — we'll extend your membership and subscription twelve months from its present expiration. Note that this offer applies only if your order is sent direct to A.R.R.L. This special rate, in effect during July and August only, is \$3.00 in U. S. A. proper, \$3.25 in Canada and \$3.75 elsewhere.



Say You Saw It in QST — It Identifies You and Helps QST

(Continued from page 10)

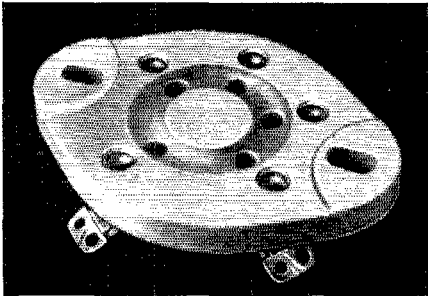
THEY'RE NEW!**JOHNSON WAFER SOCKETS
of ALSIMAG 196**

A real high-frequency development. Makes the ideal ceramic wafer socket for transmitting purposes. Here's why:

- Alsimag 196 material — has approximately $\frac{1}{3}$ to $\frac{1}{10}$ the loss factor of any generally used ceramic.
- As efficient on 5 as on 160.
- Positive spring contacts — recessed in the form — will not turn or twist.
- Permits metal panel mounting without shorting.
- High mechanical strength. Moisture-proof.
- Inexpensive.

Available for all tubes. Ask your Jobber — or write for Bulletin 962

NEW PRICES!

The Famous Johnson 210 "UX" Base
and 211 "50 watt" Sockets

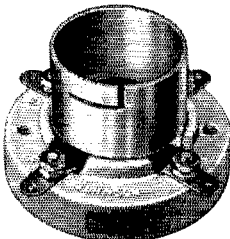
**Now Only****No. 210. List \$.85****No. 211. List \$1.25**

The last excuse for buying substitutes which may look like Johnson's is gone!

E·F·JOHNSON·COMPANY

MANUFACTURERS OF *Radio Transmitting Equipment*
WASECA MINNESOTA U.S.A.

Export Office: 25 Warren St., New York. Cable: "SIMONTRICE"

heard KFI in Los Angeles on the broadcast band. Pitcairn is some 3,500 miles from the United States. With his 12-volt spark coil, aged as it is, he has held two-way communication with ships over distances of 400 miles. While these achievements are not unheard of, still many with modern equipment would be glad to do as well.

One morning when Andrew was aboard the *Yankee*, I was working schedules with the United States and the Canal Zone on high frequency. He had no trouble at all following what was being said even when copying a crack Army operator of the Canal Zone. Also, even though he had never used a tube receiver, he had no difficulty in operating ours (a Sargent Model 12 with plenty of controls). I discovered later that the growth of his surprising knowledge is due to the fact that he absorbs any little hints or remarks dropped by the ship operators he visits when they call at the island.

Many people on Pitcairn understand code; even the young children practice it with reed whistles. I was surprised one day when examining one of these whistles and blowing some code on it to have one of the native women translate it perfectly for me. Because of their ability to operate, any of the islanders have access to the station. While the other operators do not have the technical knowledge or quite the proficiency of Andrew Young, they are all quite capable of holding down PITC. There is another transmitter on the island, a privately-owned, $\frac{1}{4}$ -kilowatt spark station, but this is seldom operated.

In the last few years there have been several stations heard in the amateur bands which have claimed to be on Pitcairn Island. One of these, VR6M, was contacted by G6NJ and heard at W8IGQ. A similar station, VR6AA, was reported in January. Without a doubt these stations are fakes, but who or where I don't know. I hate to deprive any DX hound of the claim to have worked Pitcairn Island, but unless he has contacted one of the few expeditions which have called there, such as WCFT, he is out of luck.

It has often been a dream of mine to find a true Ham's Paradise. Here is the place—no automobile or electrical interference within 1,000 miles, a private prefix, and one of the most remote locations in the world. What ham doesn't dream of setting up a station in just such a place? However, some of the difficulties encountered in PITC would have to be overcome if such a dream station were to come true. Equipment would have to be brought in from the outside and some sort of independent power supply would be necessary. For low power this might be achieved by a wind-driven generator or possibly by a pedal generator such as is used by portable Army outfits. There is no water power available on the island and there is great difficulty in obtaining gasoline. In fact PITC itself in a few years will have to change or go out of existence, because the present equipment is so antiquated that it will be impossible

ANNOUNCING! MODEL "B" TURRET

PAT. APPLIED FOR

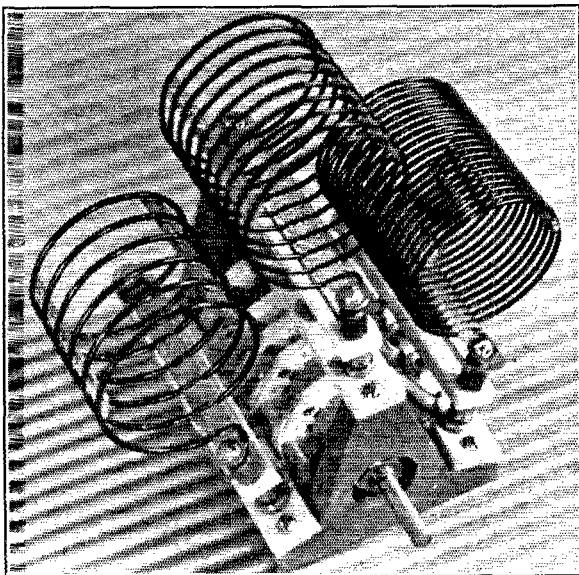

MODEL "B" TURRET, less coils.....\$7.50

FOR

Quick, Efficient Band Switching

Rapid selection of any three bands by positive action wiping contact switch.



The plug-in feature provides a means of selecting any three band combination of coils most desirable at the time of operation.



The Model "B" Turret is equipped with a five section switch, permitting the use of single ended, center tapped, end linked, and center linked **AIR INDUCTORS**.

The Model "B" Turret is not a device forced on the market by competition with similar devices, but is rather the result of two years experimentation and study of the problems involved in efficient, quick band-changing. This Barker & Williamson development overcomes the inefficiencies and pitfalls found in the usual turn shorting and tapped coil systems.

Pretuning of the two lower frequency coils in use by means of small air-padding condensers permits spot frequency operation without retuning on all three bands.

Standard Type B **AIR INDUCTORS** are available for the Model "B" Turret in single ended, center tapped, end linked, or center linked types. Every B & W **AIR INDUCTOR** now comes equipped with genuine Alsimag 196 steatite plug bar.

The Model "B" Turret is designed for operation in exciter stages and final amplifiers where plate voltage does not exceed 1000 volts and with inputs up to 100 watts.

*If your local jobber does not already carry Barker & Williamson **AIR INDUCTORS** have him place your order or write direct to factory for descriptive literature*

W3DGP **BARKER & WILLIAMSON** W3GC

RADIO MANUFACTURING ENGINEERS

ARDMORE, PENNSYLVANIA

Here It Is!

THE Instrument of 1000 Uses

HANDY SIZE

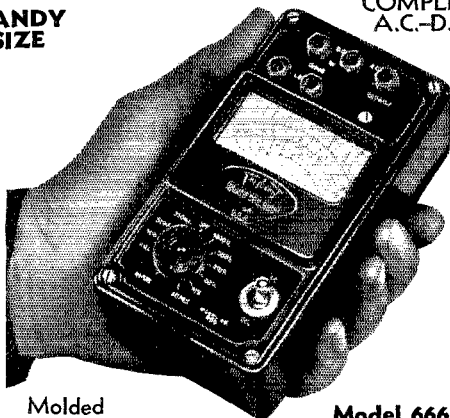

COMPLETE A.C.-D.C.

Molded Case and Panel

Model 666
DEALER NET \$15.00

POCKET VOLT-OHM-MILLIAMMETER

Has 3" Sq. Triplett Rectifier Type Instrument. AC-DC Voltage Scales Read: 10-50-250-500-1000 at 1000 ohms per volt. DC Milliampere Scale Reads: 1-10-50-250. Ohms Scales Read: Low $\frac{1}{2}$ -300; High 250,000. Size — $3\frac{1}{8}$ " x $5\frac{7}{8}$ " x $2\frac{1}{8}$ ". Black Molded Case and Panel Low Loss Selector Switch. Complete with Alligator Clips, Battery and Test Leads.

A complete instrument for all servicing and other needs. Can be used for all AC-DC voltage, current and resistance analyses.

SEE YOUR JOBBER
WRITE FOR CATALOG

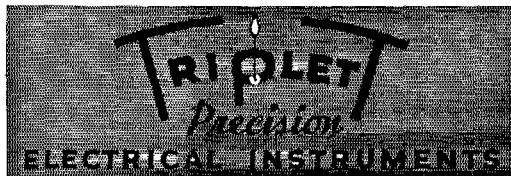

THE TRIPLET ELECTRICAL INSTRUMENT CO.
258 Harmon Avenue, Bluffton, Ohio

Without obligation please send me _____ More information on Model 666. _____ I am also interested in _____

Name.....

Address.....

City..... State.....

to use it with present day ship installations. The increase in A1 tube transmitters on ships will drive the crystal receiver out of use and undoubtedly radio conditions will require the abolition of the spark transmitter.

It is interesting to wonder whether the original mutineers of the *Bounty* when they first took refuge on Pitcairn could ever have had so fantastic a dream as to picture their descendants, 150 years later, operating a radio station to keep the island in contact with the outside world from which they had fled.

What the League Is Doing

(Continued from page 19)

at least six months' experience as a qualified operator on a ship of the United States before he is permitted to be employed as an operator on cargo vessels or tankers upon which only one radio man is required.

Strays

"For many months Ross Hull of the headquarters staff, A.R.R.L., has been recording signals from UHF transmitters trying to unfathom some of the peculiar properties of these frequencies which are not acting according to Hoyle. Remember, theory said waves much below 200 meters wouldn't go very far, but the amateurs discovered they did.

"Now they say that line-of-sight is all you can get out of waves shorter than approximately 10 meters. And yet Ross Hull shows that they, too, bend, and that they show other variations, which theory doesn't account for.

"There is a growing realization that the A.R.R.L. is not only a bunch of brass pounders and potential war-time key punchers. The work of Jim Lamb and of Ross Hull and of many other hams will always stand in the way of those who say the amateurs serve no purpose and that it would be better to turn the ham bands over to cold hard cash uses. And as for the theorists and their deprecating manner toward amateur measurements, let the hams 'smile as we smile now at the old forsaken bough where we cling'."

—An editorial in "Electronics" for June, 1937.

The tube-base pin-numbering system recommended by the Radio Manufacturers Association recently has been changed, thereby making the information given in the receiving chapter in the *Handbook* disagree with the present "RMA Standard." Under the new system the pins are numbered in order in the clockwise direction from the left-hand filament or heater pin, looking at the *bottom* of the tube base or socket. The heater pins are readily identified on all but the five-prong bases because they are heavier than the others. On five-prong bases the heater pins are the middle two of the four grouped around

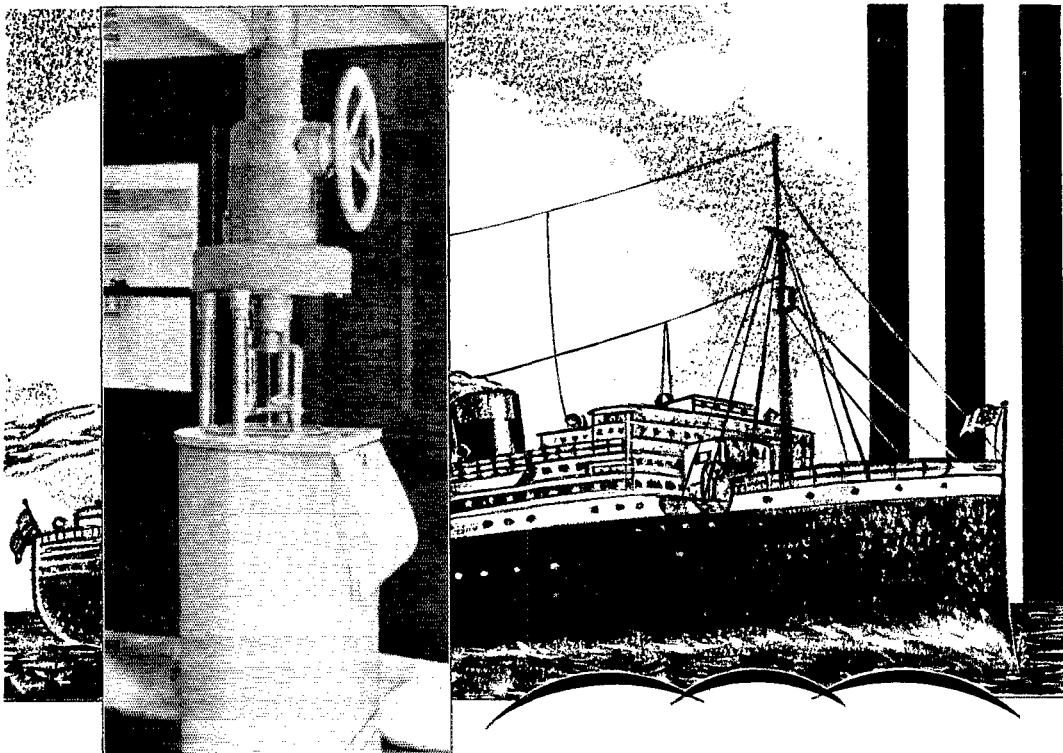

More Dependable Than the Stars!

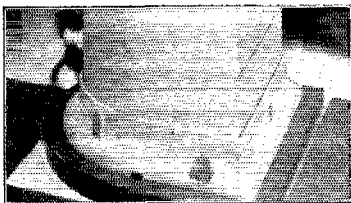

The Direction Finder Keeps
Great Ships on Their Courses

Regardless of weather, modern Radio Marine Corporation's direction finders in the chart rooms of many ships never fail to direct the course. They insure the safety of the cargoes of human life and treasure.

Such a valued device commands the best of equipment, and for its power Burgess Batteries are specified — not because of their intrinsic

value, but because of their value in terms of lives protected.

The plus values in Burgess Batteries will give you, as an amateur or a professional, more than your money's worth — the plus values of consistent, faithful, accurate service.

BURGESS BATTERY COMPANY
Freeport, Illinois

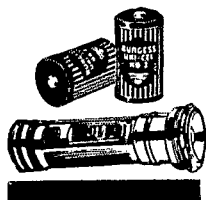

BURGESS



Say You Saw It in QST — It Identifies You and Helps QST

Use
P. R. MALLORY & CO. Inc.
MALLORY
 APPROVED RADIO
 PRECISION PRODUCTS

**Now you can get
 Perfect Portable Power!**

**for Radio Transmitters
 P. A. Systems
 Scientific Apparatus**

P. R. MALLORY & CO. Inc.
**MALLORY
 VIBRAPACK**

Mallory has solved an age old problem for Radio Amateurs and P. A. men—how to obtain economically plate voltage for portable and mobile equipment. The answer is the new Mallory Vibrapack!

The Mallory Vibrapack is compact and dependable. It operates from a 6 volt storage battery—provides outputs of up to 300 volts at 100 m. a. of easily filtered DC. In addition, the low voltage models of the Vibrapacks are ideal for converting 110 volt receivers for 6 volt battery operation.

Made in the following models—

Type	Nominal Output Voltage
551—Self-Rectifying	125-150-175-200
552—Self-Rectifying	225-250-275-300
553—Tube Rectifier	125-150-175-200
554—Tube Rectifier	225-250-275-300

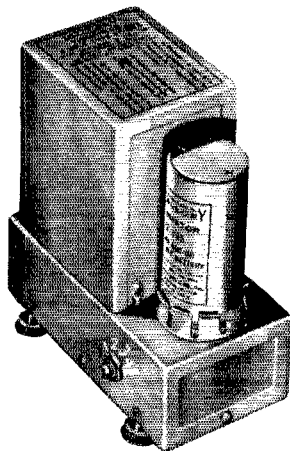

Supplied complete with special design Mallory Long-Life Vibrator. Rectifier tube included with interrupter Models 553 and 554. Average weight only 5½ lbs.

See the Mallory Vibrapack at your most convenient Mallory-Yaxley distributor. He has your Data Sheet, "Perfect Portable Power"—containing complete specifications and operating instructions. Ask for it!

P. R. MALLORY & CO., Inc.
INDIANAPOLIS INDIANA
 Cable Address—PELMALLO

Use
YAXLEY
 APPROVED RADIO
 PRECISION PRODUCTS

half the circumference of the base. As now designated, the left-hand heater or filament pin is always No. 1; the right-hand heater pin will be No. 4, 5, 6 or 7, depending upon whether the base has four, five, six or seven pins. The other pins are numbered consecutively.

Although the change does not affect the usefulness of the *Handbook* tube chart so far as the chart itself is concerned, *Handbook* users should note that the system shown therein is no longer "Standard" and thus avoid confusion when outside references to pin numbers are encountered.

A.R.R.L. QSL Bureau

FOR the convenience of its members, the League maintains a QSL-card forwarding system which operates through volunteer "District QSL Managers" in each of the nine United States and five Canadian districts. In order to secure such foreign cards as may be received for you, send your district manager a standard No. 8 stamped envelope. If you have reason to expect a considerable number of cards, put on an extra stamp so that it has a total of six-cents postage. Your own name and address go in the customary place on the face, and your station call should be printed prominently in the upper left-hand corner.

- W1—J. T. Steiger, W1BGY, 35 Call Street, Willimansett, Mass.
- W2—H. W. Yahnel, W2SN, Lake Ave., Helmetta, N. J.
- W3—R. E. Macomber, W3CZE, 418 10th St., N. W., Washington, D. C.
- W4—B. W. Benning, W4CBY, 520 Whiteford Ave., Atlanta, Ga.
- W5—E. H. Treadaway, W5DKR, 2749 Myrtle St., New Orleans, La.
- W6—D. Cason Mast, W6KHV, 423 East E St., Ontario, Calif.
- W7—Frank E. Pratt, W7DXZ, 5023 So. Ferry St., Tacoma, Wash.
- W8—F. W. Allen, W8GER, 324 Richmond Ave., Dayton, Ohio
- W9—Roy W. McCarty, W9KA, 11 South Michigan Ave., Villa Park, Ill.
- VE1—J. E. Roue, VE1FB, 84 Spring Garden Rd., Halifax, N. S.
- VE2—C. W. Skarstedt, VE2DR, 236 Elm Ave., Westmount, P. Q.
- VE3—Bert Knowles, VE3QB, Lanark, Ont.
- VE4—George Behrends, VE4RO, 186 Oakdean Blvd., St. James, Winnipeg, Manitoba.
- VE5—E. H. Cooper, VE5EC, 2024 Carnarvon St., Victoria, B. C.
- K4—F. McCown, K4RJ, Family Court 7, San-turce, Puerto Rico.
- K5—John J. Carr, K5AV, 78th Pursuit Squadron, Albrook Field, Canal Zone.
- K6—James F. Pa, K6LBH, 1416D Lunalilo St., Honolulu, T. H.
- K7—Leo E. Osterman, K7ENA, Customhouse, Wrangell, Alaska.
- KA—George L. Rickard, KA1GR, P. O. Box 849, Manila, P. I.

YOURS

For The Asking

NEW TAYLOR MANUAL

Brand New! 40 pages — each one is chock-full of modern up-to-the-minute transmitter data. Here are a few of the many features contained in this new Taylor Manual. Photos of chassis layouts, circuit diagrams by the score — new, complete L/C charts — tube characteristics — Class B audio data. Full operating information on the New Taylor Zero Bias Tubes TZ-20 and 203Z. Get your copy NOW from your favorite parts jobber or write to Taylor Tubes direct. The Taylor Manual is well worth a real price tag but it is *FREE* — so don't delay.

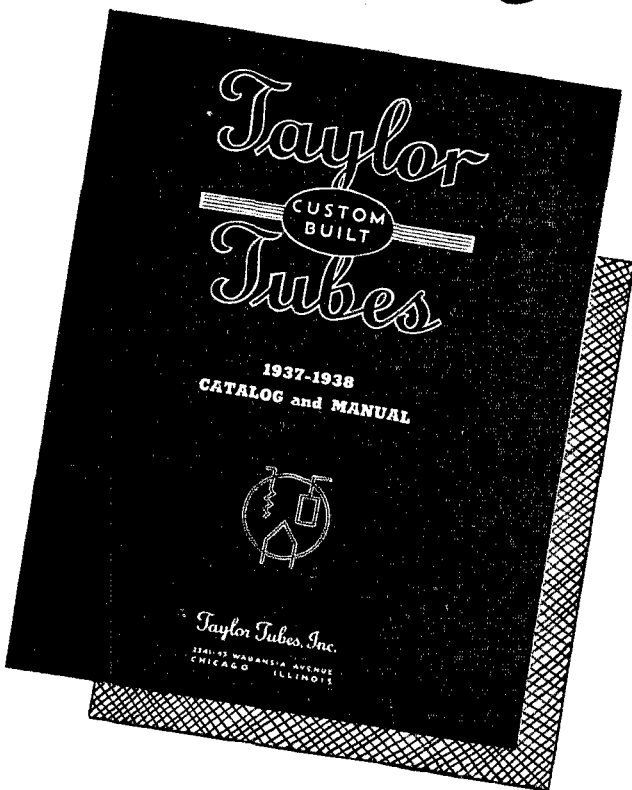

"More Watts Per Dollar"

Taylor HEAVY **CUSTOM BUILT** DUTY Tubes

TAYLOR TUBES, INC., 2341 WABANSIA AVE., CHICAGO, ILLINOIS

STEP BY STEP IT'S

CARDWELL CONDENSERS

IN THE NEW

PROGRESSIVE III

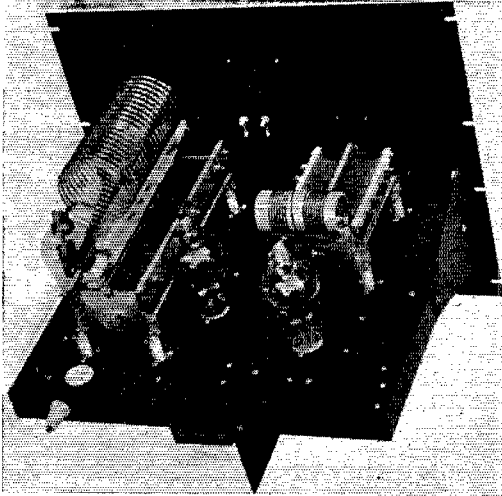

GERRY COLE'S BUFFER-FINAL

Six of the ten CARDWELLS specified in the complete transmitter are efficiently placed to make the most of 450 watts input to the final amplifier.

CARDWELL CONDENSERS USED AND SPECIFIED IN BUFFER-AMPLIFIER

- (1) **XE-240-KD** (shown)Net price each **\$12.60**
- (1) **XT-210-PD** (shown)Net price each **5.22**
- (3) **NA-6-NS** (under chassis). Net Price each **2.16**
- (1) **XT-210-PD** (under chassis) Net Price each **5.22**

IN OSCILLATOR-BUFFER

- (2) **MR-150-BS** (Midway)Net price each **1.89**
- (1) **ZT-30-AS** (Trim-Air)Net price each **1.11**

IN ANTENNA-TUNER

- (1) **XG-110-KS**Net price each **5.82**

And . . . Eleven more CARDWELLS in the 5-10-20 meter Stream-Liner. Ask your dealer about these two up-to-the-minute layouts.

And . . . get your NEW CARDWELL CATALOG No. 40 for latest dope on the new GE Mycalex or Isolantite insulated MIDWAY and STANDARD condensers . . . NOW.

**THE ALLEN D. CARDWELL
MANUFACTURING CORPORATION**
83 PROSPECT STREET, BROOKLYN, NEW YORK

I. A. R. U. News

(Continued from page 54)

Leonard Herscher, W8AYO; Warren W. Anthony, W1BBN; Philip M. Thompson, W6HVV; James F. Pa, K6LBE; Robert S. Grant, W8LDA; Hobart Burkhamer, W8KWI; James Smalley, Jr., VE4GD; D. Cason Maat, W6KHV; George D. Belling, W6CTG; Howard G. Earp, W7CHT; William A. Baker, W6MCQ; Roy Williams, W6JO; H. S. Bradley, W8JTW; G. A. Shoyer, ZS1H; W. H. Browning, ZU6E (phone); S. D. Mann, ZT6Z; Capt. F. C. Elliot-Wilson, ZS6A; J. J. van Ravenswaay, ZU1T (phone); R. L. Varney, G6RV (phone); E. W. V. Butcher, G5AN; Patrick Crisp, G6DX; L. E. Hall-Scholefield, G5SO; E. G. Elliott, G5LI; John H. Payton, G2JB; R. Palmer, G5PP; R. J. Bee, VS2AG; J. F. McGregor, VK2MY; W. N. Chitham, VK4UU; Andre Ferry, F8VS (phone); Georges Lorient, F8XH; A. J. Hilkie, ZL2QT; Charles R. Ambury, ZL2LQ; H. F. W. Day, ZL1DS; Oscar Larson, LA1V; A. Nordgren, SM7UC; J. H. A. Steenmeyer, PK3ST; Don Francisco Aguirre, EA7AK; Antonio Sierra Basurto, Eng., XE1AG; Charles K. Myers, W3EVR; Albert H. Jackson, W1NI; John J. Michales, W3FAR (1st 10-M. WAC); Herbert F. Wareing, W9NY; Paul Anthierens, ON4PA (phone); Capt. F. C. Elliot-Wilson, ZS6A (phone); C. R. Emary, VS6AX; C. W. K. Sands, G5JZ; Paul Meuree, ON4OU; Pierre Coulon, F8QL; Harold J. Rowe, ZL3JA; George Butler, ZL2FA; R. H. Rowe, ZL3GR; Erich Oppermann, D4GAD; Nobuhide Konno, J2MH; Hiroshi Murai, J2MI; Kosuke Matsuda, J2CM; Robert Godefroid, ON4AP; Lucien Bomberault, F3KH; David Ferreira, CT1LC; R. Marschall, D4XR; G. R. Carter, VK3GC; G. L. Templeton, VK3OW; Richard E. Trebilcock, VK3TL; H. V. J. Hutton, VK2HV; D. W. Reed, VK2DR, E. L. Colyer, VK2EL; J. C. Pinnell, VK2ZR; W. M. Manley, VK2MW; R. J. Glassop, VK2RF; F. Tarrant, VK2UF; W. G. Ryan, VK2FI; T. L. Gill, G5GI; Reimar Strich, SM5WZ; Erik Thulin, SM7YE; Ignacio Urquiza, XE1DA; E. Robert Hipkens, W8KKR; Bob S. Heiderstadt, W9RRS; James MacGeorge, W2ICO; Frank Allendorf, W9IGW; Michael Mrvosh, Jr., W8HRD; Salvador Carbonell, K4BRN; Douglas F. Weigel, W1HQJ; Jules F. Obester, W2ALO; E. H. Cooper, VE5EC; Jerzy Lewandowski, SP1BA; Robert C. Harshberger, W9JIE, Francis C. Kramer, W9DEI; Frank G. Rasmussen, W9POV; Richard L. Smith, W4DRD; Banks R. Daubert, W3ERD; Henry W. Culbertson, W6JLZ; Marion G. Brashear, W6LBE; Earl D. Dryer, W9DHN; Ray W. Harmon, W6GHU; Clayton R. Cash, W6LGD; Mrs. Merrill Eidson, W5DQF; Lawrence T. Phelan, W3BPY; F. F. Priest, jr., W3EMM; Lester Lanz, W6HFB; Horace B. Goss, W1AB; Wilbur E. Gustafson, W5DBR; Paul S. LeVan, W3MG; J. Gregg Stephenson, W1DGC; Robert Simmons, W8HFF; F. M. Whitaker, W4OC; Homer H. Richardson, W1AXW; Oscar L. Short, W9RSO; Walter C. Mayer, W8CVU; William H. Bailey, W9FNK; Mrs. Alice R. Bourke, W9DXX; Joseph C. Holt, W5BDW; Andrew Bahlay, W2EIL; Reginald T. Dunlap, W6UD; Fred W. Fiedler, W61PH; Dr. Joseph Lunt, ZT1Q; Walter Wooding, VE1ET; M. A. Lammers, PK1MX (phone); Joseph Bond, HJ3AJH; G. Russell-Lee, G6GL; C. Gregoire, ON4MC; H. W. Tamboer, PA0HT; J. F. Diepstraten, PA0LB; F. J. Versijl, PA0QZ; W. D. J. Baron van der Felts, PA0FF; A. G. Lapworth, G6DL; Hisamaro Kiyooka, J2KQ; I. E. Hill, G6HL; S. W. P. Henton, G5VU; H. Mee, G5MY; Eduardo de Serpa Ferreira, CT1AH; Roger Manil, F8LG; Docteur Pierre Gibert, F8DW; W. K. Carroll, W9UOX; Emil R. Felber, Jr., W9RH; Allen W. Hingle, W2AAL; Charles A. Porter, W2OA; George W. Korper, Jr., W2HMD; Ray C. Baird, Jr., W6HIW; George E. Dammann, W9JO; Forrest D. Drew, W1BJP; C. W. Thyburg, W3DHP; Hoke L. Franciscus, W3EVL; Wayne Connor, W7ESN; Joseph R. Roark, W6JGI; Cammie S. Marie, W3EPR; Julian Mathis, W3DMQ; Roy Johnson, W7DSZ; T. H. Holtby, VE4IG; Arthur L. Ballou, W1DLL; Harold C. Pratt, W1EZ; Herbert S. Riddle, W1DSK; W. M. Bell, W7ADU; Frank Adam, W5EMG; Walter R. Larson, W6LHZ; F. Hideo Murai, K6AKP; Harris F. Tarumoto, K6ESU; Alfred D. Kettenbach, VE4LX; Stuart Foote, W6BAG; W. H. Moloney, W9GRV; Ernest Lippmann, W6JJS; Americo Maragliano, LU4DJJ; J. M. Carstarphen, jr., W4CCH; D. Reginald Tibbetta, W6ITH (phone); Dr. Frank E. Breene, W6FQY (phone); René Cocito, PY2EA; S. Entwisle, G5VN; Øistein Johannessen, LA4K; F. Steinlein, D4NPR; F. C. Clark, ZE1JS (phone); Paul Bonert, D4BME; Capt. S. W. Thorpe, ZS1AH; C. Fenton, G6JZ;

A. C. RELAYS

Made by

Allen-Bradley

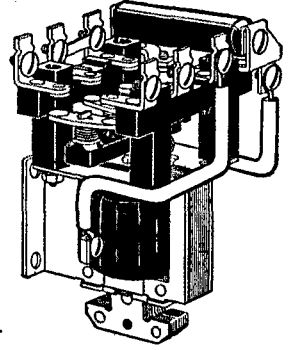
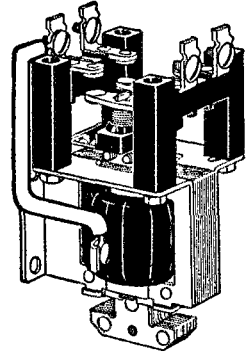

These A. C. solenoid relays are ideal for remote control of transmitters, for control of crystal ovens, and for any general remote control application except for keying. THESE RELAYS WILL NOT OPERATE IN KEYING SERVICE. Silver-to-silver double-break contacts are used throughout.

The maximum contact rating is 10 amp. at 220 v. or 3 amp. at 550 v. The relay coils are wound for 115 volts 60 cycle alternating current. Relays for other voltages can be supplied on special order. Use coupon below.

Type No.	Poles	Nor- mally	Action	Circuit Diagram	Price		Type No.	Poles	Nor- mally	Action	Circuit Diagram	Price	
					Open	In Cab.						Open	In Cab.
A107	1	Open	SP ST		\$3.50	\$4.50	A177	1	Closed	SP ST		\$7.50	\$8.50
A117	1	Closed	SP ST		4.50	5.50	A207	2	Open	DP ST		4.00	5.00
A127	1	Open and Closed	SP DT		5.00	6.00	A217	2	Closed	DP ST		6.00	7.00
A137	1	Open	SP ST		4.00	5.00	A227	2	Open and Closed	DP DT		7.00	8.00
A147	1	Closed	SP ST		5.00	6.00	A237	2	Open	DP ST		4.50	5.50
A157	1	Open and Closed	SP DT		5.50	6.50	A247	2	Closed	DP ST		6.50	7.50
A167	1	Open	SP ST		6.50	7.50	 <p>Radiostat—A stepless graphite compression rheostat for primary of 550 watt filament or plate supply transformer. Range 4 to 150 ohms. Price \$6.50</p>						

ORDER BLANK—MAIL WITH REMITTANCE TO

Allen-Bradley Co., 108 W. Greenfield Ave., Milwaukee, Wis.

Enclosed find money order for \$..... for which please send me, shipping charges prepaid, the following items:

..... for..... Volts..... Cycles

Name.....

Address.....

LICENSED OPERATOR

At the Age of

8

Anyone

Can Learn Code
With the Scientific

CANDLER SYSTEM

Practice Alone Won't Do It!

It's not your fault if you can't get over the "hump" with your code. Without proper mental preparation, it can't be done! CANDLER training is the correct way to learn. That's why it is taught at Harvard College — and produces champions like McElroy and little Jean Hudson. You will be astounded at your *immediate* progress with CANDLER training. Speed and Accuracy will soon be yours.

THREE FAMOUS CANDLER COURSES

Scientific Code Course for Beginners
High Speed Professional Training
Telegraph Touch Typewriting

This may be the turning point in your radio career. Send for the "FREE Book of Facts." Don't deny yourself this wonderful opportunity any longer. Write today!



CANDLER SYSTEM CO.

Dept. Q-8 ASHEVILLE, NO. CAROLINA

MAIL THIS COUPON TODAY!

CANDLER SYSTEM CO.

Dept. Q-8, Asheville, North Carolina, U. S. A.

Send at once the BOOK OF FACTS. This does not obligate me.

NAME

ADDRESS

CITY

STATE

CODE SPEED (if any)..... wpm

Robert W. Sanders, W9LKI; Stephen R. Towne, W1JLE; W. L. Turner, Jr., W3BEK; Louis E. DeLaFleur, W8AU; F. Brooks Herman, W4CBZ; Ross A. Lash, W2CBO; M. P. Mims, W5BDB; Norman Moberg, W7CMO; Walter J. Manning, W7ERA; H. E. Holmberg, W9UBB; Harry M. Matthews, W9UQT; Myron E. Gunn, W8NL; Edward M. Perry, W2GTP; Paul A. Pearson, W7DOX; Lee Baird, W8KNF; Philip B. Williams, W5EIP; George C. Gammell, W4CFD; Daniel C. Blake, W5EZA; Ernest E. Kohler, W7BQX; S. C. Austin, VK6SA; Glenn Rosenberger, W9FFU; James B. Richardson, W1J1Z; William G. Leyland, ZE1JM; Lyle Smithers, W5LW; Preston P. Nibley, W6JVB; Charles P. Zimmerman, W5ERS; Bruce E. Montgomery, W9AHH; Richard H. Kari, W9DHT; Leon Bergren, W9AIW; John I. Stevenon, W8CLS (phone); Francis J. Cady, W8DRJ; H. H. Gosling, H1TG (phone); W. H. Heathote, ZT8X (phone); A. G. Lapworth, G6DL (phone); Antonio J. Restrepo, HK1Z (phone); H. G. Mustermann, W2TP; Hans Eliaeson, SM6WL; Karl G. Smith, W9PRI; F. M. Gray, VK6SU (phone); C. H. Castle, VK5KL; J. H. Lawrence, VK6MZ; E. A. Barbier, VK5MD; R. W. Ross, VK2IG; A. H. Heath, VK8ZX; D. H. Fisher, VK7AB; L. A. Dean, VK5LD; H. Scholz, VK4HR; J. L. Bates, VK4UR; Harold F. Peterson, VK2HP; James L. Young, W7JL; Leslie C. Evans, ZLSAB; Sig. Fortunato Grossi, I1KN; Sig. Enrico Masetti, I1IT; Ernest Mitchell, G5MV; Karl Emden, HB9AX; G. P. Anderson, G2QY; J. H. Cant, G6FU; G. Maciejewski, D4SIG; Frans Herrmann, D4YJI; Herbert Salsbrunn, D4WYG; H. W. Daly, G2VZ; J. Corluy, ON4CD; Roger Van Hee, ON4VH; Ing. C. de Tarjava, Jr., XE20; Alan A. Ramey, W7A00; Charles E. Matthews, W4CYP; Otis Hill, K6AJA; Charles E. Wallace, W1IIB; Ross Hansch, W9RBI; Julius K. Mitchell, W6MPK; William Glenn, W4DCK; George Behrends, VE4RO; D. C. Strawn, W6AXN; Henry S. Conard, W3BQP; Will A. Morain, W1FUY; Hanes S. Carter, W40G; Joseph J. Frekot, W3CHH; Bela Takacs, HAF6C; Frank Roberts, W1AER; Henry Herman, W3EJU; Mark N. Upshur, W3DCG; Stanley McKnight, W9PGN; William Fletcher, W8AF; Norman H. Young, W1HX; Mort R. Miller, W6HEW; N. C. Bauman, W8HXO; Y. S. Mayeda, W6IED; Thomas E. G. Abbott, W5DTJ; Eugene W. Happle, W9SNW; W. A. Kelso, VE1AE; Roger M. Lindley, W8JN; Oscar H. Baker, W9VBQ; R. W. Ellsworth, W6JTB; Lawrence C. Cox, W3BWA; Alex H. Knights, W2DZA; James Jones, W8NUY; Mario Cera, W2IRV; Theodore D. Hale, W1FFO; Henry M. Harris, W6LLQ (phone); Allie L. Hege, W4ABT; Everett H. Gibbs, W8AQ; Kenneth W. Christensen, W6LCZ; Ernest B. Vordermark, W4AZB; Charles H. Thomsen, W5ARO; Arnold N. Dacombe, ZL3GN; W. D. Barnes, ZL2OD; Shigeo Okaya, J3F1; John F. Isaac, G5JJ; Oskar Becker, D4AII; Hans Wottrich, D4DBA; Willi Schulse, D4YLL; H. B. G6rts, PA0GN; H. N. v. Dongen, PA0DE; Ir. W. Keeman, PA0ZK; A. de Jongh, PA0YQ; Antonin Rakous, OK2RS; Miloslav Burda, OK1BM; Josef Namec, OK2MV; Jorgen Berg, OZ2B; S. B. D. Young, G2YY; Robert H. Stoner, W3EPV; Manfred Asson, ES2D; Irving E. Cutting, W1FPP; Juan Lobo y Lobo, XE8N (phone); Charles N. DeRose, W1CND (phone); M. Kouinckz, ON4VK (phone); Frans Polacek, OE1FP; W. Fohy, ZL2LB; Willy Blaschek, OE3WB; G. Hutson, G6GH; W. A. Mead, G5YY; H. Jones, G6ZT; H. A. Dorre, Jr., PK2HD; C. Grundy, G6ZS; P. C. Vis, PA0MQ; N. O. P. A. Nielsen, OZ7ON; Harold L. Hobler, VK4DO; Kenneth G. Bowman, W6IBQ; A. E. Howard, W3BET; Samuel F. Halley, Jr., W9IJW; Ernest B. Adshade, W1GOU; Millard M. Walker, W5AHK (phone); Frank H. Speir, KA1AN (phone); Edward Sauer, Jr., W3FGO; Rob D. Pollock, W9SNP; Vernon B. Cushman, W1GLF; Edwin C. Hutter, W3EXW; J. Gray McAllister, Jr., W4PEY; C. E. Dewell, W9RME; Myrtle V. Hovis, W8GDH; Carl A. Ramsey, W9ELE; Arthur Grant, VE1EP; W. B. White, W6EDY; Arbie Willis, W9NEV; George N. Dugonis, W3COZ; C. S. Jamieson, VE4GE; James J. Valentine, W9UHE; Charles O. Slyfield, W6WQ; Keith C. Daulton, W6EPQ; William T. Gerson, W3CUB; A. B. Unruh, W9AWP; E. Ohrbom, VK3OC (phone); W. H. D. Nightingale, G5NI (phone); George Sinclair, W6GAL (phone); R. S. Cross, G2FZ; Sven Linnfors, SM5YS; T. Inoue, J2LW; Shigetoshi Matsunaga, J8CA; Fritz Peuckert, D8CSC; Hans Moser, D4NVR; K. G. v. Staveren, PA0KG; Ernst Bussmann, D4LDM; W. E. Dunn, G2LR; L. E. Crabbe, G6VF; Asbury P. Walker, W2BMX; Lawrence A. Laser, W3CIC; John McAndrew, W1BLO; Elden U. Benner, W1QH; Ralph Summers, W8OQF; Donald McClenon (Univ.

The LONGEST path is the SHORTEST

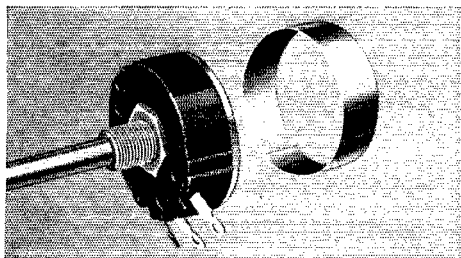

STANDARD RADIOHM

Servicemen
prefer
**Centralab
Controls**

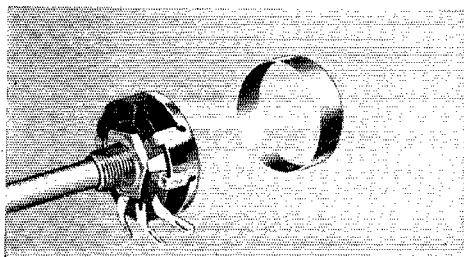

MIDGET RADIOHM

in Centralab Variable Resistors

- Yes . . . the shortest path to good control is a Centralab Variable Resistor . . . for the "wall type" resistor illustrated with each control hugs the inner circumference of the case.
- 1. Maximum resistor length for case diameter.
- 2. Close uniformity between resistors.
- 3. Accurate tapers.
- 4. Uniform current distribution.
- 5. Lower specific resistance and attendant low noise level.
- 6. Better power dissipation.
- 7. Longer life.

Get your
1937 Volume
Control Guide

By all means get your copy —
more listings — more pages —
including '36 and early '37
receivers.

BRITISH CENTRALAB, LTD.
Canterbury Rd., Kilburn
London, N.W. 6, England

FRENCH CENTRALAB CO.
118 Avenue Ledru-Rollin
Paris XI, France

Centralab
DIVISION OF GLOBE UNION, INC.
Milwaukee, Wisconsin

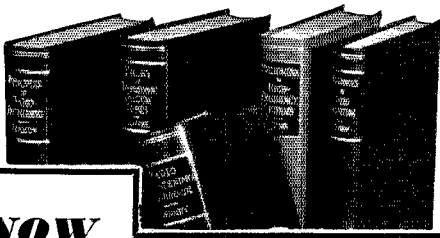

NOW
this high-powered radio
engineering library

sent to you for 10 days' trial —
 at a special price and terms

These books cover circuit phenomena, tube theory, networks, measurements, and other subjects — give specialized treatment of all fields of practical design and application. They are books of recognized position in the literature — books you will refer to and be referred to often. If you are a researcher or experimenter — if your interest in radio is deep-set and based on a real desire to go further in this field — you want these books for the help they give in hundreds of problems throughout the whole field of radio engineering.

RADIO ENGINEERING
LIBRARY

— especially selected by radio specialists of McGraw-Hill publications

— to give most complete, dependable coverage of facts needed by all whose fields are grounded on radio fundamentals

For home-study and reference. Contains a revised selection of books culled from latest McGraw-Hill publications in the radio field.

5 volumes, 3064 pp., 2000 illustrations

1. Glasgow's PRINCIPLES OF RADIO ENGINEERING
2. Terman's MEASUREMENTS IN RADIO ENGINEERING
3. Chaffee's THEORY OF THERMIONIC VACUUM TUBES
4. Hund's PHENOMENA IN HIGH-FREQUENCY SYSTEMS
5. Henney's RADIO ENGINEERING HANDBOOK

Special Low Price and Easy Terms

Bought singly, the five volumes comprising this library would cost you \$25.00. Under this offer you save \$1.50 and, in addition, have the privilege of paying in easy installments beginning with \$2.50, 10 days after receipt of the books, and \$3.00 monthly thereafter. Take advantage of these convenient terms to add them to your library now.

SEND THIS ON-APPROVAL COUPON

McGraw-Hill Book Co., Inc.
 330 W. 42nd St., New York, N. Y.

Send me Radio Engineering Library, 5 vols., for 10 days' examination on approval. In 10 days I will send \$2.50, plus few cents postage, and \$3.00 monthly till \$23.50 is paid, or return books postpaid. (We pay postage on orders accompanied by remittance of first installment.)

Name.....
 Address.....
 City and State.....
 Position.....
 Company..... QST-8-37
 (Books sent on approval in U. S. and Canada only.)

of Md. Rdo. Club), W3EAX; J. A. Casilio, VE5JC; Albert Herrmann, Jr., W9ANQ; Wm. T. Caswell, Jr., W5BB; Frank L. Grover, W1ALW; Jack D. Phelan, W9RSE; Ben F. Holloman, W5ENE; Mart Chaffer, VE3XF; Paul R. Sauer, W3EAH; G. M. Adams, W9OZS; Stanislaw Knebloch, SP1IH; Ks. Dominik Chwojka, SP1FF; R. E. Thornton, W9IYA; Ardenus F. McBride, W1IEO; Harold O. Powell, W3EYT; Dr. A. D. Dudley, W3ADD; Richard C. Dunham, W1EWF; Lorents Arnold Morrow, W9VKF; A. W. Kovatch, W8BYM; Henry L. Blessing, W8JAL; Nathaniel Pfeffer, W2AIM; Raoul Soulie, F8KJ; Marvin H. Thoreau, VE5OT (phone); John D. Kraus, W3JK (phone); A. H. Mason, G6MS; Karel Kaminek, OK1CX; Fernand Mouraux, ON4DM; Chr. Becker, LA3J; Werner Kobold, D3DLC; Rudolf Köhler, D4YBF; Oren B. Gambill, W5EGQ; Louis Merlin, F8NV; B. K. Rowell, G6RL; R. R. Levey, ZU6K; M. F. Long, G2CL; Karl Krüger, D4RVC; Herbert Richter, D4KMG; Karl Worm, D4IZI; Georg Kirner, D4SPP; Robert W. Elton, W4ALJ; Wladyslaw Stefan, SP1BQ; Korpus Kadetów, SP1FI; John E. McMaster, W1ICA; Aldrick C. Krones, W9UIT; Charles H. Dilks, W3AHH; W. I. Korpi, W9HDN; Francis C. Fekel, W3EXB; Harold R. Gebhardt, W8SR; Nelson D. Foley, W8KXK; Alvin E. Martin, W5BIQ; Leno J. Quatramini, W1GNE; D. W. R. McKinley, VE3AU; John C. Erickson, W3DAE; H. M. Keyser, W2GFH; Harry Kuser, W3CWU; Leo W. Knaust, W9TGN; Charles A. Koppe, W8CHO; Merritt Kirchoff, W2FAR; Norol O. Evans, W6LYM; Carl F. McCulloagh, W8LZK; George W. Trook, W8DJJ; John Crawford, W9VPG; Harvey Ashford, W9RGR; J. Glynn Lockner, W8BAI; John P. Sincoc, W9CSI; Wesley Springer, W8JYJ; Reginald R. Cain, Jr., W4CYC; A. Edgar Smith, W8IWI; R. D. Turrell, W8AON; Heppburn Richardson, VE3HT; John E. Wile, W8LAV; Carl T. Lindquist, W6KTH; A. Stützel-Sachs, D3BAN; Brice Anderson, W9PNE; W. G. Leyland, ZE1JM (phone); Joseph A. Robertson, VE2GA; Donald G. Gill, K5AG; Lieut. F. Dinescu, YR5FD; M. Sigmond, PK1MD; J. H. A. Steenmeyer, PK8ST (phone); J. C. Hopman, PK4AU (phone); A. J. ten Cate, PK3MP; Robert Godefroid, ON1AP (phone); C. Reg. Rogers, VE1GR (phone); Hans H. Plisch, OK2AK (phone); Hans H. Plisch, OK2AK; Barton N. Carrick, W6EJC (phone); Ellis L. Butcher, W9DMY; Clement E. deSilvia, VP2CD; Tadeusz Truszkowski, SP1CS; Alexander Trolese, W6IFZ; Bert L. Brown, W6RG; W. H. Foth, W2HDJ; Laurence W. Franklin, W2GRG; Frank J. Lundberg, W7BMB; Captain F. A. Rudolph, K8NCW; Emil F. Malek, W6GVM; Norman J. Drossel, W6CVD; Robert J. Cushing, W1HOU; Richard E. Becker, W5FBQ; William E. Newcomb, W8NDB; Gregg H. McClurg, W8PSG; Donald Bayer, W9SBR; John V. B. Hana, W8HET; Benton White, W4PL; Morgan H. Gravies, W4AG; Clifford J. Fleury, W1ELR; Donald J. Teague, Jr., W8AKI; W. F. McDonald, W9BFB; Herrick Brown, W4ZZ; R. A. F. Farquharson, VS7RF; Emmett Simmons, W5CPT; Roy Crebo, W9VQJ; William H. Schick, W2MU; Hugo A. Bondy, W2CMY; W. K. Fischer, W8FYM; Joseph K. Abronovich, W8ISA; Richard Waldemar Paide, E85C; L. Robert, ON4LZ; Albert Legrand, ON4FQ; Ch. Boulange, ON48S; Jaroslav Ruzek, OK1RU; Ota Kavan, OK2LK; Oldrich Pospisil, OK2PN; Max. B. Buckwell, G5UK; Cyril J. Greenaway, G2LQ; W. E. F. Corsham, G2UV; J. N. Walker, G6JU; J. R. Tuck, G6TD; H. L. Williams, G2KX; J. P. Coveney, G2JX; Rev. L. C. Hodge, G6LH; John P. Male, G6IS; Waldemar Preefer, D8BEN; Willy Schenk, D4AEC; Fritz Falkenburg, D3DBR; Gerhard Bräuer, D4YUM; Wilhelm Schierenbeck, D4AKK; Heins Salitz, D4YFI; Friedrich Kallweit, D3FZI; Ludwig Luther, D4SNP; Werner Mey, D3DXU; Karlheinz Kollmorgen, D4BEC; Jinichi Hoshina, J2IO; J. Horino, J4CT; Masayoshi Nishimaru, J6DK; J. Bakker, PA0JB; Ahlert Eorn, LA2Q; Fr. A. Lovaas, LA5N; Augusto Simoes de Oliveira, CT1OI; B. H. Beukes, ZULX; Yngve Rimbret, SM5VJ; Gunnar Jansson, SM6VX; Marcel Kuns, HB9AI; Edouard Roulin, HB9AY; R. Lutz, HB9BD; Ing. Roberto Ognibene, IILP-I1IR; Ralph G. Kingston, W4DBC (phone); Marcel Dupuis, ON4EY (phone); Georg Kilian, D4VRR; Mr. Schreiber, D4CDM; Kurt Böhm, D4XQF; Max Schultheiss, D4NTR; Th. Boom, PK1MD; Jack Wilson, G6XI; W. Blyth, G5YX; Dr. Hans C. Deckel, D3BMP; A. Pracher, D3CUR; Fritz Sahn, D4MOL; Kristian Nielsen, OZ8A; Ahrent Flensborg, OZ1D; E. Krosgoe, OZ9Q; R. Helbig, D4IUI; Carl Georg Olsen, LA3C; Peter G. Day, G6PD; Heins Engelmann, D4SMO; Loren J. Canino, W8ERZ; Robert M.

(Continued on page 88)

VACUUM **EIMAC** TUBES

3 KILOWATTS INPUT TO THESE EIMAC 100TH TUBES!

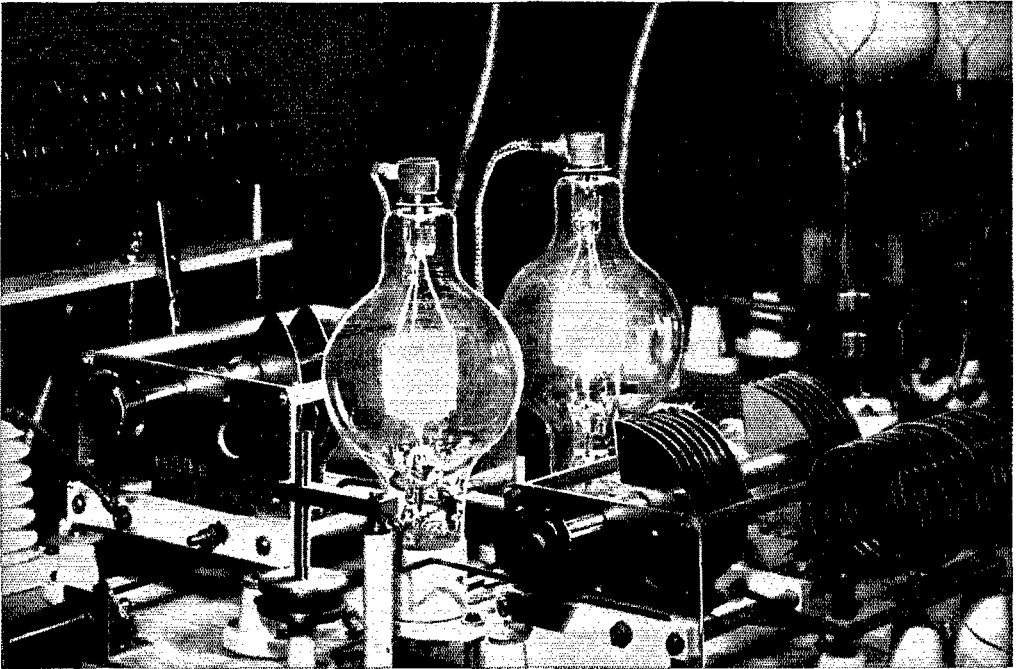

▼ These tubes have been operated with 3000 watts input in a privately owned regularly operated telegraphic transmitter for the past six months. The tubes are still perfect in every respect.

▼ 3000 volts at 1 ampere is the input power. Plate dissipation approximates 500 watts per tube or 5 times its rated value. Plate current is 2.2 times maximum ratings. A "brute force" method of obtaining 2KW of antenna power.

▼ Obviously *we do not recommend* such tremendous overload. But the ability of Eimac tubes to take such punishment gives an idea of the high safety of the Eimac "safe and sane" ratings.

▼ Eimac tubes have this high safety factor because—Eimac tubes have no internal insulators; Eimac tubes have tantalum plates and grids fabricated and exhausted by an exclusive Eimac process; Eimac tubes are completely degassed, no chemical agency or "getter" is necessary or desirable; Eimac tubes have high electrode insulation; a recently developed Eimac process gives Eimac filaments the highest possible thermionic efficiency and long life.

▼ Will the tube you now have or contemplate buying stand even half of the above overload?

PLAY SAFE · BUY EIMAC

EITEL-McCULLOUGH, INC.

San Bruno, California, U. S. A.

WESTERN ELECTRIC

Type 206-AH polarized relay; 5 ohm resistance, S.P.D.T. Special only **97c**

MICROPHONE

transmitting buttons; complete detailed instructions furnished for over 100 experiments. List \$1. Special **16c**

VICTRON "G" — The Magic Insulator of Radio

You've heard enough about it, so no need to describe it.

Thick	6 x 12	6 x 6	1 x 12	Cond. Strips	
3/16"	\$3.60	\$2.00	\$.75	3/4 x 3/16 x 12"	\$.35
1/4"	2.50	1.35	.45	1/2 x 3/4 x 12"	.60
1/16"	1.40	.75	.25		

Q-Max No. 3 R.F. Lacquer 1/4 pint \$1.25 1 pint \$1.75
Q-Max Crystallite Black 1/4 pint \$1.25 1/2 pint \$1.75 1 pint \$1.25

RACK PANELS

by LEEDS

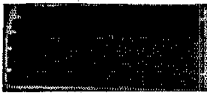

are furnished with black shrivel finish in the standard 19" length, 3/4" thick. Western Electric mounting slots or amateur slotting. Masonite Panels, crystalline black and silver gray in W. E. slotting, 3/4" thick.

Steel	Price	Width	Aluminum	Price	Masonite
PS-1.....	\$.52	1 3/4"	PA-1.....	\$.74	\$.36
PS-2.....	.57	3 1/4"	PA 2.....	1.03	.48
PS 3.....	.68	5 3/4"	PA 3.....	1.30	.54
PS 4.....	.71	7"	PA 4.....	1.55	.69
PS 5.....	.95	8 1/2"	PA 5.....	1.90	.87
PS 6.....	1.15	10 1/2"	PA-6.....	2.45	1.05
PS 7.....	1.30	12 1/4"	PA-7.....	2.90	1.23
PS 8.....	1.50	14"	PA-8.....	3.35	
PS-9.....	1.70	15 3/4"	PA-9.....	3.70	
PS-10.....	1.90	17 1/4"	PA-10.....	4.15	
PS-11.....	2.05	19 1/4"	PA-11.....	4.45	
PS-12.....	2.30	21"	PA-12.....	5.20	

Other sizes — Price on request. Slotting desired in order.

PAWOOD metal punch for drilling holes; we have the following sizes:

3/4" — 1/2" — 1" — 1 1/4" — 1 3/16" — 1 3/4" each. No. 5 heavy duty circle cutter, 1 to 5" dia. No. 4 heavy duty circle cutter, 1 to 4" dia. Extra blades.....24c

EBY CONNECTORS

17 point; complete plug and base; special. **9c**

LEEDS TRANSFORMERS

—high voltage, completely shielded. See July QST for details and prices.

LEEDS CHOKES

Described in July QST or write us for information.

NAVY TYPE TELEGRAPH KEY



List \$3.60. Navy knob—1/4" Tungsten contacts. While they last. **\$1.15** With regular knob.....95c

HEINEMANN Circuit Breaker

In attractive bakelite case, easily mounted on panel. Size 4 1/4" x 2 1/4" x 3 3/4"; single pole, connected in series with primary. 7 models 5 to 35 amp, 115 volt. Special.....\$3.90

LEEDS Copper Wire Specials Enameled

No. 14...40c. No. 12...60c. No. 10...90c. Copperweld steel core enameled. No. 14...65c. No. 12...95c. Phosphor Bronze—hard drawn—stretchless and kinkless; high tensile strength. No. 12...\$1.25. Seven strands No. 20 phosphor bronze...\$1.50 Prices quoted above are in 100-foot lengths. Larger quantities in one piece are available.



LEADS THE FIELD

World Wide Service to Amateurs

45 Vesey Street
New York City

Tel. COntandT 7-2612
Cable Address: "RADLEEDS"

Leeds LD-5. Mounted crystals. Unconditionally guaranteed; cut to your specified frequency in the 40-80 and 160 meter bands at no extra cost. Only.....\$3.50 Money back guarantee if you are not completely satisfied. LEEDS type A.L. metal crystal holder, as illustrated above, fits standard 5-prong socket.....89c

Pyrax strain insulators 3 1/2".....17c
Pyrax strain insulators 7".....69c
Lead in bushings and 15' brass rod...\$1.47
Complete line of Johnson & Birnbach products in stock.

General Radio

Variaes and parts in stock

677-U coil forms, 21 turns, 2 1/4" dia. resonant on 3.5 mc. 100 mfd. cap.....50c
677-Y — 30 turns 4" dia. resonant 1.7 mc. 100 mfd. cap.....75c

NEW G.R. 8-prong socket; heavy contacts separated by a bakelite wall. The ideal socket today. Each 40c, or 10 for \$2.75

A Unit Style Portable Station

(Continued from page 26)

has been incorporated in the general layout.

The modulator, built up in the same size cabinet as the transmitter and receiver units, is entirely conventional in layout. It uses a 6N7 twin triode in Class-B, delivering 8 to 10 watts at reasonable distortion levels. This is not sufficient to fully modulate the 6L6's at 35 watts input, of course, but the resulting signal seems more effective than the average 20-watt input portable when the latter is properly modulated. This is presumably due to the heavier carrier, an asset in reducing adjacent-channel interference on receivers with a.v.c. Too, the use of a low percentage of modulation with consequent minimization of r.f. distortion seems to permit higher levels of audio distortion without serious maltreatment of the voice quality. Total harmonic distortion of 10 or 15 per cent is not noticeable on the ordinary receiver of limited frequency-response with this arrangement. Despite the fact that an oscillator is being modulated, there is no detectable frequency modulation at the available percentage.

The driver tube is a 6C5, operated directly from an inexpensive high-output double-button microphone (Shure 3B). To those who have come to look with disdain on "carbon mike" quality the result is surprising in the degree of naturalness and articulation achieved. The unaccustomed hiss is disturbing at first, but it is not at all a considerable factor.

One control enables adjustment of the voltage applied across the microphone, while another sets gain. If a.c. operation of the modulator is contemplated provision can be made for plugging in a couple of flashlight cells for mike supply.

Vibrator-Type Plate Supplies

(Continued from page 58)

transformer, and r.f. filter for the elimination of "hash," but does not include the conventional smoothing filter. This leaves the way open for the builder to use as much or as little filter as may be necessary for transmitting purposes. Ordinarily a single pi-section filter, with the usual double-section electrolytic and small choke, will be ample. The efficiency of the unit is quite high; for a power output (at the filter input) of 32.5 watts the power taken from the battery is about 46 watts, or an efficiency of approximately 70%. The battery drain at full output is slightly over 7 amperes, and is almost directly proportional to the plate current drawn plus an "idling" battery current of about 1/2 ampere.

Two models are supplied for applications where the -B lead cannot be grounded, which is the case when the power pack is used with certain types of receivers; these use rectifier tubes. In other respects, the ratings are the same as those of the self-rectifying types.

With the amount of filter ordinarily used with the conventional line-operated power supplies, the Vibrapack is applicable to receivers as well as transmitters. Vibrapacks are manufactured by P. R. Mallory & Co., Inc., Indianapolis, Ind.

EXTRA

Newark News

EXTRA

Vol. 1

CHICAGO, ILLINOIS, JULY 16, 1937

No. 1

SETS AND PARTS ON EASY TERMS BARGAIN-BUYING OPPORTUNITY FOR HAMS

NEWARK APPOINTED Graybar Agents for WESTERN ELECTRIC

Amateur Broadcasting Equipment

- 300-A. Class A audio, 12 1/2 watt output..... \$10.10
- 304-B. Ideal ultra high frequency triode..... 12.50
- 305-A. 85 watt screen grid U. H. F..... 38.50
- 306-A. R.F. pentode — the perfect frequency multiplier.. 10.80
- 307-A. A.F. and R.F. pentode..... 13.65
- 316-A. Ultra high frequency triode, 7 1/2 w. output on 500 MC..... 10.50
- 242-C. 100 w. general purpose..... 15.00

- 633-A. "Salt Shaker" Dynamic mike, broadcast quality at the new low price of..... 42.50
 - 1002-C. Phones..... 8.30
- Full technical catalogs available on each type tube upon request.

NEW TAYLOR TUBES IN STOCK !
TZ-20. \$2.45; 203-Z. \$8.50 !

VERY SPECIAL Oil Filled and Oil Impregnated FILTER CONDENSERS

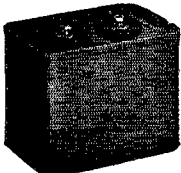

Lucky purchase of 10,000 all well known makes enables us to offer astonishing low prices. All Guaranteed at rated voltages. Already sold down to limited supply and going fast.

- Order Now!*
- 1 mfd., 2000 V. DC, 5 x 3 1/2 x 1. 1 1/4 lbs..... \$1.25
 - 2 mfd., 2000 V. DC, 4 7/8 x 3 1/4 x 1 1/2 lbs..... 1.50
 - 8 mfd., 2000 V. DC, 5 x 3 1/2 x 2 1/4 lbs..... 2.75
 - 9 mfd., 3000 V. DC, 5 1/4 x 3 1/2 x 11. 9 lbs..... 7.25
 - (Including 2 1/2 Bakelite Standoffs)
 - 4.4 mfd., 1500 V. DC, 5 x 3 1/2 x 1 1/2 lbs..... 1.75
 - 5 mfd., 1500 V. DC, 3 3/4 x 3 1/2 x 1 1/2 lbs..... 1.90
 - 5.2 mfd., 1500 V. DC, 3 x 3 1/2 x 2 1/4, 2 1/4 lbs..... 2.00

BASSETT Concentric Feeder

The BCF-50 is a complete concentric feed system with end seal and leads brought out through the seal for soldering to the center of a doublet half-wave antenna.

- BCF — 50 ft..... \$9.75
- BCF — 75 ft..... 12.75
- BCF — 100 ft..... 16.75

ORDER NOW

Easy terms on orders for parts, sets and tubes \$60.00 or more. We have all the new amateur sets as soon as released by manufacturers, on our convenient 6% Credit Plan. No matter what set you want, we can furnish it. All the standard makes in stock for immediate delivery. Before you buy, WRITE US.

Brand New Line Thordarson Plate Transformers NEVER BEFORE ADVERTISED

*Specially Designed
for Amateurs*

Fully shielded — air cooled construction — tapped primaries — porcelain terminals.

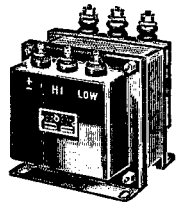

No.	DC. Volts	DC. MA.	Size	Net Price
T-16P00.	500/600	200	3 1/2" x 4" x 5 1/2"	\$3.88
T-16P01.	1000/1250	300	5 1/2" x 7 1/4" x 7 1/2"	7.64
T-16P02.	1000/1250	500	6 1/2" x 7 1/4" x 8"	12.35
T-16P03.	1450/1800	300	6 1/2" x 6 1/2" x 8"	11.17
T-16P04.	2000/2500	300	6 1/2" x 8" x 8"	13.67

THORDARSON TRANSFORMERS

Multi-match modulation with plug-in jack terminals. Completely compound filled.

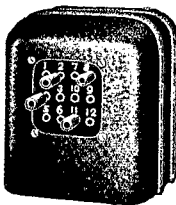

- T-11M74 — Will handle any power tubes to modulate a 20 to 80 Watt Class C Stage. Maximum audio output 40 Watts. 4 1/2" x 4 1/2" x 4 1/2" High. \$4.70
- T-11M75 — Will handle any power tubes to modulate a 40 to 150 Watt Class C Stage. Maximum audio output 75 Watts. 4 1/2" x 5" x 4 1/2" High. \$7.35
- T-11M76 — Will handle any power tubes to modulate a 100 to 250 Watt Class C Stage. Maximum audio output 125 Watts. 5 1/2" x 5 1/2" x 6" High \$11.47
- T-11M77 — Will handle any power tubes to modulate a 200 to 600 Watt Class C Stage. Maximum audio output 300 Watts. 6 1/2" x 6 1/2" x 7 1/4" High. \$17.64
- T-11M78 — Will handle any power tubes to modulate a 450 Watt to 1 KW. Class C Stage. Maximum audio output 500 Watts. 7 1/2" x 7 1/2" x 8 1/4" High..... \$35.28

Thordarson No. T6878 Plate and Filament Transformer, 600-0-600 V. at 200 MA. 2 1/2 V. at 10 amp. 5 V. at 3 amp. 7 1/2 V. at 3 amp. \$2.45

Thordarson Transformers 115 V. — 60 Cycle 400-0-400 — 200 MA. 6.3 V. — 5 amp. C.T. 5 V. — 3 amp. Electrostatic Shield Fully Shielded..... \$2.95

FILAMENT TRANSFORMERS

If you like to save money on quality merchandise here's some real bargains.

- 2.5 Volts, 10 Amps. — 2500 Volts Insulation — No. 2510 ..\$0.95
- 5 Volts, 4 Amps. — 1600 Volts Insulation — No. 50S...\$0.95
- 6.3 Volts, 3 Amps. — 1600 Volts Insulation — No. 63S...\$0.95
- 7.5 Volts, 3 Amps. — 1600 Volts Insulation — No. 75S...\$0.95

CHOKES

- 18 Henries, 125 M.A..... \$1.15
- A real quality choke. Resistance 130 Ohms. No. NS115..... \$1.15
- Thordarson No. T6877 Heavy Duty Choke. 15 henries at 250 MA..... \$1.95

NEWARK ELECTRIC COMPANY 226 W. MADISON ST. Dept. Q CHICAGO, ILL.

(Continued from page 68)

ing his 700 watt, 110 volt a.c. rewound Dodge generator. WZ and PZ are to be congratulated on their success in re-winding 2,000 volt, one amp. D.C. job into 110 volt, 60 cycle a.c. plant. ADY is rewinding a 220 volt, d.c. 10 kw. generator. GD and KX made their W.A.C. on 'phone. EA reaps harvest of S.W.L. cards from England. QX is putting T20's in final! AGZ will be on with 6L6 and '46. AEN is rebuilding. ADD is working for CJCA. LQ's 1.75 Mc. 'phone is still holding up well. IN acquired new freq-meter. KK is putting '03A on 1.75 Mc. ZW is grid modulating a 211E. WX spent his holidays at the coast visiting 7FBC. The Edmonton gang has been working hard on the preparations for the Alberta Hamfest and by all indications it will be bigger and better than ever. AFT operated portable on A.R.R.L. Field Day in conjunction with ABC, NF, AFG and TY.

Traffic: VE4AFT 15 GE 11 LQ 8 SW 7 EO 3 LX 2.

PRAIRIE DIVISION

MANITOBA—SCM, A. J. R. Simpson, VE4BG— Along with AAW on 3.5 Mc. we have NW and KY working c.w. and AG with his Class B 'phone. EK added a new bullet microphone to his rig. IC expects to leave Winnipeg for Vancouver and thence will probably go to England to take up new work in the radio field. IP is vacationing in California. KX expects to install one of the new Hallicrafter jobs. MY is building a new receiver with all the gadgets. TO is now a proficient 14 Mc. 'phone station. ZV leaves for a vacation down south. 56 Mc. history around these parts was created when ZU and SR were able to work across Lake Winnipeg from Winnipeg Beach to Grand Beach. MW is back in the North Country at a new operating post. VE3CG was a visitor to Winnipeg. GC is working 56 Mc. portable during the summer. UX keeps in regular contact with Winnipeg on 14 Mc. Gas is \$3.00 per gallon where he is located so QSO's are not any longer than necessary. ZK finds the early morning ideal for working the rig these days. AEC has a new Hallicrafter receiver. RO is now the proud father of a junior YL operator.

Traffic: VE4AAW 29.

SASKATCHEWAN—SCM, Wilfred Skaife, VE4EL— Another Hamfest has come and gone. We had a big crowd, a nice banquet and a general good time all around. Each Club in the Section should study each 'Fest their members attend. There is much to be learned as each 'Fest has some good points and some which are not so good; if therefore, each Club will give these some thought and plan their contribution for the next year, we should get a 'Fest which will promote the best in every respect in Amateur Radio. OP is changing QTH. OM is again on 14 Mc. LV is trying his luck again. SY is now using PR-15. 4JV has HF100 final. ZC is trying a T55. AIE is a new ham. Welcome, OM. ABI is looking for a T20. PG has gone to the Pacific Coast. Mr. & Mrs. IG have also gone to the Coast and a nice farewell party was given in their honor at Mr. & Mrs. OM's home. KJ had trouble when tritetting but finally doubled successfully by shielding plate coil. ES and ML are getting out well on 14 Mc. 'phone. BD with about 180 watts making good DX contacts. UK with 20 watts gets very good responses. XM will be on at old QTH soon. JB brought back a T55 from the 'Fest. QZ blew himself to a 7 Mc. quartz plate with the proceeds of 5th place in the VE/W contest. RJ is putting his 3.9 'phone on 14 Mc. for the summer. TW put in T20 as buffer to a T55 with big increase in excitation. PQ is developing cauliflower ears from hauling traffic through summer static. XB is working on new superhet. UD is using two 6L6's. MB is back after wintering among the Calif. kilowatts. TN has completed FB 56 Mc. long lines osc. and is working UD and PQ with good success.

Traffic: VE4PQ 30 QZ 21 UL 10 EL 6.

NEW ENGLAND DIVISION

CONNECTICUT—Frederick Ells, Jr., W1CTI—AW closed down evening operations July 1st. New broadcast schedule is 1 P.M. E.D.S.T. daily except Saturday and Sunday. JXP is working with JFN on a 56-Mc. net. IMV has a new mast and antenna and is trying 14-Mc. 'phone. JTD is being revamped. ES has new transmitter on the air. KJP had his rig on exhibition at high school. JGO (ex-W7JT) of Manchester is now 60TE in Inglewood, Calif. EH installed new transmitter March 12th; in 60 days of operating he made 193 QSO's, 113 foreign, 80 W/VE.

Traffic: W1AW 242 JXP 83 JYE 68 JQD 60 KFN 59 BDI 48 IMV 16 JTD 10 ES 8 JFN 7 GKM 4 JYL-CBA 2 KJP 1.

MAINE—SCM, Winfield A. Ramsdell, W1FBJ—The S.C.M. wishes to thank all the gang for the splendid support in the recent election. Hope that support continues, now the election is over. GOJ reports P.T.N. closed until fall. TE is contemplating some 3.9- and 14-Mc. 'phone work. JAA has a very nice signal on 3.5 Mc. HZJ applied for O.R.S. Applications very welcome for O.P.S., O.R.S., etc. What say, gang? CZ is still trying to make himself heard in Portland on 3.9-Mc. 'phone. KOH has FB portable rig, and has already made contact with home from Moosehead. The Portland Amateur Wireless Ass'n is still holding weekly meetings. All hams are cordially invited to drop in if in Portland any Tuesday night. Farming is taking all of DOZ's attention. A Sky Challenger adorns the operating desk at GVS. Red pint is the latest for transmitters according to MN. IST is remodeling the rig, getting ready for more excellent traffic totals in the fall. APR and INW are about to take the fatal plunge—Matrimony. Fine new rig at EWN's place with 35T's in final. FNB and JIN are having fine time on 1.75-Mc. 'phone. BGU made the A.P. news recently when he took unto himself a bride who has been signing VE1EH. Best of luck, Stony and Doris! DX is still the order of things with CPT. EF was recent caller, and while in Portland fixed up enlistment in N.C.R. FBJ is on 3638.5 and 3918 kc. Mail reports and news to 12 Kensington St., Portland. CRP is getting ready to get back at the key again and will be after O.R.S. renewal very soon. AZZ, IRR, ABQ, VV, E1Y, GGS, GVS, GJY and ATO are some of the Portland gang working on 56 Mc. Would like to hear from all the clubs and stations in the State with dope on activities, rigs and other news so that this report will be more interesting. 73.

Traffic: W1GOJ 57 INW 41.

EASTERN MASSACHUSETTS—SCM, Albert N. Giddis, W1ABG—AKS says the 7-Mc. net is coming along fine. JNF is now S.N.C.S. for E. Mass. A.A.R.S. 7-Mc. net. HWE had his YF make up and send in his report. FB. ABG wonders if there is any such thing as "remote modulation"; . . . S.W.L.'s still compliment him on his FB 'phone which he hasn't used for six years! HKY worked a few new countries. JZU contacted his fortieth state. JZN is now an O.B.S. INA, JNF, JTM and JZU are new O.R.S. JYJ and JZU now have Net crystals. FAR is rebuilding around a W.E. 276A. QA is at Salisbury for the summer. HHR is working 3.5-Mc. portable at Nahant. WV clicked off his 95th country. HIL deplores bootlegging of his call. QW, KB, IZE, JNF, IUI, NH (portable), HRF, KBQ (port.), HCH and NF did a good job in providing communication for a Lawrence to Salisbury Beach marathon on Memorial Day; 56 Mc. was used completely. BLO got an S5-6 report from G2PU while using $\frac{3}{4}$ of a watt input; he was using 50 volts at 15 m.a.; he finds such work more interesting than high power. The S.S.A.R.C. elected new officers as follows: Pres., EAU; 1st Vice-Pres., AKY; 2nd Vice-Pres., HRF; Treas., FVD; Secy., ALP. The M.V.A.R.C. combined its annual outing with the A.R.R.L. Field Day. ABI is going on 28 and 56 Mc. for the summer. JTM is using 7 Mc. at new QTH.

Traffic: W1AKS 425 (W1GO 157) IHI 371 JCK 249 JNF 209 INA 200 AMT 170 AGX 153 HWE 134 IWC 130 ABG 111 BEF 34 IUQ 25 BMW 22 HKY-JZU 10 JYJ 12 RE 4 IVX 3 ASI 24 CIK (CEIC 8). (Apr.-May W1JZU 10).

WESTERN MASSACHUSETTS—SCM, William J. Barrett, W1JAH—Among those seen at the N. E. Division Convention were: BVR, DDK, IOT, IOR, EOB, JJR, JAD, FFK, COI, KER, ZB, BSJ, and GZL. AJ has resumed schedule with NY1AA. IPK sold 56-Mc. rig to IJT. R.M. IOR sends the dope on the Worcester gang: JNA is radio-man on shakedown cruise of U.S.S. *Vincennes* in European waters; DDK has new portable-mobile a.c.-d.c. rig. That's the spirit, Fred; IDG moved to Delaware, and is succeeded as president of Worcester Radio Ass'n by CFQ; ZJ runs a ham-shack picture each Sunday in his newspaper radio column; KOQ is new ham in Leominster; IOC is threatening to use that big bottle he has laying around the shack; IEK and DIE are ashore again; IOR is building 616G-805 rig for next traffic season. The Hoosac Valley Radio Club operated portable from machine-gun range of local National Guard Co. in Field Day with separate rigs and receivers on 3.5, 7 and 56 Mc. BVR and his mother visited the JAH's. BKG is concentrating on 56 Mc. for the summer. ZB schedules WCFT, 81UF, 9ERO, 1FTR. AVK represented the Western Mass. Amateur Radio Club at an emergency communication meeting of the Springfield City Council on flood control; see AVK or BPN for further details.

Traffic: W10R 45 IOT 30 BVR 26 (WLG 132) AJ 13 JAH 11 ISN 8 IZW 1 ZB 128.

NEW HAMPSHIRE—SCM, Carl B. Evans, WIBFT—The M.V.A.R.A. enjoyed an FB outing on the A.R.R.L. official June Field Day with a portable location on Silver Lake in Belmont, N. H. Two receivers and transmitters were kept on the air continuously by BFT, FAB, IVU, JCA and JBA. GKE, HOV, JJD and JKH visited at times and helped keep things humming. The club wishes to thank AVJ, FTJ, HOU and JGC for the loan of equipment that helped make the field day a success. A total of 80 contacts with a score of 1070 points was the result. 6KNO is staying in Boscawen for the summer. IP is active on 56 Mc. for the summer. AUY reports the N.E.D.R.A. off the air until October 3rd. COO is operating with crystal control on 60 Mc. with 200 watts input from Barrington. HGV and KIN are new O.R.S. CME is back on the air after recovering from sickness this winter. JQX is operating portable from Stratham Hill Fire Tower on 56 Mc.

Traffic: W1P 93 HGV 28 BFT 21 KIN 6.

RHODE ISLAND—SCM, Clayton C. Gordon, W1HRC—IQF has moved to Wickford. BJA has been building portable equipment. IAV graduated from St. George's and is going to Nantucket for the summer. BVI, JH, HPE, JFF and JNO are on 56 Mc., with JFF getting rating from JNO as R.L.'s best 56-Mc. 'phone portable. JNO took 1st Class Radio Telephone and 2nd Class Radiotelegraph examinations. The Providence Radio Association participated in the Annual Field Day with GTN, HRC, IEG, JXA, JEZ, JXQ, JUE, JDX, FAH and DAH out with portable equipment at DAH-FAH's "estate" in Scituate for location. BIT is transceiving in car—with 30-mile record. Galilea to Scituate, as best work—using 42-42. It is reported WIAQ made out OK with the Convention, which is good news—congratulations, boys. HXS has his 56-Mc. rig working at Bristol Highlands again this summer. BCR is doing good 56-Mc. work from Scituate. IZO rebuilt Ford generator for 110 a.c. for portable work. CAB has new QTH. IPU is with Dental Supply Laboratory in Pawtucket.

Traffic: W1ZO 37 JNO 8 GTN 6 IEG 5 (WLGK 60).

VERMONT—SCM, Alvin H. Battison, W1GNF—C.R.M.: 1FSV. R.M.: 1EZ. P.A.M.: 1AVP. IRO has moved to a new QTH. IOA visited at GNF and AHN. AVP's YF is fast learning the code. ATZ is using ELJ's transmitter on 1.9-Mc. 'phone. FN has erected the "ideal" 14-Mc. radiator and is contacting numerous VK's on 'phone. GAE and GAN are going to take their commercial examinations soon. ELR is employed at the Oleott Falls power station in Wilder. KJG is planning a Vt. State Hamfest. BJP has some fine photos of his new transmitter. IQG and JHK visited at GNF. GUN is working for Montgomery Ward. IDW finds 14-Mc. 'phone very interesting.

Traffic: W1GAE 26 AVP 25 FSV 18 GNF 7 AHN 2.

ROANOKE DIVISION

NORTH CAROLINA—SCM, H. S. Carter, W40Q—Mt. Holly: CYY has worked all continents. Kings Mountain: DOZ is working plenty of DX on 14 Mc. DOQ has his rig on 14 Mc. after a month of hard labor. DOV has W.A.S. and is waiting for card from Asia for W.A.C. CEI is building a 1-kw. rig for EOO. CEI and CE are building a portable rig 'phone and c.w., c.c. Siler City: QI is working on 3.9- and 14-Mc. 'phone. Hickory: EMV had a neon bulb near his tank coil, and burned a hole in the bulb. Goldsboro: ESO is a new ham, and is on 7 Mc. with about 25 watts input. Oxford: ETZ and ECH are members of National Guard and are going to the summer encampment at Jackson, S. C. Greensboro: DZS has applied for O.R.S. MR is on 14 Mc. most of the time. Raleigh: EG is experimenting with power supply bias for his kw. rig. BUE got a job with G.E. after graduating from State College. JB is slowly getting his rig built up again. ANU says his RME69 is a "honey." CGL has a 45-foot mast on top of his garage. HV had an automobile accident, but is able to be out again. Mr. Foley from R. L.'s office was a visitor at the Raleigh Radio Club. Wilmington: FT sticks to 28 Mc. EC has been very active on 14-Mc. 'phone. BPL is taking up amateur photography for a hobby. BTR is playing in an orchestra. BQZ has a pair of T-200's. BJV has been using the r.f. part of the rig until he finishes his modulator. NY is considering building a superhet. CPT has had very little time for radio as his mother suffered a nervous breakdown and heart attack, and he has spent most of his time with her. We all hope your mother soon recovers, OM. Winston-Salem: BYA spends

about 70 per cent of his time experimenting, and wants a 56-Mc. net in Winston-Salem; he says his rig can be heard 7 or 8 miles. DGV is working quite a bit on 14 Mc.; among his DX is E15QX, YV5AG and VP6PZ. DWB is working portable at Marion, Va., for the summer. W4NC had a very fine Field-Day outing on top of Hanging Rock Mountain with about 21 hams attending. RA received his W.A.C. CFR received a certificate as W/Ve Contest winner.

Traffic: W4DW 85 ABT 26 NC 10 CVQ 8 DWB 6 MR 2 DGV 1.

VIRGINIA—SCM, Charles M. Waff, Jr., W3UVA—GKB will attend Navy Radio Material School. DWB operates 14-Mc. 'phone. EXQ needs Asia for W.A.C.; he has 25 countries. GTS was visited by UVA. BFW is rebuilding. CSY has made W.A.C. twice since January with a 35-T final. FMY is new O.P.S. UVA now has 76 countries. FBL is rebuilding for 'phone. EMA is taking Virginia bar exam. BSY and EZL are back in Charlottesville. Note new address of the S.C.M. in front of QST. Send all future reports to that address. FKD has 100-TH in final. FZM has 807 final and an RME-69 receiver. GPC goes to Washington for the summer.

Traffic: W3GPC 103 GTS 67 (WLQE 24) CSY 13 EXQ 11 GKB 8.

WEST VIRGINIA—SCM, Dr. Wm. H. Riheldaffer, W8KKG—MZD attended some kind of a convention in Chicago. JRL put up a signal squirter for 14 Mo., but it didn't stay up. KWI put up a Mim's job for 14 Mc. QOE applied for O.R.S. FQB reports from Schenectady. TI is on the west coast studying under Terman at Stanford. His brother is in Lynn, Mass., with G.E. 9CEE is chief engineer at WBLK, and 8KLP is one of the ops. there. KSJ is still on 7 Mc. KYJ shot a new high-voltage transformer. OLV met his instructor in Morse during the war after years of separation; the contact was accidentally made on 3.5 Mc. MIP has a new Patterson PR-15. 3ZD visited KKG while in town on business. PZP is back on the air. PZT is after 'phone DX on 28 Mc. ELJ is on the air after a year's absence.

Traffic: W8QOE 11 OLV-KYJ 24 KSJ 2 HD 15 MCL 30 CZ 15 ELJ 7 CFB 16 HWT 25 BOK 11 JRL 15 KKG-NAU 17 MCR 9.

HUDSON DIVISION

EASTERN NEW YORK—SCM, Robert E. Haight, W2LU—ISQ is going to Culver Military Academy, Culver, Ind., for the summer. KJC in Larchmont has FB rig. JWT has new Super-Skyrider. CC changed QTH to 58 Fayette Rd., Scarsdale. Due to new position and new QTH at 509 West 112 St., N. Y. C., HYC must resign as R.M. and T.L. station. E. N. Y. will miss him and hopes to have him back soon. CYW has new altitude antenna and hears 2JAX, JQP, CSN, DVC portable and DWK consistently about 87-8. JBQ has portable rig. DSK, ILA, FBA and CGS are on 56 Mc. HNH is trying 56 Mc. ALP is rebuilding as per Millen's May/June QST dope. 5ABD is operating portable 'phone-c.w. rig. 2GXL is working with G.E. at Schenectady. GUM is operating portable 3.5- and 7-Mc. c.w. in 8th dist. IKV attended N. E. Convention at Providence, R. I. ACB is rebuilding. 3EDA has gone back to M.I.T. HUM returned from Florida and now goes to Adirondack boys camp. ITK applied for O.R.S.

Traffic: W2ISQ 14 JWT 37 CC 5.

NEW YORK CITY AND LONG ISLAND—SCM, E. L. Baunach, W2AZV—JBL joined the A.A.R.S. SM5UU, who is ex-FFV, is back again, now located with ETT, and would like to hear from any of the gang who QSOed from his SU QTH. BVE is chasing clouds since he got his flying ticket. BMW is also air-minded. LG is operating on the S.S. *American Farmer*. BYK is going home to Asbury Park for the summer. After a long absence APJ is back on 56-Mc. portable. IHT was local "hero" at school exhibit with his rig. JFP can be heard on 56 Mc. HGO is breaking in a new op at East Setauket. FF is rebuilding rig for half-kw. 'phone. CHK has 195 watts input to a T55. JEQ is operating on 7 Mc. experimentally. HMJ is looking for Nevada for W.A.S. JGF got Class A ticket. OQ contacted Hawaii on 7 Mc. IOP will be an op at ham station at B.S.A. National Jamboree at Washington. D. C. KAM is building a 100-watt job. IXZ is running ten watts input to a 71A T.N.T.; he was heard in Ireland when using 7 watts input. EVA is getting FB cooperation with his QSL bureau, but has plenty more uncalled-for cards. HXT has the rebuilding bug. KIK

(Continued on page 88)

THEY ARE TALKING ABOUT GROSS CP-55 and CB-55 TRANSMITTERS

- Full 95 Watts input ● New Taylor T20 tubes
- Ten Meter operation ● Built-in power supply
- For operation on 10-20-40-80-160 meters
- 3 stages, 42 Osc, 6L6 buffer, 2-T20's in final

KIT \$42.70

Less tubes, meters, crystal — One set coils included in price

The "CP-55" uses the marvelous new T-20's in the output stage. These real transmitting tubes will give outputs and performance not possible with ordinary receiving tubes — their price is very low.

The ideal unit for the beginner or the "Old Timer" desiring an additional Transmitter for operation on 10 meters, or any other band. In the CP-55 you have available an Xmitter having real power at a marvelously low price.

Compare the construction of the "CP-55" with units selling at many times its price. Only finest components are used such as Cardwell Condensers, Seatite Sockets, IRC Resistors, Cornell Dubilier and Aerovox Condensers, etc.

The CP-55 is converted into a fine RADIOPHONE TRANSMITTER by merely adding an available modulator unit.

Descriptive Bulletin on Request

"CW-55" RF Unit only as used in the CP-55 in-cluding one set coils, less tubes, xtal, meters. Kit **\$18.95**
Two full size surface type meters \$7.00
Coils, any amateur band listed in features, per set... 2.85
Kit of Matched tubes for RF Unit..... 6.60
One 83 Tube for power supply..... .65

"CB-55"

The Radiophone version of the "CP-55" — Also sensationally low priced

ALL BANDS INCLUDING 10 METERS
Bulletin gives Details

NEW!

"THE STANDBY" (2 to 2000 Meters) 3 TUBE A.C. AND D.C. RECEIVER

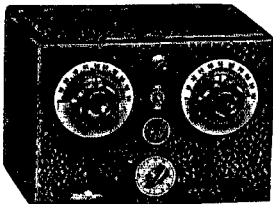

This excellent 2 to 2000 meter receiver is offered with full realization of the present-day need of the amateur for a dependable "stand-by" receiver which will cover, practically all of the radio bands in use today. Super regeneration, which is the most efficient form of

detection at these frequencies, is used from 2 to 15 meters. By throwing a toggle switch, straight regeneration and higher wavelengths up to 2000 meters may be had. Throughout the entire tuning range, there are no skips or dead spots. Loud speaker volume is available from practically every station received.

- 1000 to 1 tuning ratio. ● Super regeneration below 15 meters. ● Instant change over from straight to super regeneration. ● Power supply incorporated. ● Individual antenna tuning for high and low wave ranges. ● 1-76 super regenerative detector, 1-6J7 regenerative detector, 1-12A7 audio amp, and rectifier.

Complete kit of parts less coils, tubes, cab.	\$7.59
2-5-10 meter coils (set of 3)95
9 1/2 to 15 meter coil39
15-200 meter coils (set of 4)95
200-310 meter coil39
310-350 meter coil39
550-1050 meter coil60
1000-2000 meter coil60
Metal cabinet	1.50
Kit of three tubes	2.40
Wired and tested in our lab., additional	2.00

GROSS RADIO, INC.
51 VESEY STREET NEW YORK
Cable Address: GROSSINC

I. A. R. U. News

(Continued from page 80)

Hodges, W6MVH; Richard J. Buchan, W9TJF; Gene R. Bussey, W5EKK; Lee Hughes, W5DXA; Roy L. Knight, W3RT; Edwin C. Shaw, W6SH; Harry E. Garvin, VE3JZ; Leland W. Smith, W4AGI; Earl G. Krainik, W9BYE; Carl B. Evans, W1BFT; Tadeusz Chmielewski, SP1FP; Joe P. Curless, W6IYN; C. S. Pool, W6BCO; Leander J. Smith, W9EEZ; Carl W. Brown, W9AHR; Robert M. Loomis, W2BZC; W. Geo. Mitchell-Dwelly, VE5FU; H. E. Royer, W3CDG; James B. Ricks, W9TO; Larry LeKashman, W2IOP; D. W. Heightman, G6DH (#8-Mc. 'phone).

W6CNE

(Continued from page 55)

care of 20, when the station is operated portable on that band, as well as the b.c. entertainment when wanted.

The antenna is shown in the photograph of the car. It is a simple end-feed arrangement, using tubing, and its length is adjustable for the three bands used. It has given very satisfactory results on both transmitting and receiving.

The a.c. for the outfit is supplied by a 350-watt, 110-volt gasoline-engine driven generator made by Kato. This unit is mounted on the front bumper, as shown in the photograph. Ignition noise has been very successfully suppressed, but so far the noise from the generator itself has resisted all attempts at filtering, and information on how to cut out this type of noise would be appreciated by CNE.

On 28 Mc. while working mobile, contacts have been made with G5NI, G6LK, VK2GU, with the Argentine, Canada and all parts of the U. S. One of the best contacts was with W9BHT, when 100 per cent communication was maintained for the whole of a 27-mile trip from W6CNE's home in San Fernando Valley to the heart of Los Angeles. The group picture was taken during a lunch-hour QSO with W5GAU. The movie atmosphere is accounted for by the fact that W6CNE (by way of introduction, J. Roy Hunt, Canoga Park, Calif.) is Chief Cinematographer at RKO.

Strays

Speaking of call-book coincidences, W1GKM discovers that W8OMA, W8OMB and W8OMC are all held by Smiths, all in different towns!

VR2FF writes that he hasn't seen mention in QST of the method of wiring up the customary five-prong crystal socket so the oscillator will perk no matter how the crystal is put in the socket. A simple stunt, so obvious it never occurred to us!

Through the courtesy of Raytheon, we have the following data on interelectrode capacities of the 6L6 and 6L6G types:

	C_{g2}	C_{g1}	C_{p1}	
6L6 (shell grounded).....	0.46	12.84	14.34	μfd
6L6G (unshielded).....	1.40	11.62	9.96	μfd
6L6G (close-fitting shield) ..	0.85	12.88	14.74	μfd

GAMMATRON

Compare—

BEFORE YOU BUILD YOUR RIG—

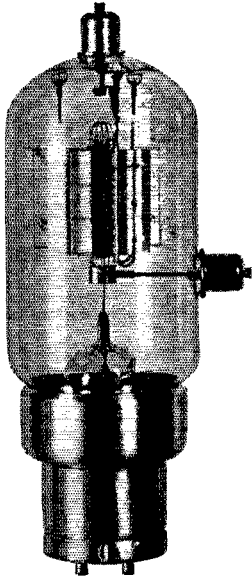

TYPE 354C

LOW COST ULTRA-HIGH FREQUENCY TUBES

TYPE	154 GAMMATRON	TUBE A	TUBE B	TUBE C	TUBE D	TUBE E
Rated Plate Dissipation Watts	50	100	55	35	50	35
Grid Modulated Carrier Watts	70*	54	31	21	22	19
PRICE	\$12.50	\$13.50	\$8.00	\$8.00	\$10.00	\$8.00
Carrier Watts Per Dollar	5.6	4.0	3.9	2.6	2.2	2.4

AND GET THE MOST FOR YOUR MONEY!

* The Type 154 GAMMATRON is ideally suited to grid modulation. Because of its high overload capacity, conservative plate rating and its low amplification factor, the HK 154 far outstrips its competitors in the same price class for this purpose. Because of its characteristics and because a release of plate supply power takes place during peaks, linear grid modulation is possible at efficiencies in the order of 50% with the HK 154; with other tubes of higher mu, efficiencies greater than 30 to 40% are unattainable. Complete information on just how this can be done is yours for the asking.

TANTALUM PLATE
AND GRID

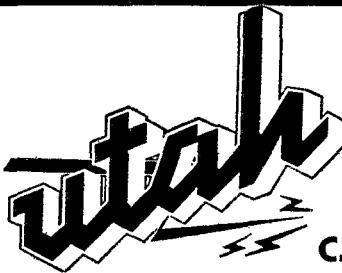
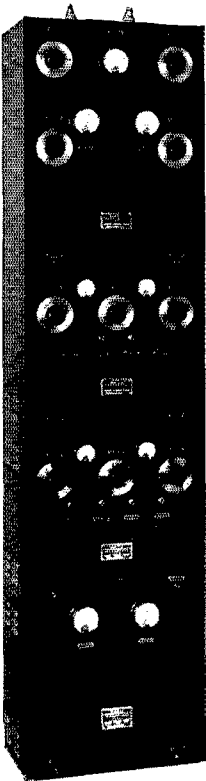

C. W. and PHONE

TRANSMITTER KITS

The Most Flexible Transmitter Kits Available Today

80 WATTS C. W.
500 WATTS C. W.

80 WATTS PHONE
500 WATTS PHONE

- Self-Contained Power Supply for each Unit
- Designed for Rack Mounting, or Speech Amplifier may be located at operating station
- Excited Unit may be used as separate emergency unit or as 80 Watt Portable Transmitter
- No extra parts required when connecting for phone or C. W.
- Link Coupling used throughout
- Universal Antenna Coupler "link coupled"
- Every circuit properly metered
- No relay rack required for 5 Unit mounting
- All bands on 2 or 3 crystals
- No. 2 kit makes excellent amplifier for public address
- Simply and easily constructed
- Lowest prices.

See these outstanding Transmitter Kits at your dealer today or write Dept. Q8 for complete information

UTAH RADIO PRODUCTS COMPANY
CHICAGO, ILLINOIS

Toronto, Ont., Canada

Buenos Aires (Ucoa Radio Products Co.)

(Continued from page 85)

finished rig with 42A in final. JYL is on 28 Mc. PF can be heard on 14 Mc. for the summer. BSR is preparing for 28-Mc. c.w. activity this fall. R.C.A.'s u.h.f. survey car keeps DOG traveling around the country. Ex-K6DV is now KJO operating on 7 Mc. using a pair of 6L6's. Regular operating frequencies: JHB3580, DW3695, EYS3710. We are still looking for more stations for the L. I. net which operates on 3710 kc. every night with DBQ as control station. The new officers of the City College Radio Club are IFS president, IOS chief operator, KCO treasurer. DBQ is working on modulator and receiver.

Traffic: W2DBQ 153 (WLN 97) JBL 99 PF 51 JHB 44 IET 40 OQ 37 FF 27 DW 26 IOP 22 AZV 20 JGC 15 HXT 8 APV 7 EYS-AA-CIT 6 HGO-BKP-BYL-HMJ 5 CHK-FLD 3 BFA-JEQ 2 DOG 1.

NORTHERN NEW JERSEY—SCM, Fred C. Read, W2GMN—FFY, formerly of Plainfield and president of the Plainfield Radiophone Ass'n, has changed QTH to the vicinity of Cleveland, Ohio, and will soon be a W8 on his old favorite, 3.9-Mc. 'phone GZG will appear on 14 and 28 Mc. soon. HLX sticks to 1.7- and 3.9-Mc. 'phone. JOU and JDO are on 1.7-Mc. 'phone. EKU is on 14-Mc. 'phone at new QTH in Scotch Plains. FSQ, GBY, GFG and JOQ spent two weeks at National Guard Camp at Indiantown Gap, Pa. GO works a VK on 14-Mc. 'phone before breakfast or counts the day lost. From reports published on the society page, DZV is about to go into a ham radio decline that lasts from one to infinity years. FZB is back in the radio servicing game. In the Original Tri-County Radio Association's attendance contest, BYD won a crystal microphone, IBR a Mac Key, and GMN a Mac oscillator. HRN has been experimenting with a 6L6 crystal oscillator. JMX has his T20 final working in fine shape on 1.7-Mc. 'phone. CHH has been active on 3.5- and 7-Mc. c.w. IOZ is new O.P.S. KDQ is new arrival on 56-Mc. 'phone. JYK burned out a transformer. IZV has full-wave 1.7-Mc. antenna. CGG wants summer traffic schedules in New Jersey and New York City. BCX is rebuilding his transmitter. The local N.C.R. members had a review at Long Branch on June 20th. JYP and GVG are new stations in Roselle Park. Alan Wilson, K5AY and DX Contest champ, is back home and will soon be heard with his old call, 2BXU. JUC has Collins antenna coupling system and an improved signal. HNP has job in transmitter building plant. KMY is a new station in Ocean Gate. The N. N. J. QSP Club had a picnic at Lake Hopatcong on July 12th. IYG's ambition is to have an ultra high-quality 'phone signal. Don't forget to give the old rig the once-over before the fall season opens, so that everything will be in readiness for big doings. The S.C.M. wishes you an enjoyable summer.

Traffic: W2BCX 179 (WLNF 268) CGG 262 HNP 124 GVZ 91 ICJ 37 HTX 36 CIZ 25 GMN 19 IQM 18 JUC 12.

ATLANTIC DIVISION

EASTERN PENNSYLVANIA—SCM, James M. Bruning, W3EZ—R.M.'s: 3AKB, 3AQN, 3EOP, 3ASW. P.A.M.: 3EOZ, 3GRS is a new ham in Yeadon and has started with a 25 watt 6L6 rig. 3FPW sent us a copy of the Beacon Radio Amateurs' very fine paper "Parasitics." Eastern Radio Club took part in A.R.R.L. Field Day with 3GJM, 3AMR, 3EOP, 3FIS and 3NF active. 3FXZ sent in her last report and is now settled in New England. 3EDC is looking for new A.A.R.S. members. 3GMK received his R.C.C. certificate. 3GDI has had sickness and death in his family. The gang sends sympathy. 3AKB is rebuilding. 3ASW lost two '66's and one appendix. Wonder which he misses the most? 3EWJ is a member of the R.C.C. 3ETA has been having trouble with his final amplifier. 3CXE sends a report that Jimmy Gantz (the Picture Snatcher) is now 3GXX, also that 3FSD is now Class A and is using 14 Mc. 'phone. 3BQ has been doing a little construction work. 3GJY worked four VK's in eighty minutes with 33 watts and a new Marconi aerial. 3DXC is building a portable transmitter and receiver. 3EOZ entertained G5NI for about a week. FLASH! Mrs. SEU presented the Old Man with 7 pounds 9 ounces of Junior Op. Congratulations! 3BGD blew up a 211 amplifier and has been running 15 watts with excellent results. 3QP is now fully equipped for Portable or Emergency work with a Gas-driven Katolite Jr. of 350 watts. The Beacon Radio Amateurs made extensive plans for Field Day. 3FAJ is another recent member of the R.C.C. 3FLA has another RK-20 tri-tet and thinks very highly of its usefulness. 3BRZ had a slight relapse due

to hot weather and only worked six VK's, a G5 and an SP this month. 3CHH, 3EZ and 3FRY were active as usual. 3CGM won the first transmitter hunt of the Main Line Radio Club series by locating the 1.75 Mc. rig in 22 minutes. The hundred watt transmitter (built by 3EOZ) is hidden for each hunt within a 75 square mile area. 3EZ came in two minutes later and 3FRY scored third place.

Traffic: W3QP 271 AKB 103 EWJ 74 (WLQH 7) FXZ 74 EDC 65 NF 38 (WLML 296) EOP 14 GMK 12 EML 9 FPW 6 AQN 5 DXC-BGD 3 EUP-EZ-FAJ-EOZ 2. W8FLA 154 ASW 17 BQ 11 AXH 2.

MARYLAND-DELAWARE-DISTRICT OF COLUMBIA—SCM, Edgar L. Hudson, W3BAK—R.M.'s: 3CXL, 3EOU, 3CQS. Chief R.M.: 3BWT. BKZ worked FY8A for country number 80. KA is going to Miss. for several weeks. CW8 landed a job with U. S. Steel in Pgh. DRE put iron core air tuned i.f. transformers in his FB7 with 100 per cent improvement; he has worked 42 states. CGK, formerly of Darlington, Md., has changed QTH to Box 15, Rising Sun, Md. EHW took part in Field Day; made 72 contacts on 3.5, 7 and 56 Mc. using call of FRB. CDQ, Washington's YL opr., is leaving July 14th and will spend her vacation in England, France, Holland, Belgium, Germany, Switzerland and Italy, returning Oct. 11th. The following notes from W3EZN of The Washington Radio Club: The last meeting of the year was held with combination Hamfest-Club meeting. A hand-turned maple gavel with wood from George Washington's estate was presented W3ER, president of the Club. The gavel was fitted with an engraved band. GUV has new Harvey 80T 'phone and C.W. rig with HRO.

Traffic: W8CXL 178 (WLM 1764) BWT 510 DQN 88 (WLMC 892) SN 277 CIZ 49 BKZ 67 FSP 10 KA-CWE 4 CDG 2 FPQ 1.

SOUTHERN NEW JERSEY—SCM, W. W. Filson, W3BEI—ZX retired as S.C.M. after completing a full term of two years. BEI took over as S.C.M. for the Section beginning June 15th. BO handled traffic from National Guard Camp at Indiantown Gap, Penna., June 12th-25th. FTX has his eye on an O.R.S. GX4, GVC and GVO are brand new amateurs in Atlantic City. ARW is working on the boardwalk. FPM is building a new receiver.

Traffic: W3BEI 15 BO 14 FTX-ZX 2.

WESTERN PENNSYLVANIA—SCM, Kendall Speer, Jr., W8OFO—R.M.'s: 8KUN, 8KWA, 8MOT. The Annual Big Hamfest of the S.H.B.P. & M. will be held August 1st at the same place, Clatty's Driving Range, Bowerhill Road, Mt. Lebanon, Pittsburgh. Approximately 600 attended the Atlantic Division Convention at Erie on June 25th-26th. Notables there were 8CMP; 3QV; 1SZ; Milton Grinnel, the R.I.; John Reinartz, 1QP; and 8CPC. Some of those present from Western Penna. were 8KWA, MOT, KOB, AXD, ONW, QEL, OJL, OKS, OVT, FTY, JWZ, RG, CHT, GLA, AIG, KER of YA, and OFO. CMP leaves for his summer home in Michigan shortly. OFO finished overhauling the rig and painting the shack. PFW of Somerset is using a 6L6 osc. and pair of 6L6's final. QAN worked 6BIC in Nevada which makes him W.A.S. GXC moved from Cleveland to East McKeesport and will be on with a Harvey 80T. He will operate in the basement and PFV in the attic. GJM's new 50 foot mast and 252 foot sky wire was struck by lightning with slight damage. LOR is on 14 Mc. with a T55 at Bellevue.

Traffic: W8CMP 59 OFO 50 NDE 26 KUN 16 PFW 14 QAN 10 KOB 4 AXD 2.

WESTERN NEW YORK—SCM, Charles F. Smith, W8DS8—R.M.'s: 8JTT, 8BJO, 8AQE. P.A.M.: 8CGU. Liaison Officer: 8CSE. CSE leads in traffic and reports new officers elected by Syracuse Radio Club: NUY, pres.; PJO, vice-pres.; APU, reflected secy-treas. FCG and FUG are on consistently. KYR did some fast relaying for Sea Scout station in Buffalo. GWT contacts 3USA at National Jamboree daily. QHX needs only Asia for W.A.C. KXA now has Class A ticket. PCW received a Mac-Key as high school graduation present. MFB worked his 58th country. HTT is now a benedict and has moved to Erie, Pa. QQQ is president of Clayton Radio Club. PFJ and NA applied for O.P.S. PLA, from his summer camp, is promoting an FB round robin letter idea. Prospective O.P.S. taking the test now will have to have a real quality signal because CGU, our P.A.M., won an oscilloscope at the Convention! Hope you all enjoy your vacations. 73.

Traffic: W8CSE 83 FCG 45 FUG 36 PLA 34 DHU 29 KYR 20 GWT 9 CGU 8 QHX 2. W2HTX-8 35.

A NEW DAY

... IN THE ART OF SOUND REINFORCEMENT AND REPRODUCTION

● The Day of the *Bass Reflex* and *Peri-Dynamic* Principles . . . Basic New Art Which Will Dominate the Whole Future of the Industry . . .

● The Day of the *Complete Loud Speaker* . . . No Baffle Required . . . Makeshift Baffles and Boxes Are Now as Out of Date as a Hand Crank for the Automobile . . .

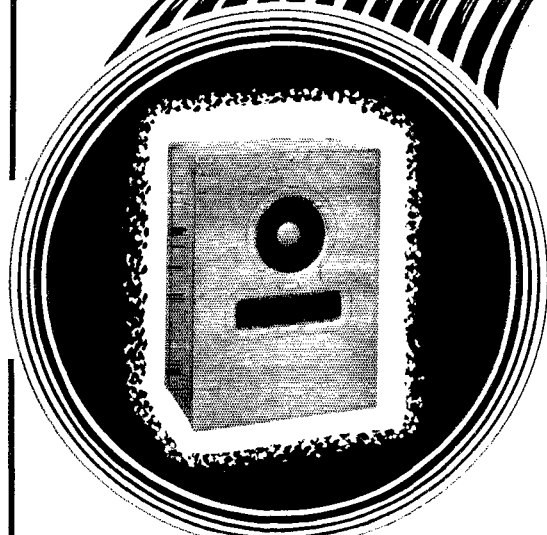

Jensen

PERI-DYNAMIC REPRODUCERS

Models KM and KV

For every known application of loud speakers . . . Radio Sets, Speech and Music reinforcement, Stage and Floor Show reinforcement, Hotels, Schools, Studios, Homes, etc. . . These new reproducers are undeniably the greatest advancement since the electro dynamic speaker . . . with new and specific performance ability engineered by the Jensen Laboratory and brought direct to the field of application.

Model KM Reproducer — Four sizes for 8, 10, 12 or 15 inch speakers, all with *Bass Reflex*, essential to the best reproduction in music, adds new octaves of low frequency. Speech is crisp and intelligible. Actually, performance is better than an infinite baffle. Prices as low as \$20.50 complete with highly efficient Jensen 8-inch speaker.

Model KV Reproducer — Three sizes for 8, 10 or 12 inch speakers, designed for really understandable speech reinforcement. The lower frequencies, not essential to good voice reproduction are eliminated. These models are relatively smaller than "KM" Models because of their function. Prices are as low as \$12.50 complete with Jensen 8-inch speaker.

These outstandingly new Jensen products are additions to what has always been the most complete line of loud speakers and accessory

equipment. Thus, the field of operation and profits for Jensen jobbers and dealers continues to expand.



Note convenient flat package in which enclosure is shipped . . . the speaker car on is also included.

Models KM and KV are shipped in kits consisting of speaker and knock-down enclosure. Easy to assemble . . . only a screw driver is needed. Enclosures are finished in French gray, giving attractive appearance. But they can be readily painted over to harmonize with any surroundings. Thus the innovation not only brings an entirely new standard of performance to the industry but also solves the baffle problem in a convenient and highly practical manner. *But there is no price premium for these advantages; check this statement carefully!*

Jensen

"The Name Insures
the Quality"

JENSEN RADIO MFG. CO. QST-837
6601 S. Laramie Avenue, Chicago, Ill.

FREE

Please send me FREE 12-page folder, "The Guide to a New Day" and other descriptive literature . . . giving complete technical information about these New Jensen Peri-Dynamic Reproducers.

Name

Address

City.....State.....

NEW "MILITARY-TYPE" HAND MICROPHONE

At last—a Hand Microphone specially engineered and designed to fit naturally in the palm of the hand. Gives maximum convenience and utility. Small, light, and compact—yet rugged and dependable. No bothersome handle. Easily slipped into pocket when not in use. Requires minimum space in portable equipment.

See your Jobber or Write for Bulletin 146Q today!

Shure patents pending.

Licensed under patents of the Brush Development Company



Model 750A. General-Purpose Crystal Hand Microphone. List Price, complete with cable and suspension hook, only.. **\$25**

Also available in Carbon Models—List Price from \$15 to \$21.50.



New HYVOL CAPACITORS



Ultra-compact high-voltage oil-filled capacitors. • Based on use of new exclusive HYVOL—the super-dielectric oil. • Sturdy steel container. High-tension terminals. Leak-proof. • Conservative ratings. Long life. • Compare quality—and prices, too!

TYPE 609 CAPACITOR PRICE LIST

	600 v. D.C.		1000 v. D.C.		1500 v. D.C.		2000 v. D.C.	
	List	Net	List	Net	List	Net	List	Net
1 mfd.	\$2.75	\$1.65	\$3.00	\$1.80	\$3.75	\$2.25	\$4.50	\$2.70
2 mfd.	\$3.50	\$2.10	\$4.50	\$2.70	\$5.00	\$3.00	\$6.00	\$3.60
4 mfd.	\$4.50	\$2.70	\$5.00	\$3.00	\$8.00	\$4.80

Ask . . .

Your jobber or us for new catalog—the big 32-page book with many new items.



Re 28 Mc.

"On several nights or early mornings we have noticed here that the 28-mc. band was wide open, yet there were no signals on it except harmonics from 14 mc. and commercials. The time of this observation has been around 11:00 p.m. to 3:00 a.m. CST; at 3 a.m. the signals did not seem to be weakening at all. Several W6's have been asked to listen at these times and they all report the band alive with those harmonics, indicating that the band is open. W4AJY in Birmingham first noticed this condition. It has also been noticed that whenever skip on 14 mc. is short the 28-mc. band is OK."

—W4DGS, SCM, Alabama.

It is suggested that amateurs equipped for 28 mc. make nightly observations on that band. Just because there are temporary dead spells, it does not mean that the band will not open up again—and more than likely when least expected. Keep an ear on 28 mc. and get in on some of those QRM-free QSO's when conditions break.

The New England Division Convention

CONVENTIONS in New England are an institution and the response of the amateurs to this year's convention held in Providence, R. I., on May 21st–22nd, was most gratifying to The Associated Radio Amateurs of Southern New England who sponsored the affair. With a registration of nearly 400 the attendance was a pleasant surprise to everyone. As the committee had prepared a good program, there was not an idle moment, and the trips planned were conducive to making everyone feel congenial. Those with a sporting inclination found it possible to attend the races at Narragansett Park.

The best of speakers addressed the meetings during the two days of the convention. It is needless to go into the detail of the addresses, but the mentioning of such names as John L. Reinartz, W1QP, representing R.C.A.; L. S. Fox, of National Carbon Co.; Samuel Stiness, W1HXS, New England Tel. & Tel.; Dr. Howard L. Andrews, of Brown University, will show the variety of subjects covered. The Army and Navy were well represented by Captain Morris and Lieutenant Noble, respectively. Director Percy Noble and F. E. Handy, Communications Manager, were busy men during the convention. Mark MacAdam, W1ZK, in his efficient manner had charge of the Code Speed contest, the winners of which were: Kenneth Bishop, W1EWD, perfect hand sending; W. J. Barrett, W1JAH, receiving and J. F. Lamont, semi-automatic key transmission, for which they each received a beautiful Silver Cup. That well-known speed champion, T. R. McElroy, gave another of his demonstrations and copied, unofficially, 82 words per minute.

At the banquet the convention was honored by the presence of Attorney-General Hartigan, representing His Excellency, Robert E. Quinn, Governor of Rhode Island, who extended the greetings of the state.

All in all it was a first-class convention and everyone seemed to be enjoying every part of it. Our thanks to Vincent O'Neill and his committee.

—A. A. H.

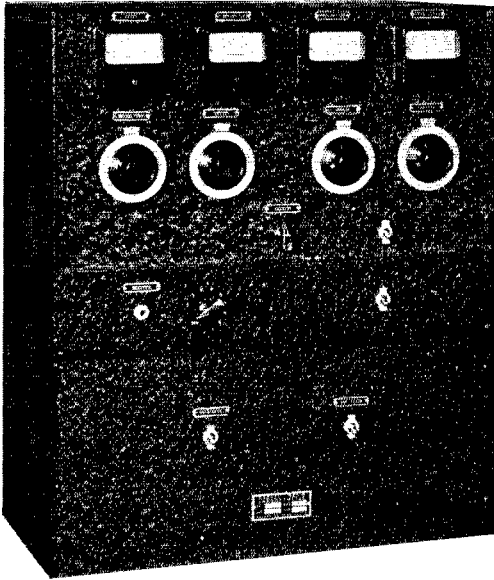

80-T TRANSMITTER

- Covers all bands from 10-160 meters on phone and cw.
- Has all necessary controls and meters, yet is simple to operate.
- Compact in size and well proportioned for restricted space.
- Reasonably priced and may be purchased on easy payments.

Write for Information

HARVEY RADIO LABORATORIES, INC.

12 Boylston St., Brookline, Mass.

Export: 25 Warren Street, New York City.

Cable: "Simontrice"

Exclusive Distributors of Harvey Transmitters in N. Y. C. area

TERMINAL RADIO CORP.

80 Cortlandt Street, New York City

Complete line of transmitters on display. Come in and see them

PRECISION CRYSTALS



Crystal Holder

Highest quality crystals, one inch square, carefully ground for frequency stability and maximum output. Be sure of your transmitter frequency — use PRECISION CRYSTALS.

Low frequency drift crystals (Type L.T.C.) supplied within 0.1% of your specified frequency and calibrated to within 0.03% are priced as follows: 1750 and 3500 kc. bands — \$3.50 each. 7000 kc. band \$4.00 each. Holder \$1.00.

(Holder as illustrated to fit G.R. jacks or round holder to plug into a tube socket can be furnished. G.R. jacks to plug illustrated holder into — \$.15 pair.)

'X' cut PRECISION Crystals carefully ground for maximum power supplied within 0.1% of your specified frequency and calibrated to within 0.03% are priced as follows: 1750, 3500 and 7000 kc. bands — \$3.00 each. Add \$1.00 if holder is desired.

'AT' cut crystals for commercial use quoted on at your request. When ordering our product you are assured of the finest obtainable. Now in our seventh year of business.

PRECISION PIEZO SERVICE

427 Asia Street

Baton Rouge, La.

*Immediate Delivery
of 80-T and other*

Harvey Transmitters

Convenient low down payment and terms with only 6% finance charge. 80-T monthly payments only \$9.89.

Write for information

HENRY RADIO SHOP

BUTLER, MISSOURI

Bob Henry, W9ARA

RADIO ENGINEERING



RCA Institutes offer an intensive course of high standard embracing all phases of Radio. Practical training with modern equipment at New York and Chicago schools. Also specialized courses and Home Study Courses under "No obligation" plan.

Illustrated Catalog on request

RCA INSTITUTES, INC. Dept. ST-37

A Radio Corporation of America Service

75 Varick St., New York

1154 Merchandise Mart, Chicago



KENYON

EFFICIENT
 ■
RELIABLE
 ■
MODERN
 ■
LOW PRICED

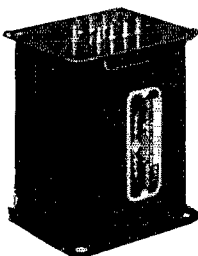

KEN-O-TAP

The **RELIABLE** Solution to the Modulation Problem

KEN-O-DRIVE

The **MODERN** Answer to Critical Driver Operation

KEN-O-DYNE

The **EFFICIENT** Method of Matching **OUTPUT TUBES TO SPEAKERS**

Ask your dealer for our 16-page "T" line Catalog which contains one of the most complete lines of Audio and Power Components ever presented. Also contains a large selection of Modern Audio Circuits.

Kenyon Transformer Co. Inc.

840 Barry Street, New York, N. Y.

Export Dept. 25 Warren Street, New York, N. Y.

EXCEPTIONAL OPPORTUNITY

OPPORTUNITY to purchase one of the leading internationally known Radio Wholesale, Retail, Mail Order Businesses. Enjoying finest reputation in the country. Excellent credit status. Proven earnings and clean stock make this a rare opportunity. Can be bought at an appreciable saving over actual worth. Will make an excellent nucleus for mail order chain. Specializing in amateur equipment, located in the East.

Address all communications to

H. BLOOM

2 Rector Street New York City

Telephone: Whitehall 4-7765

Brief

W6OLN and W6LHT, Los Angeles, working portable-mobile on 56 Mc., dropped into a drive-in eating place. From there they were working portable-mobile W9LHS-6, who was located in the hills above the city. W9LHS asked them to order him a couple of hot dogs and bring them up when they drove up to see him. Just as the waitress came up to the car with the "dogs," W9LHS' voice came out of the speaker and demanded to know why the waitress was so slow with his order. The boys then had a spellbound waitress on their hands and had to explain quite a bit. She was finally convinced it wasn't "spooks" when they let her talk two-way with 9LHS.

Standard Frequency Transmissions

Date	Schedule	Station	Date	Schedule	Station
Aug. 4	BB	W9XAN	Sept. 3	BB	W6XX
Aug. 6	BB	W6XX		A	W9XAN
	A	W9XAN	Sept. 4	BX	W6XX
Aug. 7	BX	W6XX	Sept. 5	C	W6XX
Aug. 8	C	W6XX	Sept. 10	A	W6XX
Aug. 13	A	W6XX	Sept. 17	B	W9XAN
Aug. 20	B	W9XAN		B	W6XX
	B	W6XX	Sept. 22	C	W9XAN
Aug. 25	C	W9XAN	Sept. 24	B	W9XAN
Aug. 27	B	W9XAN		A	W6XX
	A	W6XX	Sept. 29	BB	W9XAN
Sept. 1	BB	W9XAN			

STANDARD FREQUENCY SCHEDULES

Time (p.m.)	Sched. and Freq. (kc.)		Time (p.m.)	Sched. and Freq. (kc.)	
	A	B		BB	C
3:00	3500	7000	4:00	7000	14,100
3:08	3600	7100	4:08	7100	14,100
3:16	3700	7200	4:16	7200	14,200
3:24	3800	7300	4:24	7300	14,300
3:32	3900		4:32		14,400
3:40	4000				

Time (a.m.)	Sched. and Freq. (kc.)	
	BX	
6:00	7000	
6:08	7100	
6:16	7200	
6:24	7300	

The time specified in the schedules is *local standard time at the transmitting station*. W9XAN uses Central Standard Time, and W6XX, Pacific Standard Time.

TRANSMITTING PROCEDURE

The time allotted to each transmission is 8 minutes divided as follows:

2 minutes—QST QST QST de (station call letters).

3 minutes—Characteristic letter of station followed by call letters and statement of frequency. The characteristic letter of W9XAN is "O"; and that of W6XX is "M."

1 minute—Statement of frequency in kilocycles and announcement of next frequency.

2 minutes—Time allowed to change to next frequency.

W9XAN: Elgin Observatory, Elgin National Watch Company, Elgin, Ill., Frank D. Urie in charge.

W6XX: Don Lee Broadcasting System, Los Angeles, Calif., Harold Pery in charge.

Schedules for WWV

FOR transmissions and schedules of standard time intervals and ionosphere bulletins see "WWV Services Again Expanded," June, 1937, QST.

Each Tuesday, Wednesday and Friday (except legal holidays), the National Bureau of Standards station WWV will transmit on three frequencies as follows: 10:00 to 11:30 A.M., E.S.T., 5000 kc., noon to 1:30 P.M., E.S.T., 10,000 kc., 2:00 to 3:30 P.M., E.S.T., 20,000 kc.

16,954 RADIO MEN CAN'T BE WRONG!

The National HRO

Complete Band Spread coverage, 1700 KC to 30,000 KC. Nine Tubes (not including rectifier). Two pre-selector stages. Strictly single-control tuning. Four-gang precision condenser with pre-loaded, worm-drive tuning, 20-1 ratio. Two I.F. stages with Litz-wound coils, air condenser tuned. Beat Frequency Oscillator for "offset" C.W. tuning. Single Signal (Crystal Filter) standard equipment. Direct reading micrometer dial spreads tuning over 500 divisions, numbered every 10 divisions. Complete with tubes and four sets of coils covering 1.7 mc. to 30 mc., less speaker and power supply. \$179.70

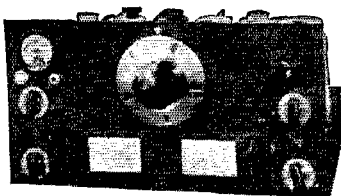

AND HERE'S WHY! 16,954 buyers of amateur radio supplies and service equipment who are on our active list of customers know from experience that Sun Radio Company is a most reliable place to buy. They know that even "hard to get" items are in stock here. They know, too, that they can depend upon our shop-by-mail service in cases where it is inconvenient to visit us in person. It took us over 15 years to build this reputation and because we guard it so jealously you can be assured of just that little extra measure of service.

The New 1938 Super Sky Rider

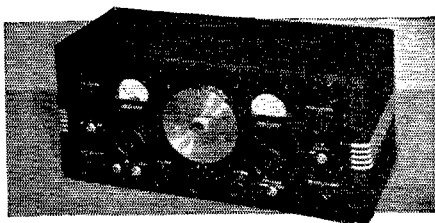

Complete coverage 5-550 meters. More than 1000' Electrical Band Spread. Wide range variable selectivity. Dozens of other quality features. Write for details of our Time Payment Plan. Liberal allowance on your present receiver. Price less speaker and crystal. \$99.00

AUGUST HIGHLIGHTS from SUN RADIO

- 1 The new Hallcrafters 1938 model Super Sky rider. Write for our time payment plan. Other models in stock. Liberal allowance on your old receiver.
- 2 We have a complete stock of National parts and accessories. Write for Bulletin No. 261. It's Free!
- 3 National Receivers in stock: HRO, HRO Jr., NC-100, NC-101-X.
- 4 We are the largest Distributor for Stancor Transformers in New York City and have a complete stock. Write for free X'mtr manual.
- 5 **BILEY CRYSTALS.** BC3 @ \$3.95; LD2 @ \$4.80; HR2 @ \$6.50; VF1 @ \$8.00. A large selection of frequencies in stock.
- 6 New Coto-Coil with variable link. All inductances in stock.
- 7 Stancor Plate Transformer, 1000v. at 300 M.A. \$5.75
- 8 The New MacKey \$9.50
- 9 The new C.H.T. Series by Thorlerson. A large variety of plate, filament, modulation, audio chokes and transformers. Free catalog shows prices and various types.
- 10 The new, improved Western Electric phones \$8.30
- 11 We have a complete stock of EIMAC, AMPEREX, RAYTHEON and RCA X-mitting Tubes.
- 12 RME, DB20 Pres-selector \$42.60

- 13 We are proud to announce our appointment as distributors for Western Electric Amateur Equipment. Write for Free Literature and catalog.
- 14 Western Electric (salt shaker type) 633A microphone, \$42.50
- 15 Before purchasing any test equipment, regardless of make, consult us. We can help you select the right equipment and save you money. Time payments and trade-ins considered. We stock: Supreme, Weston, Triplett, Dumont, Hickok, Simpson, Clough-Bregle.
- 16 All Taylor Tubes in stock: 806 Jr. @ \$1.00, 866 @ \$1.65, T20 @ \$2.45, T7-20 @ \$2.45, T55 @ \$8.00, T155 @ \$19.50, 814 @ \$18.50, 203R @ \$7.50, HD203 @ \$17.50, 756 @ \$4.95, T200 @ \$21.50, 204Z @ \$8.50
- 17 Electronic Converter for powering Portable Equipment. Output: 6 V.D.C. to 300 v. @ 100 M.A. Very rugged. \$13.23 net.

MONTHLY BULLETIN SERVICE

Get on our mailing list. Get "The Sun" every month . . . a tabloid news-magazine that lists money-saving specials, contains articles by Jack Grand, Ed Berliant and other members of our staff. Simply send postcard with name and address to Dept. Q-8.



RADIO CO.

227 Fulton Street, New York, N. Y.

Cable Address: SUNRADIO NEW YORK

- 18 Complete stock of Hammarlund Parts. Catalog Free.
- 19 New Dumont 5'' model No. 168 oscilloscope \$116.50
- 20 Sylvania 211C. Full guarantee. While they last \$6.75 net.
- 21 RME69 in stock. \$151.20 complete. Liberal allowance on old receiver.
- 22 Cornell Dubilier type TJ x'mitting condensers in stock.
- 23 U.T.C. transformers in stock.



The BRUSH Transfilter

FILLS THE GAP

The transfilter fills the selectivity gap between the electrically tuned circuit and the quartz filter. A transfilter can be employed in any superheterodyne whose intermediate frequency amplifier can be tuned to 465 kilocycles.

Technical data on request

The BRUSH Development Company

3320 PERKINS AVE., CLEVELAND, O.



BIRNBACH INSULATORS ARE SPECIFIED BY LEADERS

When leading designers lay out their new rigs they naturally specify parts that can "stand the gaff" yet are priced right. It's no wonder, therefore, that most designers specify Birnbach because Birco products give you the highest possible quality at the lowest possible price.

Improved Cone Standoff Insulators

Made of better ceramic. Complete range of heights. Condenser, coils, tube sockets, etc., can be mounted with minimum labor. White glaze.



No.	Heights	List
430	5/8"	10c
431	1"	15c
431J	1"	20c
432	1 1/4"	20c
432J	1 1/4"	25c
433	2 1/4"	25c
433J	2 1/4"	50c

NEW TRANSMITTING SOCKETS

- Side Wiping Contacts
 - Brass, Nickel Plated Shell
 - Highly Vitrified, Low Absorption Base
 - All Brass Hardware
- No. 434, 50 watt \$1.25 List ea.
No. 435, 10 watt 90c List ea.
- SPECIAL LOW PRICES in Large Quantities



BIRNBACH RADIO CO. INC.

145 HUDSON ST. BIRCO NEW YORK, N. Y.

On each Tuesday and Friday the emissions are continuous unmodulated waves (c.w.); and on each Wednesday they are modulated by an audio frequency. The audio frequency is 1000 cycles per second.

Amateur Equipment Cost of the Past

TO old-timers as well as the newcomer, it is interesting to follow the cost of amateur equipment down through the years. Starting with the first issue of *QST* we find J. H. Bunnell advertising "the best and handsomest transmitter" which sold for \$7.50. This was a straight key with the novel feature of renewable contacts "to eliminate fading due to varying resistance of the contacts."

At the beginning of 1916 loose couplers were widely advertised. One described as "handsome and will tune up to 1500 meters" sold for \$15.

Not until September, 1916, were tubes advertised. The famous Moorhead valve, which had no internal grid and which would "cutstatic 50%," retailed for \$6.50. The deForest audion tube also appeared in this issue and was listed at \$5.50. Variable condensers, not in micro-microfarads but number of plates, ranged from \$3 to \$5. A. H. Grebe advertised a "short-wave regenerative receiver" for \$32.50 which would tune to 1000 meters. This "receiver" consisted of a tapped coil and variable condenser mounted inside a beautifully finished box with a switch-point-studded panel with binding posts to go to the tube terminals or crystal detector, and 'phones.

By 1919 the cost of a variable condenser had come down to half its former price—providing you would assemble same yourself. The knocked-down condenser will be remembered by many.

Audio transformers came in packages of one for \$7 and one special brand cost \$20.

Headphones of this era were priced from \$5 to \$7 for domestic brands with an English firm advertising a pair for \$18.

Two-stage amplifiers all nicely housed in cabinets were available at this time for \$50. During 1919 the famous deForest unit construction receiver was advertised. The audion unit was probably the most popular item for \$10. The deForest wireless telephone transmitter to send voice 20 miles appeared in later 1919. This item sold for \$200 and operated directly from the 110-volt lines.

The famous UV200 and 201 tubes first appeared in 1921; the former retailed for \$5 and the latter \$6.50. Power tubes followed soon after with the 202 rated at 5 watts for \$8.

The "low-loss" era started in late 1923 and with it came an entirely new brand of advertisements—especially of low-loss condensers and coils. Late 1924 found the 1000-volt "S" tube rectifier on sale for \$10. In 1925 finished oscillating crystals first came on the market for \$25.

Certainly the amateur game of to-day doesn't tax the pocketbook in the manner it did twenty or even ten years ago.

TESTED AND

OK'd

FOR ACTIVITY

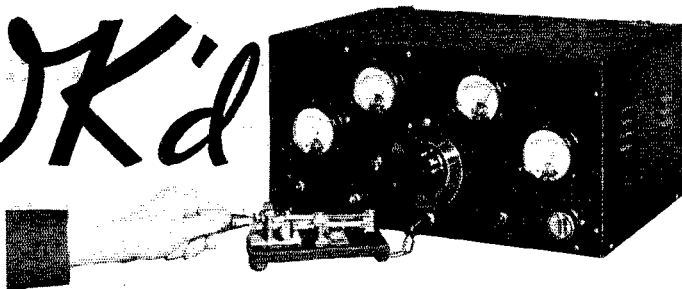

ACTIVITY in a crystal is a relative measure of its ability to be easily excited, to snap into action quickly and to follow rapid keying. To be really good, a crystal must possess high activity.

Through correct design, the employment of special precision machinery and constant checking of every operation, high activity is assured in all Bliley Crystals. As a final positive check each unit must be able to follow rapid keying in a standard oscillator loaded to simulate actual operating conditions.

For the best in crystal control, use Bliley. For the 40-80-160 meter bands, get a Bliley LD2 Unit from your nearest distributor. He carries them in stock for \$4.80.

BLILEY ELECTRIC CO.

ERIE, PA.

BLILEY CRYSTAL UNITS

R A D I O

ENGINEERING, broadcasting, aviation and police radio, servicing, marine radio telegraphy and telephony, Morse telegraphy and railway accounting taught thoroughly. Engineering course of nine months duration equivalent to three years of college radio work. School established 1874. All expenses low. Catalog free. **DODGE'S INSTITUTE, Day Street, Valparaiso, Indiana**

\$100 for a RADIO KEY!!?

WORTH IT — but I only charge \$9.50

This semi-automatic key makes it easy to send! Dot stabilizer equipped. Selected main-spring. Marbleite finish base stays put. Chromium metal parts. Proper height for tireless, rhythmic sending. New 1938 Mac Key only \$9.50. Order Today! Also New Mac Straight Key — best ever — only \$2.50. Write for complete dope on other Mac items of tremendous help to radio ops.

T. R. McELROY — 175 Congress St., Boston, Mass.
WORLD'S CHAMPION TELEGRAPHER

LEARN CODE RIGHT

Tapes for Every Need — Even Airways
— Send You Typical Messages by
INSTRUCTOGRAPH

It's easy and practical to learn or improve your Radio or Morse Code, any speed. Senior model with 10 tapes and Book of Instructions — \$20.25. (Rented at low cost) Junior model with 5 tapes and Book of Instructions — \$12.00. (Not rented). Complete oscillator equipment, less battery, \$6.50. Write for details today.
INSTRUCTOGRAPH CO., Dept. Q-8
912 Lakeside Place Chicago, Ill.
Radio College of Canada
863 Bay St., Toronto



WE ALSO HANDLE: HALLIGRAFTER AND R.M.E. SHORT WAVE RECEIVERS — MICROPHONES — VIBROPLEXES — TAYLOR TUBES ... CASH OR TERMS

SPEER GRAPHITE ANODES

*make hot spots
and fused holes*

IMPOSSIBLE

Makers of better tubes use them. Write for list and booklet.

SPEER CARBON CO.

ST. MARYS, PA.

Ⓢ 7421

Say You Saw It in *QST* — It Identifies You and Helps *QST*

The RADIO SHACK

46 Brattle St Boston

NOW THE UHF 6

At last that 5 and 10 meter superhet with low background and sensitivity—6 tubes, special IF's, will bring in modulated oscillators but selectivity favors MOPA, punched chassis, and instructions and layout with each kit.



Complete Kit less tubes and cabinet \$26.50

Tubes, \$5.43 Cabinet, \$2.25

Wired and Tested, \$5.00

SPECIAL BUY—UTC Plate Transformers & Chokes

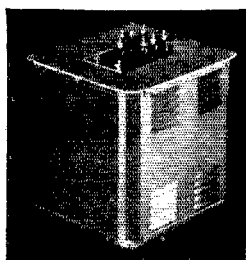

20462A—1000-750-0-750-1000 AC at 300 MA. DC. \$5.20

20462B—1500-1250-1000-0-1000-1250-1500 AC at 300 MA. DC. 6.75

20462C—2500-2000-1500-0-1500-2000-2500 AC at 300 MA. DC. 10.95

20462D—1500-1250-1000-0-1000-1250-1500 AC at 500 MA. DC. 10.95

20462E—575-525-0-525-575 AC at 500 MA. DC. 5.20

20462F—Smoothing Choke—20 Hy.-200 MA. 115 ohms DC Resistance. 2500 Volts Insulation \$1.45

20462FS—Swinging Choke—5-25 Hy.-200MA. 115 ohms DC Resistance. 2500 Volts Insulation 1.45

20462G—Smoothing Choke—20 Hy.-300 MA. 95 ohms DC Resistance. 3500 Volts Insulation 2.85

20462GS—Swinging Choke—5-25 Hy.-300 MA. 95 ohms DC Resistance. 3500 Volts Insulation 2.85

20462H—Smoothing Choke—20 Hy.-400 MA. 85 ohms DC Resistance. 5000 Volts Insulation 3.45

20462HS—Swinging Choke—5-25 Hy.-400 MA. 85 ohms DC Resistance. 5000 Volts Insulation 3.45

20462I—Smoothing Choke—20 Hy.-550 MA. 55 ohms DC Resistance. 6000 Volts Insulation 4.95

20462IS—Swinging Choke—5-25 Hy.—550 MA. 55 ohms DC Resistance. 6000 Volts Insulation 4.95

TAYLOR TUBES

Complete Stock on Hand

I-20... \$2.45 — T-55... \$8.00 — 866... \$1.65

NEW UTC VARITRAN—VC

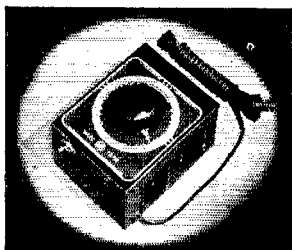

Compact, simple, rugged, inexpensive. . . . An ideal voltage control unit of the type employing a sliding contact riding over the transformer turns.

V-1—570 watts maximum rating, 115 volts, 50/60 cycles input. Output 0 to 130 volts. Complete with cord plug and switch, net \$10

The 1938 Super Skyrider

This amazing new communications receiver of Hallcrafters—to insure early delivery ORDER NOW.

Bassett Concentric Line

50 ft. . . \$9.75 75 ft. . . \$12.75 100 ft. . . \$16.75

MAIL ORDERS SHIPPED

Strays

VK4RM started checking over his cards to see what ones were needed for WAS, only to get pulled up short because he couldn't find anywhere a list of the states!

Two-Inch Cathode Ray Tube

Du Mont Laboratories are making a cathode-ray tube with a two-inch screen which in other respects is interchangeable with the 913. It is of the high-vacuum type with four electrostatic deflection plates, has a 6.3-volt heater and will operate with from 300 to 600 volts on the second anode. Suitable for those who want a low-voltage tube with larger screen area than the 913 gives.

W4DGS sends in a list of fifty calls heard on auto horns, says he needs only a W3 and W7 for HADOAH (Heard all Districts on Auto Horns)!

New Amateur Tubes

FOUR new small tubes have recently been added to the Raytheon "RK" line for amateurs. Two of these are of interest in low-power transmitters and in buffer stages, while the remaining two are designed primarily for portable equipment.

The RK-25B is the same as the RK-25 except for the base, which is bakelite instead of isolantite. At frequencies where the base insulation is of little consequence, this tube will do the same job as the 25. The reason for the bakelite base is to reduce the cost.

The RK-41 will be welcomed by those sticking to 2.5-volt filament supplies, being a beam tube identical with the RK-39 except for the filament, which takes 2.4 amperes at 2.5 volts. Which reminds us that the RK-39 tentative ratings as originally given in *QST* have been revised to make the maximum plate and screen voltages 500 and 300 volts respectively. The shielding in the tube has also been improved so that, with proper circuit shielding, it can be used without neutralization on all but the highest frequencies. The grid-plate capacity is 0.2 $\mu\text{fd.}$; input, 13 $\mu\text{fd.}$; output, 10.5 $\mu\text{fd.}$ Rated output as a Class-C amplifier at 500 volts plate and 250 volts screen is 35 watts.

The RK-42 is a small-size triode for portable applications. Characteristics are similar to those of the 30 except for the filament, which is rated at 1.5 volts and 60 milliamperes and is designed to operate from a single dry cell over the normal range of dry-cell voltage.

The RK-43 is also a dry-cell tube, with filament taking 120 milliamperes at 1.5 volts. It has two triode sections, each similar to that in the RK-42 except for a higher μ . Suitable for the uses to which double triodes ordinarily are put.

—G. G.

KENYON SPECIALS

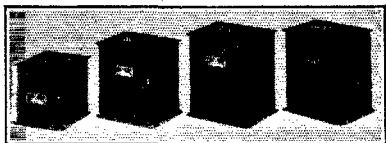

POWER TRANSFORMERS AND CHOKES AT UNHEARD OF PRICES !!! ALL CASED

POWER TRANSFORMERS

D200, 750-1000 V. each side at 300 mils.	Net \$5.25
D201, 1000-1250-1500 V. each side at 300 mils.	6.80
D202, 1500-2000-2500 V. each side at 300 mils.	11.00
D203, 1000-1250-1500 V. each side at 500 mils.	11.00

SMOOTHING CHOKES

D100, 20 Henries — 200 mils. 2500 V. insulation.	Net \$1.50
D102, 20 Henries — 300 mils. 2500 V. insulation.	2.90
D104, 20 Henries — 400 mils. 5000 V. insulation.	3.50
D106, 20 Henries — 500 mils. 6000 V. insulation.	5.00

SWINGING CHOKES

D101, 5-25 Henries — 200 mils. 2500 V. insulation.	Net \$1.50
D103, 5-25 Henries — 300 mils. 2500 V. insulation.	2.90
D105, 5-25 Henries — 400 mils. 5000 V. insulation.	3.50
D107, 5-25 Henries — 500 mils. 6000 V. insulation.	5.00

"X" CUT UNMOUNTED 40 METER CRYSTALS

Made by nationally known manufacturer. Your choice from our stock, only \$1.95. These are 1" square and have high output. Calibration is accurate to .1%.

Special Bailey 40 meter crystal holders,	\$.95
--	--------

W3AHR

MAIL ORDERS PROMPTLY FILLED

W3BMS

CONSOLIDATED RADIO CORP., 612 Arch St., Philadelphia, Pa.

THE NEW 1938 SUPERSKYRIDER

Just look at these features. Range from 5-550 meters! Variable selectivity control! 100% of band spread on 20 meters! alone! Net price complete, less speaker and crystal, \$99.00; extra for 12" pm speaker in cabinet, \$12.00; extra for crystal, \$12.00.

Immediate Shipment

TIME PAYMENTS ON ALL HALLICRAFTERS SETS

Pep up that low powered rig with a TAYLOR T-20, \$2.45

RAYTHEON RK39 TUBES ARE ONLY \$3.50. WHY PAY MORE?

EIMAC, 100th Tubes	\$13.50
EIMAC, 250th Tubes	\$24.50

WARD LEONARD — NEW! Antenna DPDT Changeover Relay, Mycalex insulation, 110 V.A.C. Field, \$5.88

JOHNSON "Q" ANTENNAS FOR BETTER DX

5Q, Five meter antenna system	\$3.83
10Q, Ten meter antenna system	3.67
20Q, Twenty meter antenna system	5.82

Those new Brush Featherweight Crystal Fones are supersensitive and are only \$5.29

LAST MINUTE FLASH!

NEW THORDARSON SPECIAL POWER TRANSFORMERS

T16PO-0, 640-810 V. each side at 200 MA, WT. 9 lbs.	\$3.96
T16PO-1, 1220-1510 V. each side at 300 MA, WT. 23 lbs.	7.80
T16PO-2, 1250-1540 V. each side at 500 MA, WT. 36 lbs.	12.60
T16PO-3, 1740-2140 V. each side at 300 MA, WT. 31 lbs.	11.40
T16PO-4, 2370-2950 V. each side at 300 MA, WT. 39 lbs.	13.95

HIGH FREQUENCY PROTECTION

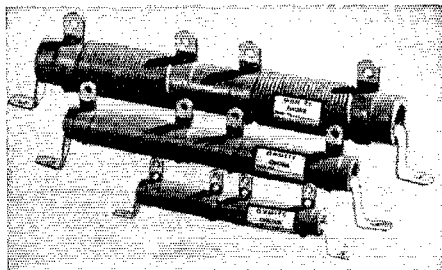

OHMITE POWER LINE CHOKES

Keep your neighbors happy, and eliminate complaints. Ohmite Power Line Chokes prevent high frequency currents from going out over the power line from your transmitter and causing annoying interference on your neighbor receiver. Why make a nuisance of yourself when for the slight expense of an Ohmite Power Line Choke, you can stop all trouble from this cause. Protect your own receiver the same way. See your dealer today. Built in three convenient sizes. Insist on OHMITE.

OHMITE MANUFACTURING CO.
4831 Fournoy Street Chicago, Ill.

MANUFACTURERS OF RESISTORS AND RHEOSTATS OF ALL TYPES

BUILD THE #1 STREAMLINER

1ST "ENGINEERED" TRANSMITTER TO WORK

THE 5-10-20 METER BANDS • CRYSTAL CONTROL



FINAL R F AMPLIFIER AND ANTENNA TUNER

EXCITER UNIT (CRYSTAL OSCILLATOR, BUFFER AND DRIVER)

POWER SUPPLY UNITS



NO MORE bread-board and haywire combinations that exhaust your funds and your patience! Get on the air **AT ONCE** with a crystal controlled signal that stays "in the groove." Work 5, 10 or 20 meters at will. Band changing is easy with plug-in coils. Operate with full 110 watt input, CW or phone. Easy to build at low cost starting with low power and exciter units. More power or phone can be added "progressively." Circuit diagram, directions, etc., in **AMATEUR TRANSMITTER GUIDE**, 25 cents from your jobber or Amateur Press, 1300 W. Harrison St., Chicago.

GENERAL TRANSFORMER CORP.
518 S. Throop St., Chicago

ASK YOUR JOBBER OR WRITE FOR FREE BULLETIN 48

Double Your Power!

At the Useful Voice Frequencies

Cut through QRM with a voice that can be understood. You don't need tricky high gain amplifier with this tremendously efficient voice microphone. Eliminates all RF feedback troubles with its "airtight" shielding. Cuts out your hum problems too. You'll get more satisfaction out of the dollars spent on a VT-73.



LIST—

- MIKE
- STAND
- PLUG

\$27.50

Write now for
bulletin 10-C

Model VT-73

THE TURNER COMPANY
CEDAR RAPIDS, IOWA

Licensed under patents of the Brush Development Company

WE OFFER —

SPECIALIZED PERSONAL SERVICE of genuine value that is not available from other jobbers.

TIME SALES of all receivers and transmitters with terms arranged to suit you and 6% finance charge. We finance our own paper. **TRADE IN** your equipment for the down payment.

HARVEY, RCA, RME, All Star, Progressive transmitters on terms. All amateur apparatus at net prices.

TRADE IN YOUR RECEIVER

All receivers shipped on ten day trial. You need send but \$5.00 with order, balance C.O.D. These receivers in stock:

RME-69s Complete	\$151.20
1937 Breting 14s	108.00
The new Patterson PR-15	109.50
The new RCA ACR-111	189.50
RCA ACR-155	74.50
RCA ACR-175s	119.50
The new 1937 Super Pro	238.14
The new Hallicrafters 1938 S-16 Super Skyrider	99.00
Hallicrafters Sky Challenger S-15	69.50
Hallicrafters Sky Buddys	29.50
Hallicrafters Sky Chiefs	44.50
Hallicrafters Ultra Skyriders S-10	99.50

Every order and inquiry is personally attended to by Robert Henry, W9ARA, an active amateur for twelve years; graduate E.E. from M. I. T. and owner of Henry Radio Shop selling amateur supplies for eight years. You can reach me by letter, telegram, phone call, or visit 24 hours a day, 365 days a year. Write for any information.

HENRY RADIO SHOP

211-215 North Main Street

BUTLER, MISSOURI

Class-B Audio Design

(Continued from page 48)

CLASS-B A.F. MODULATOR

D.c. plate voltage	1000 volts
Load resistance (plate-to-plate)	6400 ohms
Max. av. d.c. plate current (2 tubes)	317 ma.
Power output (2 tubes)	200 watts

From this information we wish to get two figures of vital importance which are not given. We want the recommended peak plate current and the drop across the tube at that current. With that information we can calculate the maximum output obtainable at the plate voltage available, together with the optimum reflected load impedance; or, if that output is greater than is necessary, the proper operating conditions for the required output may be obtained.

The peak plate current to one tube may be obtained by dividing the maximum average plate current (with sine wave input) to both tubes by 0.636. $317/0.636=0.5$ ampere. This value should never be exceeded.

The drop across the tube is obtained indirectly by subtracting the voltage developed across R_p from the supply voltage. With a plate-to-plate load of 6400 ohms the reflected load impedance to one tube would be $6400/4$ or 1600 ohms. With a peak plate current of 0.5 ampere, the peak developed voltage would be 0.5×1600 , or 800 volts. With a supply voltage of 1000, the drop across the tube therefore must be 200 volts. The following formula should be used:

$$U.P.O. = \frac{(I_{p_{max}}) \times E_{R_p}}{2}$$

Suppose the power supply available for the modulators delivers only 900 volts.

$$\text{(Case 1) } U.P.O. = \frac{0.5 \times (900-200)}{2}$$

$$U.P.O. = \frac{0.5 \times 700}{2}$$

= 175 watts

The optimum value of reflected load impedance would be $700/0.5=1400$ ohms for one tube, or 5600 ohms plate-to-plate.

If the power supply delivered 1100 volts, the calculations would be

$$\text{(Case 2) } U.P.O. = \frac{0.5 \times (1100-200)}{2}$$

$$= \frac{0.5 \times 900}{2}$$

= 225 watts

The optimum value of reflected load impedance would be $900/0.5=1800$ ohms for one tube, or 7200 ohms plate-to-plate.

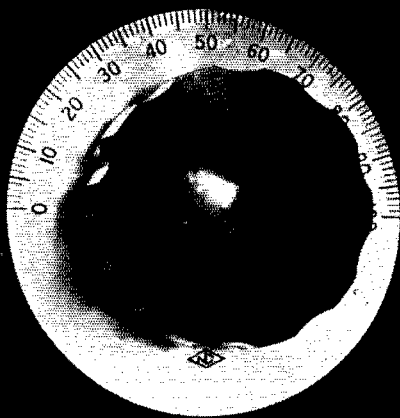

TYPE O DIAL

The National Type O Dial is definitely a handsome piece of equipment. The circular-grained, solid nickel-silver dial is 3 1/2 inches in diameter. Numerals and division lines are clean-cut and accurate. The large bakelite knob is well proportioned and comfortable to the hand. For safety, the dial is positively insulated from the hub by a large bakelite boss. Ask to see the National Type O Dial at your dealers.

NET PRICE
\$.90

NATIONAL COMPANY, INC., MALDEN, MASS.

LEARN RADIO

— TELEVISION —

New Beginners' Class Sept. 13th. Send for 48-page catalogue, explains fully, 500 licensed graduates placed in last six years in broadcasting, shipping, police radio, aviation, etc. Oldest, largest and best equipped school in N. E. We teach all branches of radio. Tel. HAN. 8184.

Ten operators placed with Pan-American Airways in one week.

Radio Service Instructions Given

Open All Summer

MASS. RADIO SCHOOL
18 Boylston Street, Boston

Quicker than a short circuit *Littelfuse*

Increase the efficiency of your equipment by using INSTRUMENT LITTELFUSES. All types of fuses and mountings from world-famous factory. HI-VOLT LITTELFUSES for transmitters, etc., 1,000, 5,000 and 10,000 volt ranges, 1/16 amp. up. INSTRUMENT LITTELFUSES for meters 1/200 amp. up. RADIO FUSES, AUTO FUSES, etc. You should know about Littelfuses. See your dealer or write for catalog.

LITTELFUSE LABS. 4246 Lincoln Ave. Chicago, Ill.

QUARTZ CRYSTALS

ALL TYPES. Low Temperature Coefficients. X and Y cuts Holders. Ground to any practical specifications.

Write for complete particulars

Bellefonte Radio Eng. & Mfg. Co.
BELLEFONTE, PA.

For **EFFICIENT**
MORE Results



Use **C-D DYKANOL CAPACITORS**

Type TJ

The really practical and economical capacitor designed for amateur use. Yet, you will find them in leading broadcast transmitters because of their outstanding electrical characteristics.

Check these exclusive features and be convinced —

- Hermetically sealed in welded steel containers.
- Dykanol impregnated and filled.
- Can be operated at 10% above voltage rating without injury.
- Unaffected by climatic conditions.

Built for lasting satisfaction and dependability by the world's largest and oldest capacitor manufacturer. For complete details write for catalog 137 A.



CORNELL-DUBILIER CORPORATION
SOUTH PLAINFIELD • NEW JERSEY

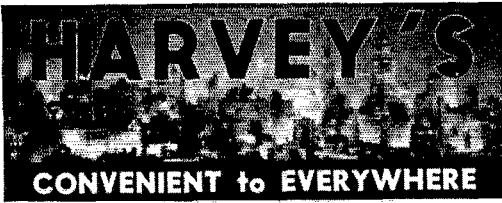

When in New York, visit our newly decorated and enlarged store . . . listen to all the new radio sets, see the latest developments . . . You are especially invited to inspect our new Camera Department. Should you have photographic equipment that you are anxious to trade in, we will offer liberal allowances on purchases of radio apparatus. Details can be furnished by mail.

NEW SKY RIDER SUPER RECEIVER

1938 model — 5 meter operation — minimum image trouble — R meter — variable selectivity . . . At the sensational low price (less crystal and speaker) of . . . **\$99**

Now you can own a real OSCILLOSCOPE with a large clear 3" tube (more than 7 square inches of screen). Completely equipped with amplifiers on horizontal and vertical plates . . . Perfect synchronization control at any frequency . . . A host of **\$54.50** other features . . .

Famous nine feature Dunco relays, in stock, each . . . **\$2.00** Today's leading low-priced, low-powered tube.

Brush Transfilter for useful selectivity. . . **\$5.88** **TAYLOR T-20 \$2.45**

One of the finest mobile power supplies on the market . . . Electronic Power Pack — 300 volts — 100 ma. Perfectly filtered for 5 meter work. . . . **\$13.50**

Complete "Get Started" outfit (Key, high frequency buzzer, battery and instructions). . . . **\$1.98**

The Value of the Month

THREE-STAGE TRANSMITTER FOR ALL BAND OPERATION. Complete kit as described on page 22 of the June QST. Punched and drilled chassis. Specified Cardwell condensers, Bud condensers, Taylor tubes, National coil forms, UTC transformers, IRC resistors, Isolantite sockets, Sangamo condensers. **\$39.95** Ready to wire, less tubes and crystal . . .

OUR *Best* VALUE IS OUR RECORD OF LOYAL SERVICE

HARVEY

Radio Company of New York

103 WEST 43rd STREET • NEW YORK, N. Y.

CABLE ADDRESS: "HARADIO"

Suppose we had 250 watts input to the modulated amplifier, in which case we would require only 125 watts from the modulator. Assuming a modulator plate voltage of 1050

$$\text{(Case 3)} \quad 125 = \frac{I_{p_{max}} \times (1050 - 200)}{2}$$

$$125 = \frac{850 \times I_{p_{max}}}{2}$$

$$I_{p_{max}} = \frac{250}{850}$$

$$I_{p_{max}} = 0.294 \text{ amp. peak plate current}$$

$$850 / 0.294 = 2900 \text{ ohms } R_p \text{ or } 11,600 \text{ ohms plate-to-plate.}$$

If the turns ratio of the transformer is known, the calculations need not be made in terms of impedance but may be made directly in terms of voltage ratios. The turns ratio may be taken directly from the impedance ratio and is the square root of the impedance ratio. A transformer with an impedance ratio from secondary to total primary of $\frac{5}{8}$ would have a turns ratio of $\sqrt{\frac{5}{8}} = \sqrt{0.625} = 0.79$. This ratio is for the whole primary; the ratio from secondary to one-half primary would be 2×0.79 or 1.58.

In Case 1, we were able to develop 700 volts across R_p , which is half the primary, so the peak voltage across the secondary will be $700 \times 1.58 = 1106$ volts. The modulated amplifier plate voltage will always work out to be 1106 volts so long as the modulator plate voltage is 900 and the same transformer ratio and modulator tubes are used. The modulator will deliver 175 watts of audio so the input to the modulated amplifier could be a maximum of 350 watts. At 1106 volts, the plate current to the modulated amplifier should be $350 / 1106 = 316$ ma.

In Case 2, we were able to develop 900 volts across R_p , or one-half primary. $900 \times 1.58 = 1422$ volts across the secondary. The audio output is 225 watts, so the input to the modulated amplifier may be a maximum of 450 watts. $450 / 1422 = 316$ ma. modulated amplifier plate current.

In making the calculations only one precaution need be observed, namely that the input to the modulated amplifier must not exceed twice the audio output of the modulator. If more input is applied to the modulated amplifier, the plate voltage and current should be increased in proportion. Of course, 100 per cent modulation without distortion cannot be realized with appreciably greater inputs. If less input is desired the plate voltage should be maintained at the calculated value but the plate current may be decreased. This will increase the modulated-amplifier load impedance and also the reflected load impedance to the modulators. However, as the input to the amplifier is reduced less audio is required, and under these conditions the reflected load impedance *should* be increased, and it will increase in

**Radio Operator's
Course**
Complete in
**Telegraphy—
Telephony**

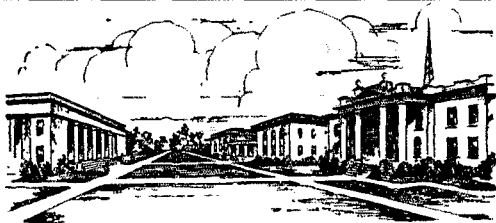

**Practical
Experience
Studio—
Transmitter—
Announcing**

AVIATION RADIO A new complete training embracing advanced work for amateurs, or operators—twelve months' study required for the average amateur to graduate—excellent opportunity for men interested in commercial airlines. Applicant for enrollment must be high school graduate, or college student. We confer degree—Science of Radio—to graduates of this course. If interested, write for aviation radio details.

P. A. C. is an endowed, educational institution— not privately owned, not operated for profit, college rank maintained. Course consists of maximum knowledge necessary to secure Commercial Telegraph Second-class, and Radio-telephone First-class government licenses. Course includes Wireless Code, Radiophone, Announcing, Microphone-Studio Technique, Service, Television, Police, and Aeronautical Radio. We are authorized to teach RCA texts. At the completion of course you receive practical studio technique experience in our commercial broadcast studios located in the administration building, and experience as an operator on K P A C (500-Watt Commercial transmitter located on the campus, owned and operated by the college), and inter-departmental marine communication experience.

If interested, write for Bulletin R

PORT ARTHUR COLLEGE

PORT ARTHUR (World-known port) TEXAS

VALPEY CRYSTALS

- Type VM2A Mounted 1.7 3.5 7 Mc. bands drift less than 4 cycles supplied within 5 kc. of frequency specified. **\$4.50**
- Type VM2 Mounted 1.7 3.5 7 Mc. bands drift less than 15 cycles supplied within 5kc. of frequency specified. **\$3.00**
- Type VM2SS Mounted Single signal filter crystal 456 465 500 and 525kc. **\$4.60**
- Type VC2 Unmounted 1.7 3.5 7 Mc. bands drift less than 20 cycles supplied within 5kc. of frequency specified. **\$2.25**
- Type VC2 Unmounted 1.7 3.5 Mc. bands only within 20kc. of frequency specified. **\$1.50**
- Type VCH Mounting For use with 1 inch 160 80 and 40 meter crystals. Specify frequency to be used. **\$3.90**
- Type LW20 Mounted 14 to 15 Mc. supplied within 20kc. of frequency specified. **\$5.90**

We are equipped to supply crystals for commercial use or any special application

Order direct or purchase from your dealer

THE VALPEY CRYSTALS

377 Summer Street Medway, Mass.

**110 VOLTS AC
Anytime! Anywhere! With
KATOLIGHT PLANTS**

- 850 Watts AC and 6 Volts DC - **\$39.60**
 - 850 Watts AC and 6 Volts DC - **\$20.00**
 - 1000 Watts AC and 18-32 Volts DC **\$94.00**
- Portable—Self-Cranking
Ask for Special Discount to Amateurs
300 watt 110 v. AC Generator only **\$19.95**
6, 12, 32 and 110 volt Rotary Converters.
AC/DC and DC Generators, Etc., etc.

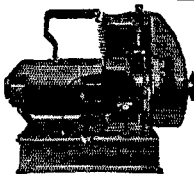

Write for Details
KATO ENGINEERING COMPANY
Mankato, Minnesota, U.S.A.

SOLD BY ASTATIC JOBBERS

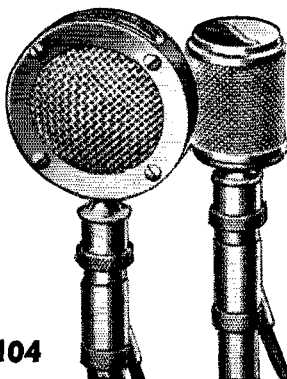

A crystal microphone designed for voice transmission and general purpose P.A. installations. Output level -54 DB (conservatively rated). Equipped with interchangeable plug and socket and cable protector. List price..... **\$29.50**

Wide range, non-directional crystal microphone. Interior assembly two dual diaphragm high fidelity units. Equipped also with interchangeable plug and socket and cable protector. New low list price..... **\$27.50**

Licensed under Brush Development Co. Patents

ASTATIC MICROPHONE LABORATORY, INC.
DEPT. Q, YOUNGSTOWN, OHIO, U. S. A.
Pioneer Manufacturers of Quality Crystal Devices

Improves Your 'Fist'
Cuts Effort in Half
Insist on The Genuine Martin
VIBROPLEX

SEMI-AUTOMATIC KEY

*Simply press lever—
machine does the rest*

**JUNIOR
ONLY
\$12.50**

Small and more compact. Large contact points. Black japanned base. A low priced key with world famous Vibroplex Quality. Other models, \$17 and \$19.

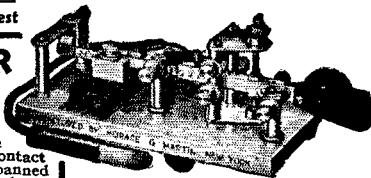

Vibroplex's machine speed, superior signal and effortless operation assures the user the fastest, best and easiest way to send. Experienced operators know this—that's why over 100,000 of them use only the Vibroplex key.

Faster than the fastest hand sender—less than half the effort. Easy to learn. Easy to use. Easy to own. Order to-day! Insist on the Genuine Martin Vibroplex key. Accept no substitute. Liberal allowance on old Vibroplex. Money order or registered mail. Write for FREE illustrated catalog just off the press.

**FREE
CATALOG**



THE VIBROPLEX CO. Inc.
832 Broadway New York, N. Y.

**ultra-
high**

"5-10" RECEIVER

- Tuned R.F. and Controlled Super-Regeneration 5 & 10 meters
- 4 Metal Tubes
- 5 inch Dynamic Speaker
- Only 9¾" x 6¾" x 5" overall.

IDEAL FOR MOBILE
INSTALLATION

\$28.00

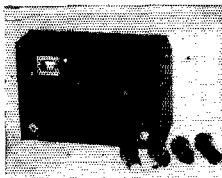

5 Meter Duplex Transmitter-Receiver

"Type TR-6A6"

- Non-radiating Rec'vr
- 7 Tubes — 5" Dyn. Speaker
- 6E6 Unity Coupled
- 10 watt Carrier
- 100% Modulation
- Duplex Operation — PHONE ● MCW

TRANSMITTER—
RECEIVER

\$47.70

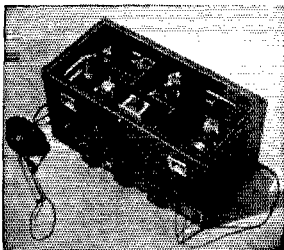

RADIO TRANSEIVER LABORATORIES

8627 — 115 Street, Richmond Hill, New York

**LYNCH
GIANT KILLER CABLE**

For any and all types of radio frequency transmitting and receiving systems.

Not only endorsed by, but used by leading radio experts everywhere.

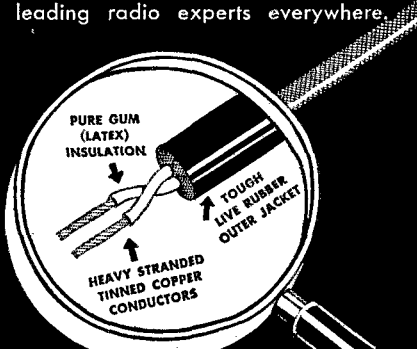

World's Largest Makers of Antenna Systems

L. S. BRACH Mfg. Corp.

Newark, N. J.



Est. 1906

exactly the correct proportion. Perhaps this will be more readily understood if one considers that for a given tube and value of plate voltage, the developed voltage across R_p will be approximately the same for all values of current below filament saturation, and if the ratio of the transformer is not changed the voltage across the secondary will be the same. This is not strictly true because at lower values of plate current the drop across the tube will be slightly less. The difference is small and need not be taken into consideration for amateur applications.

GENERAL CONSIDERATIONS

One of the commonest questions asked is "What should the meter read?" The question has no definite answer when voice input is used. The current value we have been dealing with in making calculations is a peak value which never shows up on any meter. In setting the ratings for Class-B audio, an average value is stated. This is what the meter would read with sine-wave input, and is determined by multiplying the peak value by 0.636. In other words, the average value with sine-wave input for two tubes is 0.636 of the peak value for one tube. However, with voice input, because of the difference in wave form the same peak output and peak plate current are realized at much lower average values of plate current. Usually the average plate current with voice input is approximately 50 per cent of the value for sine-wave input at the same peak output. Only an oscilloscope will give a correct answer to the question, "What should the meter read?"

In calculating operating conditions, the information presented herewith must be tempered with good judgment. From the figures only it might seem possible to take a pair of 10's and transformers designed for use with them and by raising the plate voltage high enough modulate a kilowatt. However, it cannot be done.

The peak voltage from plate to filament will be the applied voltage plus the developed voltage. For instance, if the applied voltage is 1000 and the developed voltage 800, the peak voltage from plate to filament would be 1800 volts. The voltage from plate to grid would be greater by the amount of the peak grid voltage plus the bias, which would be approximately the drop across the tube, say 200 volts. Thus the peak voltage from plate to grid would be about twice the supply voltage. Consequently, the applied voltages should be in line with the maximum voltage ratings of the tubes or breakdown may be experienced.

Best transformer design involves the use of as small a core window as possible to accommodate the required amount of insulation and wire, and the minimum amount of insulation should be used to permit the tightest possible coupling between windings. For this reason, audio transformers use the least amount of insulation which will provide a reasonable safety factor. Consequently, if the voltages across the transformer are increased above the values for which it was designed, the

(Continued on page 106)

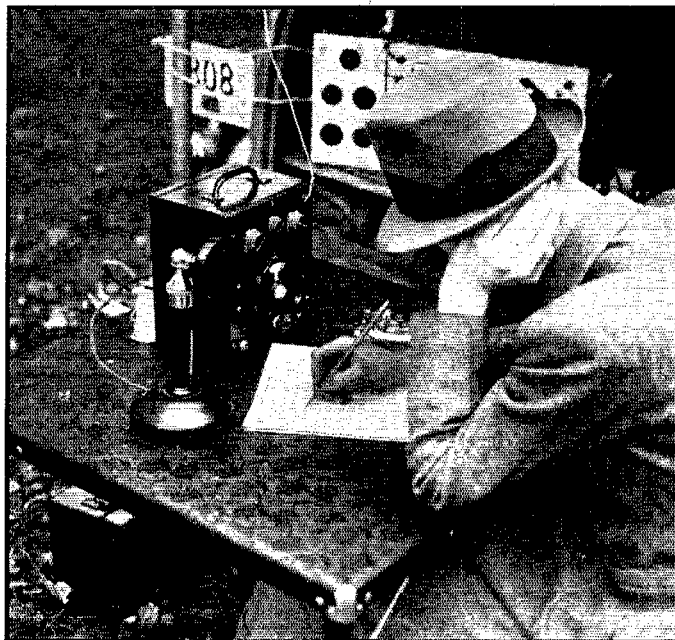

HAVE YOU A LOG

for your
Portable
and Mobile
operation?

35c each
3 for \$1

A.R.R.L.
West Hartford, Conn.

"Put Your Signal Where You Want It When
You Want It There"

MIMS SIGNAL SQUIRTER

ROTARY BEAM ANTENNAS

20 and 14 Meters Only

Listen for—or see them at W4DLH, W2JKQ, Vc3LL,
W4EDD, W9DN, W8MXD, W8FHJ, W9RGH,
W9BHT, W2FAM, W5AGF, W4OC, W9ZDO and
W5BDB. Send 5c for information.

MIMS RADIO COMPANY

M. P. MIMS—W5BDB, P. O. Box 504, Texarkana, Ark.

GULF RADIO SCHOOL

Radiotelegraphy

Radiotelephony

Radio Servicing

SECOND PORT } 1007 Carondelet Street
U. S. A. } NEW ORLEANS, LA.

Unconditionally
Guaranteed

**PR
CRYSTALS**

Powerful
Reliable

X cut 7000 KC ± 5 KC . . \$1.85 3500 or 1750 . . \$1.65
Low Drift ± 5KC 40-80-160 2.20

PETERSEN RADIO CO.
COUNCIL BLUFFS, IOWA
Formerly Omaha Crystal Labs.

SMALL SIZE WITH TOP PERFORMANCE

NEW V-1 VELOCITY MICROPHONE

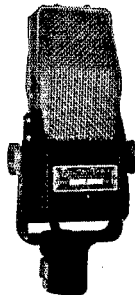

- The Smallest High-Fidelity Velocity Microphone
- Zero Cavity Resonance
- Integral Shock Absorber
- Cable and Connector
- Dependable — Suitable for Tropical Service
- Thoroughly Hum-Free
- The new V-1 has all the features of microphones in the higher priced brackets.

SEE YOUR JOBBER
Write for Catalog

LIST
PRICE **\$25**

ELECTRO-VOICE
MANUFACTURING COMPANY
326 E. Colfax Ave., South Bend, Indiana
Export Office: 100 Varick St., New York, N. Y.

Where to buy it

A directory of suppliers who carry in stock the products of these dependable manufacturers.



ALBANY, N. Y. Uncle Dave's Radio Shack 356 Broadway
BALTIMORE, MD. Radio Electric Service Company 3 North Howard St.
BOSTON, MASS. Radio Shack 46 Brattle Street
HARTFORD, CONN. Radio Inspection Service Co. 227 Asylum Street
NEWARK, N. J. Wholesale Radio Service Co., Inc. 219 Central Ave.
NEW YORK, N. Y. Gross Radio, Inc. 51 Vesey St.
NEW YORK, N. Y. Harrison Radio Co. 12 West Broadway
NEW YORK, N. Y. Wholesale Radio Service Co., Inc. 100 Sixth Ave.
NEW YORK, N. Y. Terminal Radio Corp. 80 Cortlandt Street
POTTSVILLE, PENN. E. Norwegian & George Sts. Sylvester Radio & Supply Co., Inc.
READING, PENN. George D. Barbey Company 404 Walnut St.
READING, PENN. 104 North Ninth Street Sylvester Radio & Supply Co., Inc.
SPRINGFIELD, MASS. T. F. Cushing 349 Worthington St.
WASHINGTON, D. C. 938 F Street, N. W. Sun Radio & Service Supply Co.

BALTIMORE, MD. Radio Electric Service Company 3 North Howard St.
BOSTON, MASS. H. Jappe Company 46 Cornhill
BOSTON, MASS. Radio Shack 46 Brattle Street
BURLINGTON, VERMONT Vermont Hardware Co., Inc.
CAMDEN, NEW JERSEY Radio Electric Service Company 811 Federal Street
GREENWICH, CONN. Mead Stationery Company 252 Greenwich Ave.
HARTFORD, CONN. Radio Inspection Service Co. 227 Asylum Street
MONTREAL, CANADA Canadian Electrical Supply Co., Ltd. 285 Craig Street, West
NEWARK, N. J. Wholesale Radio Service Co. 219 Central Avenue
NEW YORK, N. Y. Bruno-New York, Inc. 460 W. 34th St.
NEW YORK, N. Y. Sanford Samuel Corp. 136 Liberty St.
NEW YORK, N. Y. Wholesale Radio Service Co. 100 Sixth Avenue
NEW YORK, N. Y. Harrison Radio Company 12 West Broadway
NEW YORK, N. Y. Grand Central Radio, Inc. 124 E. 44th Street
PHILADELPHIA, PENN. Eugene G. Wile 10 S. 10th Street
PHILADELPHIA, PENN. Raymond Rosen & Company 117 North 7th St.
PHILADELPHIA, PENN. M & H Sporting Goods Company 512 Market Street
PHILADELPHIA, PENN. Radio Electric Service Company 3145 N. Broad Street
PHILADELPHIA, PENN. N.E. Corner 7th & Arch Streets Radio Electric Service Company
POTTSVILLE, PENN. E. Norwegian & George Sts. Sylvester Radio & Supply Co., Inc.
READING, PENN. Bright & Company 8th & Elm Streets
READING, PENN. 104 North Ninth Street Sylvester Radio & Supply Co., Inc.



ALBANY, N. Y. Uncle Dave's Radio Shack 356 Broadway

Where to buy it

A directory of suppliers who carry in stock the products of these dependable manufacturers.

SPRINGFIELD, MASS. T. F. Cushing 349 Worthington Street

SPRINGFIELD, MASS. S. S. Kresge Radio Department 1540 Main Street

WASHINGTON, D. C. Sun Radio & Service Supply Co. 938 F Street, N. W.

BOSTON, MASS. Selden Radio Company 28 Brattle Street

BUFFALO, NEW YORK Radio Equipment Corp. 326 Elm Street

CONCORD, NEW HAMPSHIRE Carl B. Evans 80 N. State Street

NEWARK, NEW JERSEY Wholesale Radio Service Co. 219 Central Street

NEW YORK, N. Y. Harrison Radio Company 12 West Broadway

NEW YORK, N. Y. Wholesale Radio Service Co. 100 Sixth Avenue

WASHINGTON, D. C. Sun Radio & Service Supply Co. 938 F Street, N. W.

RME
RECEIVERS - PRE SELECTORS
AMATEUR RADIO EQUIPMENT
RADIO MFG. ENGINEERS, Inc.
PEORIA ILLINOIS

ALBANY, NEW YORK Uncle Dave's Radio Shack 356 Broadway

BINGHAMTON, NEW YORK Radio Testing Station 25-27 Sturges Street

BUFFALO, NEW YORK Dymac Radio 216 E. Genessee Street

HARTFORD, CONNECTICUT Stern Wholesale Parts Company 210 Chapel Street

NEW YORK, N. Y. Harrison Radio Company 12 West Broadway

NEW YORK, N. Y. Terminal Radio Corp. 80 Cortlandt Street

ROCHESTER, NEW YORK Radio Service Shop 244 Clinton Ave., N.

WASHINGTON, D. C. Upshur Radio Company 1837 Vernon St., N.W.

TRIPOLET
INSTRUMENTS

ALBANY, N. Y. Uncle Dave's Radio Shack 356 Broadway

BOSTON, MASS. Radio Shack 46 Brattle Street

BOSTON, MASS. Selden Radio Company 28 Brattle St.

MONTREAL, CANADA Canadian Electrical Supply Co., Ltd. 285 Craig Street, West

NEWARK, N. J. Wholesale Radio Service Company 219 Central Ave.

NEW YORK, N. Y. Wholesale Radio Service Company 100 Sixth Avenue

POTTSVILLE, PENN. E. Norwegian & George Sts. Sylvester Radio & Supply Co., Inc.

READING, PENN. George D. Barbey Company 404 Walnut Street

READING, PENN. Sylvester Radio & Supply Co., Inc. 104 North Ninth St.

WASHINGTON, D. C. Sun Radio & Service Supply Co. 938 F Street, N. W.

RAYTHEON
AMATEUR TUBES

ALBANY, NEW YORK Uncle Dave's Radio Shack 356 Broadway

BOSTON, MASS. The Radio Shack 46 Brattle Street

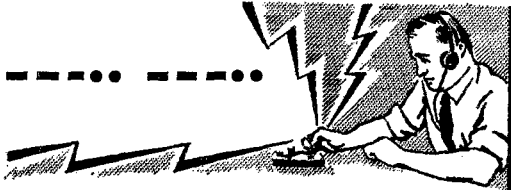

Class B Audio Design

(Continued from page 102)

safety factor will be reduced. Increasing the voltage across the windings also adversely affects the low frequency response, though this is a less important consideration because the low-frequency cut off for most transformers is below the lowest frequencies obtained with voice input. The amount of d.c. through the secondary should not exceed the maximum rated value because it may result in core saturation, which necessarily must cause high harmonic content. In general, for safe operation, the voltages across and the currents through the windings of the transformer should be in line with those at which the transformer was intended to operate.

If the calculations are to be made for four tubes in push-pull parallel Class-B, the permissible peak plate current would be doubled. The drop across the tube or tubes would remain the same, as would the voltage developed across R_p . Twice the output may be obtained from four tubes as from two.

How're the wife and kids?

Sounds like part of a typical ham QSO doesn't it? . . . but, we're serious. You may be satisfied with your job, but is the xyz? Perhaps, you're not earning enough to put an "x" in front of your "yl." If you have the desire to improve your position in Radio, CREI can show you the way.

OUR ONE YEAR RESIDENCE COURSE IN PRACTICAL RADIO ENGINEERING

— is no "snap" course, but for the Radioman who is serious about the business of getting ahead, it can help him as our training has helped so many others. A post card mailed to us will bring you our 48-page "Tested Plan." It explains how you can accomplish your ambition to work toward the top in professional radio.



E. H. Rietzke, Pres.

Write Today for the Free Booklet "A Tested Plan for a Future in Practical Radio Engineering."

CAPITOL RADIO ENGINEERING INSTITUTE

WASHINGTON, D. C. Dept. Q-8 NEW YORK CITY 29 Broadway
14th and Park Road



5500 R. R. JOBS FOR CW MEN WHO PREPARE THEMSELVES

■ AVAILABLE SOON ■

No license required. Eight hours per day. Year around. 65 to 80 cents per hour. If you can copy 15 words per minute, write

CODE-CRAFT Q 6703 Dunham Ave. CLEVELAND, OHIO



NEW HOLDER DESIGN

15 SECONDS TO INSTALL CRYSTAL

For All Bands

GREATER STABILITY
Plugs in 5 prong tube socket

Beautiful Appearance

MODEL AH HOLDER \$1.00 At your dealer or direct

HIPOWER LOW DRIFT CRYSTALS:
within 10 kc. or Choice of stock

AH-10, 1700-3500 Kc. bands \$2.35

AH-10, 7000-7300 " band 3.90

WRITE FOR NEW LITERATURE

Hipower "Low Drift" Broadcast and Commercial Crystals Are Approved by F.C.C.

Hipower Crystal Co., 2035 Charleston St., Chicago

YOU ARE INVITED TO INVESTIGATE THE MANY ADVANTAGES OFFERED BY

EASTERN RADIO INSTITUTE

899 BOYLSTON STREET, BOSTON, MASS.

Rocky Mountain Division Convention

Colorado Springs, Colo., September 4th-5th

WHO will ever forget the Cave of the Winds? Yes, the Pike's Peak Amateur Radio Association is sponsoring the annual divisional convention which will be held at Colorado Springs, September 4th and 5th. Technical talks, equipment demonstrations, Army-Navy meetings, Novelty stunts, YL's theatre party, Picnic at Stratton Park, and of course a big banquet. Write C. E. Hathaway, Secretary, 1512 North Corona, Colorado Springs, Colo., for further information.

Roanoke Division Convention

Richmond, Va., September 4th-5th

ALL roads will be leading to Richmond and all hams will be trekking the highways for the 1937 official divisional convention if rumors are to be believed. Richmond Short Wave Club is sponsoring the convention to be held at the new John Marshall Hotel on September 4th and 5th. A program of special interest is being worked out—just watch for the publicity. President Woodruff, Major Hawthorne USMC and Commander Rogers USN will be present. There is a possibility that Secretary K. B. Warner will make the trip. A surprise will be sprung on the gang during the convention. R. N. (Bob) Eubank, 2817 Montrose Ave., Richmond, Va., is the chairman and will gladly give further information on request.

HAM-ADS

(1) Advertising shall pertain to radio and shall be of nature of interest to radio amateurs or experimenters in their pursuit of the art.

(2) No display of any character will be accepted, nor can any special typographical arrangement, such as all or part capital letters be used which would tend to make one advertisement stand out from the others.

(3) The Ham-Ad rate is 15¢ per word, except as noted in paragraph (6) below.

(4) Remittance in full must accompany copy. No cash or contract discount or agency commission will be allowed.

(5) Closing date for Ham-Ads is the 25th of the second month preceding publication date.

(6) A special rate of 7¢ per word will apply to advertising which, in our judgment, is obviously non-commercial in nature and is placed and signed by a member of the American Radio Relay League. Thus, advertising of bona fide surplus equipment owned, used and for sale by an individual or apparatus offered for exchange or advertising inquiring for special equipment, if by a member of the American Radio Relay League takes the 7¢ rate. An attempt to deal in apparatus in quantity for profit, even if by an individual, is commercial and takes the 15¢ rate. Provisions of paragraphs (1), (2), (4) and (5) apply to all advertising in this column regardless of which rate may apply.

Having made no investigation of the advertisers in the classified columns, the publishers of *QST* are unable to vouch for their integrity or for the grade or character of the products advertised.

QUARTZ—direct importers from Brazil of best quality pure quartz suitable for making piezo-electric crystals. Diamond Drill Carbon Co., 719 World Bldg., New York City.

RADIO engineering, broadcasting, aviation and police radio, servicing, marine and Morse telegraphy taught thoroughly. All expenses low. Catalog free. Dodge's Institute, Byrd St. Valparaiso, Ind.

NATIONAL—Hammarlund, RCA-RME used sets, 60% off list. W3DQ, 405 Delaware Ave., Wilmington, Del.

QSL'S, W2SN, Helmetta, N. J.

CALLBOOKS—new DX calls, new prefixes, thousands of new W and VE calls, in the Fall, 1937 Radio Amateur Call Book. Sent postpaid \$1.25, or a whole year (four issues) for \$4. (In foreign countries \$1.35 and \$4.35.) Your call and QRA printed in large type \$1 per year. Radio Amateur Call Book, 610 S Dearborn, Chicago.

TELEGRAPH speed keys in kit form, only \$2.89. A post card brings full information, Electric Specialty Mfg. Co., PO Box 645 Cedar Rapids, Iowa.

QSL'S—Designy our own—New process—Better and cheaper. Write for free kit. QSL Company, Box 481, Hartford, Conn.

COMPLETE training for all amateur and professional radio licenses. New York Wireless School, 1123 Broadway, N. Y.

GENERAL Electric dynamotors 24 volts to 750 200 mills. \$25. Two machines for 1500 volts \$20 each, 500 watts 500 cycles, \$10; slightly used, \$6. Westinghouse 27½/350, \$10. 6-15 volts 500 watts with propeller. \$10. 200 watt 900 cycles. \$15. List. Henry Kienzie, 215 Hart Blvd., Staten Island, N. Y.

QSL'S. Better designs; better stock; better workmanship. Free samples to hams only. W2FJE, 143 DeKalb Ave., Brooklyn, N. Y.

QSL'S—2 color—\$1. hundred. Samples. Stamp. W8NOS.

QSL'S, all colors, cartoons, snappy service. Write for free samples today. W1BEF, 16 Stockbridge Ave., Lowell, Mass.

SELL—three transformers—2300 volt 1350 watt, \$16; 800 volt and 500 volt 350 watt, \$3.50; R. Laursenon, 812 Coal, Wilkensburg, Pa.

QSL'S. Samples. Stamp. Printer, Corwith, Iowa.

CRYSTALS: A cut, 80-160 meters, within one kc., \$1.95. Guaranteed strong oscillators. Vollmer Radio Lab., Rt. 8, Box 72, Portland, Ore.

QSL'S. Cartoons. Free samples. Theodore Porcher, 7708 Navaajo St., Philadelphia, Pa.

FOR sale: beautiful 200 watt c.w. station. Seven Weston meters. Receiver, tubes, xtal. Finest parts used. Complete—\$215. Robert Freeman, Adel, Iowa.

QSL'S, SWL's. Patronize a real ham. Free samples. W8DED, Holland, Mich.

COLLINS 30FXC and 400 watt phone-cw rig for sale. Make cash offer. No shipments. Come and get them. W8IKE.

SALE: 1936 Super Skyryder SX9 guaranteed good condition. E. Hatch, Box 691, Hyannis, Mass.

RECEIVERS—RME-69, ACR-136, Tobe, FB7A Super Skyryder. Reconditioned. Bargains. Mims Radio Co., Texarkana, Ark.

SELL or swap 500 watt 60 cycle 120 volt automatic clutch Esco generator. Also 32 volt 110-60 cycle converter Janette. J. Peckham, 24 Case Ave., Auburn, N. Y.

WRITE for big list of new and used equipment—Weston Model 1 meters; keys, 50¢; RCA-210's, brand new, 95¢; used Collins 4A, \$35; W. E. double button mike, \$7; Mae L. Trautman, 35 Ellis Ave., Irvington, N. J.

QSL'S, SWL's—100—3 color, 75¢. Lapco, 344 W. 39th, Indianapolis, Ind.

QST and IRE Proceedings, Vol. 1, No. 1, to date. Desire cash offers, complete sets, only E. L. Powell, 325 Emerson, N.W., Washington, D. C.

QSL'S. Finest at lowest prices. Maleco, 1612 Eastern Parkway, Brooklyn, N. Y.

REPLACED and new equipment—prices less than wholesale. Write for bulletin today. Martin, KRQA, Santa Fe, New Mexico.

QSL'S. 300 one-color cards, \$1. Samples. 2143 Indiana Ave., Columbus, Ohio.

CRYSTALS: Eidson T9 fracture resisting 40 and 80 meters, \$1.60 postpaid. Dependable, powerful X cut. Close frequency always supplied. Fully guaranteed, accurately calibrated. Compare the activity or output with any type cut at any price—you be the judge. T9 superlapped ceramic plugin holders, \$1.10 postpaid. C.O.D.'s accepted. Eidson's, Temple, Texas.

QSL'S. Special designs. Samples. Quality Printers, Parsons, Kansas.

AUTO keying hand wanted, Creed or Boehme. State condition and price. WICEJ, 545 Camden St., Devon, Conn.

QSL'S—Highest quality, lowest prices. Radio Headquarters, Ft. Wayne, Ind.

CRYSTALS: Zero out. Guaranteed to compensate at near zero without oven. 80-160 meters, \$1.85. Forty meters, \$2. Holders, 75¢ postpaid. Small crystals, \$1. Blanks, 50¢. Fisher Lab., 4522 Norwood St., San Diego, Cal.

SELL: Super Skyryder SX11—perfect shape, used three months \$75. T200 tubes new \$18 list other parts. W8ESEY, Hellam, Pa.

SARGENT IIMA, 9.5 to 3,750 meters. A-1, nearly new. Cash, \$25. W4AJH.

TRANSMITTER—factory built special Lafayette PB46A using 6L6G's final—90 watts, all bands, fone, c.w.—\$150. Worked Europe, Africa, Hawaii ten meter phone. Heckman, 1928 East 23rd St., Brooklyn, N. Y.

TELEPLEXES, instructographs, omnigraphs, vibroplexes, meters bought, sold. Ryan's, Monroe City, Mo.

CRYSTALS, X cut, 160-80 meters. Exact specified frequency, \$2.50. Within five kilocycles, \$1.50. Stock crystals, close to desired frequency, \$1.25. Three 80 meter, semi-finished blanks, including carborundum, \$1.20. Plugin holders, 85¢. William Threm, W8FN, 4021 Davis Ave., Cheviot, Ohio.

CASH or trade any type transmitting tubes. W2AWZ, Dobbs Ferry, N. Y.

NEW. Write for circulars describing new economical transmitter kits with inputs varying from 25 to 1000 watts, at prices you can afford to pay. Please state your requirements. W8ANT.

RECEIVER headquarters. W8ANT.

RME69'S and **DB20'S** in stock. W8ANT.

1938 Super Skyryders in stock. W8ANT.

USED receivers. W8ANT.

UTC amateur specials in stock. W8ANT.

ALL lines of new and used amateur equipment bought, sold, exchanged. Write to Southern Ohio's only amateur owned amateur business. Jos. N. Davies, W8ANT, 2767 N. Bend Rd., Sta. A, Cincinnati, Ohio.

CRYSTALS: Within ten kilocycles. X cut: 80M, \$1.50. V cuts: 80M, \$2.25. 160M, \$2.50. 40M, \$3. Unconditionally guaranteed. Low-priced mounted units. Holders. Request catalog. Ham Crystals, 1104 Lincoln Place, Brooklyn, New York.

SELLING out parts for 1,000 watt CW xmitter. Includes following: Thordarson transformers; National, Cardwell and Hammarlund condensers; Sanagamo condensers; Taylor tubes; Triplet and Weston meters. Also 5 meter transceivers, one new (used less than 5 hours) Clough-Brengle CRA oeillograph with the OM modulator and signal generator. Perfect condition. Both for \$100. Many other parts. Send for complete list and prices. W4DQI, 14'S. Side Ave., Mooresville, N. C.

GLASS drills, guaranteed to work. Large size, drills up to five-sixteenth holes, 75¢ prepaid. Small size, drills up to three-sixteenth holes, 60¢ prepaid. W8SVH.

CRYSTALS, Eidson's 40 and 80 meters, \$1.60. High output holders, \$1.10. Hieronymus, 88-34 209 St., Bellaire, N. Y.

ULTRA Skyryder with crystal practically brand new, \$79.50. Other bargains. Hall, Box 2434, Houston, Texas.

ALUMINUM call letter plates. Raised letters 1/8" or 1/4". \$1. postpaid. Wise, W9YCF, Auburn, Ind.

VARIOUS experimental tubes, 50¢ each, new 866's 95¢. W2AWZ.

CRYSTALS plus or minus 5 KC at 75¢ each. Faberadio, Sandwich, Ill.

1000 watt high-fidelity radiophone transmitter Collins audio-frequency equipment throughout. Response equal to excellent broadcast station. Easily capable of 2000 watts uses two bridge rectifiers for 3300 and 4400 volts with 5 k.w. transformers with perfect filtration. Superpower amateur transmitter together with Hammarlund Super-Pro receiver, bargain of the year for \$990. Delivery at station. First gets it. Edward Chinnock, Agent, 33 Elm Place, Red Bank, N. J.

SKYRIDER: 1936 model with crystal and tubes. First \$40 takes it. James Thorburn, Las Vegas, Nevada.

SELL: RME-69's \$99, ACR-175's \$79, SX11's \$69, RME9D's \$64, Breting 12's \$64, PR-16C's \$64, PR-10's \$39, ACR-136's \$39, Silver 5CX's \$39, Super Skyriders \$29, FBX's \$28, FB7's \$22, Tobe Brownings \$24, Sky Buddys \$19, Skyriders \$17.50, SW5's \$10, other sets. List free. All sets shipped on ten day trial. Send only \$5 with order. Bob Henry, W9ARA, Butler, Mo.

FOR Sale: transmitter, built by Frank Jones. Illustrated on Page 175 of 1936 Radio Handbook. Complete, tubes and crystal, no mike. WAC on CW. Australia on phone, \$160, cash f.o.b. Passaic, N. J. Chas. F. H. Johnson, Jr., 70 Heights Rd., Clifton, N. J., W2IUV.

SELL or trade—National SW3, Vibroplex, RK20, receiving tubes, hundreds surplus parts. Want miniature camera, enlarger, etc. All letters answered. Morgan H. Gravlee, W4AG, Kennedy, Ala.

WESTINGHOUSE DC generators, 2000 volts 1.5 amperes 1000 volts, 0.5 ampere. Chokes 2 amperes, 14 henries \$35. Meters four inch scale \$6. Transformer 220 to 110 volts, 1.5 kva. Five kw RCA tube \$20. Tube jackets. Janette converter 32 dc. to 110 ac 300 watts \$30. G. M. Watkins, Rt. 7, Nashville.

UNIVERSAL class B transformers—for use with all tubes. 50 watts audio \$4.95 pair—100 watts audio \$7.75 pair postpaid. Write for details. W8UD, Douglas, Mich.

SELL Acme Delta es other hi quality receiving es mitting equipment suitable for 10s or swap for good camera. Write for dope. W1IQA.

SPECIAL TO AMATEURS

Piezo-Electric Crystals — \$2.50 EACH POSTPAID

Until supply is exhausted . . . we offer small 80 meter band crystals unmounted; accurate calibration, excellent oscillators. Limited quantity.

SCIENTIFIC RADIO SERVICE

"The Crystal Specialists Since 1925." University Park, Hyattsville, Md.

LEARN TO SEND AND RECEIVE

CODE

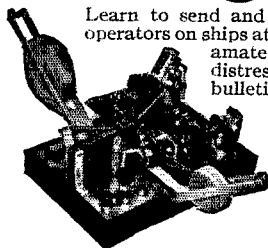

Learn to send and receive code signals, like operators on ships at sea and at commercial and amateur land stations. Intercept distress signals, news flashes, bulletins, and dozens of other kinds of interesting radio communications.

TELEPLEX teaches you to receive code exactly the way the world's best operators do — by sound. A heavy waxed paper tape, running

through a machine, operates an automatic key which sends messages to you, at any speed you desire. As you improve in speed, the machine sends faster, gradually preparing you for top-speed amateur and commercial signals. With the new All Electric MASTER TELEPLEX you learn to send by sending, and the signals you send are repeated back to you, exactly as you sent them, thus enabling you to correct your own errors. We furnish a complete course, lend you the All Electric MASTER TELEPLEX and give you personal instruction with a MONEY BACK GUARANTEE. Send for our new TELEPLEX FOLDER Q8 today. IT'S FREE!

TELEPLEX CO. 72-76 CORTLANDT STREET NEW YORK, N. Y.

TERMINAL APPOINTED EXCLUSIVE DISTRIBUTORS OF HARVEY TRANSMITTERS IN NEW YORK CITY AREA

Complete line on display

The 80-T TRANSMITTER

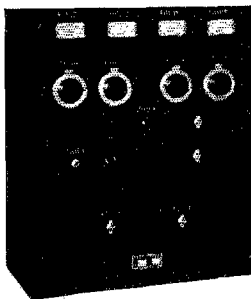

- COVERS ALL BANDS FROM 10-160 METERS ON PHONE AND C.W.
- COMPLETE METERING AND ADEQUATE CONTROLS
- COMPACTLY CONSTRUCTED, REQUIRES BUT LITTLE SPACE
- REASONABLY PRICED; MAY BE PURCHASED ON EASY PAYMENT PLAN

Write for literature

HARVEY UHX-10 TRANSMITTER

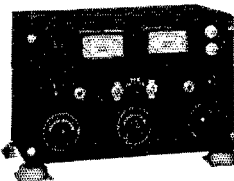

- 1,500-60,000 KC.
- PORTABLE
- MOBILE
- PHONE — CW-MCW
- 10 WATTS OUTPUT

See this rig in our store or write for information.

TAYLOR . . . TZ20 • 203Z

Priced at \$2.45 and \$8.50. Full information on these tubes is listed in the new Taylor manual — get your copy now at Terminal — IT'S FREE!

New! MALLORY VIBRAPACKS IN STOCK Perfect Portable Power FOR RADIO TRANSMITTERS

The new light-weight and portable (only 5½ lbs.) Vibrapack will supply up to 300 V. at 100 Ma. from a 6 volt storage battery.

THORDARSON MULTI-MATCH DRIVER and MODULATION TRANSFORMERS to match any combination of driver and output tubes.

Extra! AS ANNOUNCED IN THIS ISSUE

B. & W. Turret-type Transmitter coil switch in stock

TERMINAL RADIO CORP.
80 Cortlandt St. New York, N. Y.
BILL FILLER • ADOLPH GROSS

Your Nearest Dealer Is Your Best Friend

Your nearest dealer is entitled to your patronage. You can trust him. He is equipped with a knowledge and understanding of amateur radio. He is your logical and safe source of advice and counsel on what equipment you should buy. His stock is complete. He can supply your needs without delay. His prices are fair and consistent with the high quality of the goods he carries. He is responsible to you and interested in you.

Patronize the dealer nearest you—You can have confidence in him

ALLENTOWN, PENNSYLVANIA

Radio Electric Service Co.
1024 Hamilton Street
Complete stocks transmitting equipment

ATLANTA, GEORGIA

Wholesale Radio Service Company, Inc.
430 West Peachtree Street, N. W.
"Investigate Our Easy Payment Plan"

BALTIMORE, MARYLAND

Radio Electric Service Co.
3 N. Howard St.
Everything for the amateur

BRONX, NEW YORK

Wholesale Radio Service Company, Inc.
542 East Fordham Road
"Investigate Our Easy Payment Plan"

BUFFALO, NEW YORK

Radio Equipment Corp.
326 Elm Street
W80BK — Ham, service and sound equipment — W80LB

BUFFALO, NEW YORK

Dymac Radio
216 E. Genesee Street
Complete Line Ham and BCL Equipment Cl. 2080

JAMAICA, L. I.

Wholesale Radio Service Company, Inc.
90-08 166th Street (Merrick Road)
"Investigate Our Easy Payment Plan"

MONTREAL, CANADA

Canadian Elec. Supply Co., Ltd.
285 Craig St., W.
Quality parts and equipment for discriminating buyers

NEWARK, N. J.

Wholesale Radio Service Company, Inc.
219 Central Avenue
"Investigate Our Easy Payment Plan"

NEW YORK, N. Y.

Gross Radio, Inc.
51 Vesey Street
Fair dealings plus fair prices. Anything in radio

NEW YORK, N. Y.

Wholesale Radio Service Company, Inc.
100 Sixth Avenue
"Investigate Our Easy Payment Plan"

NEW YORK, N. Y.

Harrison Radio Company
12 West Broadway
"The Friendly Ham Supply House"

PHILADELPHIA, PENNSYLVANIA

Radio Electric Service Co., Inc.
N. E. Cor. Seventh & Arch Sts.
All nationally-advertised lines in stock

PHILADELPHIA, PENNSYLVANIA

Eugene G. Wile
10 S. Tenth Street
Complete Stock of Quality Merchandise

PROVIDENCE, RHODE ISLAND

W. H. Edwards Co.
32 Broadway
National, Taylor Tubes, Hallicrafters. Complete amateur supply house

PROVIDENCE, RHODE ISLAND

Kraus & Company
89 Broadway
Everything for the amateur and serviceman

RICHMOND, VIRGINIA

The Arnold Company
527 W. Broad Street
W3EHL—"The Virginia Ham Headquarters"—W3FBL

ROCHESTER, NEW YORK

Radio Service Shop
244 Clinton Avenue, North
Complete stock amateur-BCL parts. Standard discounts. W8NUC

SYRACUSE, NEW YORK

Roy C. Stage, W8IGF
Complete stock of standard Ham & BCL parts
Standard Discounts. Free technical service

SPRINGFIELD, MASS.

S. S. Kresge Company
1540 Main Street
Standard discounts, standard lines. Advisory service: W1JQ, W1FOF

You Are Protected When You Buy From QST Advertisers

“Advertising for QST is accepted only from firms who, in the publisher’s opinion, are of established integrity and whose products secure the approval of the technical staff of the American Radio Relay League.”

Quoted from QST’s advertising rate card.

Every conceivable need of a radio amateur can be supplied by the advertisers in QST. And you will know the product has the approval of the League’s technical staff.

For Your Convenience QST'S INDEX TO ADVERTISERS IN THIS ISSUE

Aerovox Corporation	90
Allen-Bradley Company	77
Astatic Microphone Laboratory	101
Barker & Williamson	71
Bellefonte Radio Eng. & Mfg. Co., Inc.	99
Birnback Radio Company	94
Bliley Electric Company	95
Bloom, H.	92
Brach Mfg. Co., L. S.	102
Brush Development Company	94
Burgess Battery Company	73
Candler System Company	78
Capitol Radio Engineering Institute	106
Cardwell Mfg. Corp., Allen D.	76
Centralab	79
Code-Craft	106
Cohen's Sons, Ltd., I. S.	97
Collins Radio Company	Cov. 2
Consolidated Radio Corporation	97
Cornell-Dubilier Corporation	99
Dodge's Institute	95
Eastern Radio Institute	106
Eitel-McCullough, Ltd.	81
Electro-Voice Mfg. Company	103
General Transformer Corporation	97
Gross Radio, Inc.	86
Gulf Radio School	103
Hallcrafters, Inc., The	1, 2
Hammarlund Mfg. Company	4
Harvey Radio Company	100
Harvey Radio Laboratories, Inc.	91
Heintz & Kaufman, Ltd.	87
Henry Radio Shop	91, 98
Hipower Crystal Company	106
Instructograph Company	95
Jensen Radio Mfg. Company	89
Johnson Company, E. F.	70
Kato Engineering Company	101
Kenyon Transformer Company, Inc.	92
Leads	82
Littelfuse Laboratories	99
Mallory & Company, Inc., P. R.	66, 74
Massachusetts Radio School	99
McElroy, F. R.	95
McGraw-Hill Book Company	80
Mims Radio Company	103
National Company	65, 99, Cov. 3
Newark Electric Company	83
Ohmite Manufacturing Company	97
Petersen Radio Company	103
Port Arthur College	101
Precision-Piezo Service	91
RCA Institutes, Inc.	91
RCA Manufacturing Company	Cov. 4
Radio Manufacturing Engineers, Inc.	111
Radio Shack	96
Radio Supply Company	93
Radio Transceiver Laboratories	102
Scientific Radio Service	108
Shure Brothers	90
Speer Carbon Company	95
Sun Radio Company	93
Taylor Tubes, Inc.	75
Teleplex Company	108
Terminal Radio Corporation	91, 108
Thordarson Elec. Mfg. Company	67
Triplet Electrical Instrument Co.	72
Turner Company	98
United Transformer Company	112
Utah Radio Products Corporation	87
Valpey Crystals, The	101
Vibroplex Company	101
Yaxley	66, 74

RME

SUMMER RECEPTION

Despite the usual adverse weather conditions, RME-69 owners are able to maintain their DX contacts and work new ones. With so many stations "on vacation," you will find that Summer is the best time of year to log those hard-to-get countries.

Literature on Request

**RADIO MFG. ENGINEERS
PEORIA, ILLINOIS**

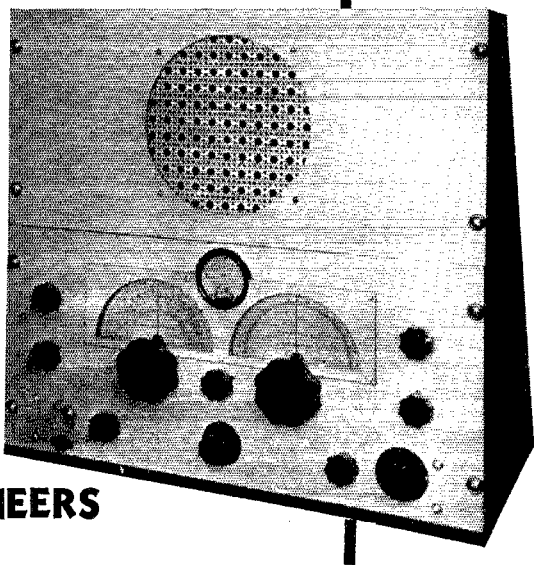

Say You Saw It in *QST* — It Identifies You and Helps *QST*

BELIEVE IT OR NOT

WITH APOLOGIES

UTC's leadership in transformer design is substantiated by the fact that some of the largest commercial organizations turn to UTC with their special transformer problems. Some of the more interesting units recently made by UTC for such organizations are almost in the "Believe It or Not" class.

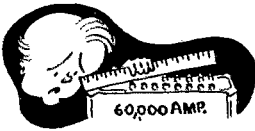

One organization* required a 60,000 AMP. transformer in a space approximately seven inch cube. Every other supplier contacted said "Impossible." **UTC MADE IT.**



Hum pickup on portable amplifiers and pre-amplifiers was the bugaboo of one communications organization.†

They are now buying UTC because, as their Engineering Department stated, "We wouldn't have believed it possible if we hadn't actually made complete laboratory tests." The input transformers supplied to this organization weigh only eighteen ounces. have a frequency characteristic uniform from 30 to 14,000 cycles, and a hum pickup 90 DB lower than similar units of standard construction.



A complete group of speech input and remote pickup amplifiers manufactured by one company.‡ were not usable due to high hum level.

UTC suggested the use of the LS-10X (tri-alloy shield) input transformer, which eliminated the problem completely.



One of the important elements in the "U. S. Safety in the Air" program involved a special filter for use on planes. The excessive weight of this filter made the system impractical.

UTC, however, reduced the weight from over thirty pounds to 3¼ pounds.



One of America's foremost radio comedians wanted to imitate the voice of America's foremost news announcer on his program.

The UTC 4 B sound effects filter made the job perfect.

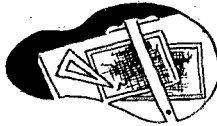

A special carrier frequency problem encountered by one company,** required a high power, air-cooled, audio transformer with 30,000 VOLTS insulation and frequency response good up to 150,000 CYCLES.

A unique transformer winding licked this problem.

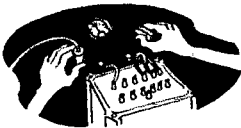

The use of high carrier frequencies for special communication service made necessary high power amplifier equipment for test service.

UTC designed the amplifier equipment for one organization* and supplied the audio transformers for service up to 100,000 CYCLES.

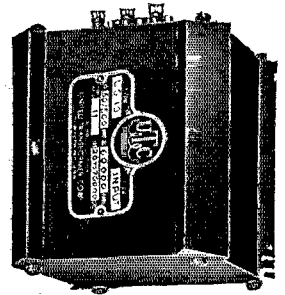

TO OUR KNOWLEDGE

- * The largest research organization in the world.
- † Largest radio receiver organization in the world.
- ** Largest radio communications company in the world.
- ‡ Largest electrical manufacturer in the world.

UNITED TRANSFORMER CORP.

72 SPRING STREET

NEW YORK, N. Y.

EXPORT DIVISION: 100 VARICK STREET NEW YORK, N. Y. CABLES: "ARLAB"

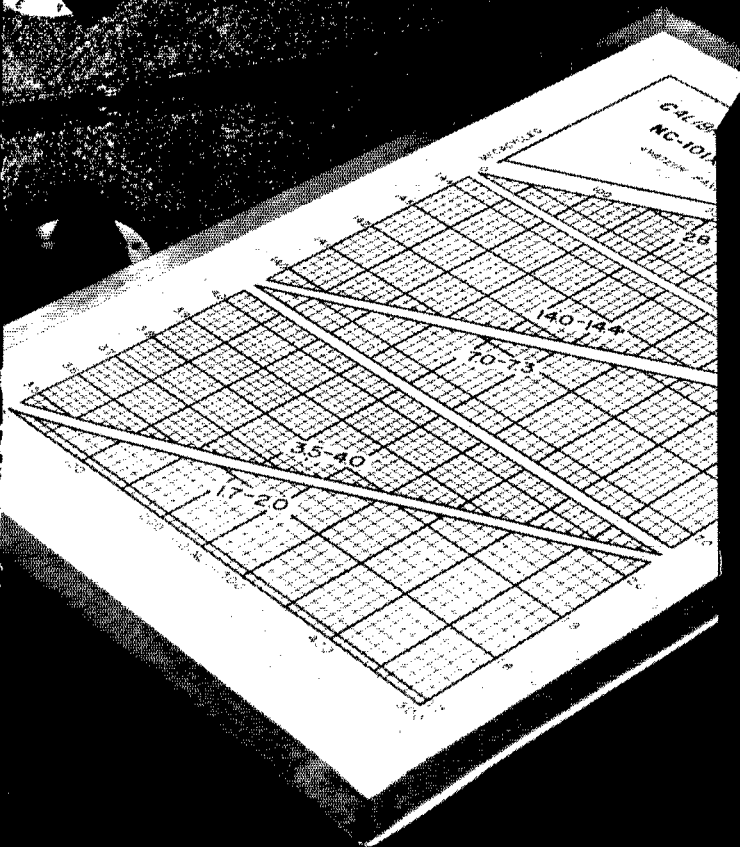

NC-101X

Every detail of the NC-101X is expressly designed for amateur communication receiver use. Its high precision micrometer dial, calibrated like a fine instrument, is typical of the comprehensive specialization that makes the performance of the NC-101X so outstanding.

**P
R
E
C
I
S
I
O
N**

Reap the Rewards of RCA Experience

...Buy RCA for Fine Quality...Top Performance!

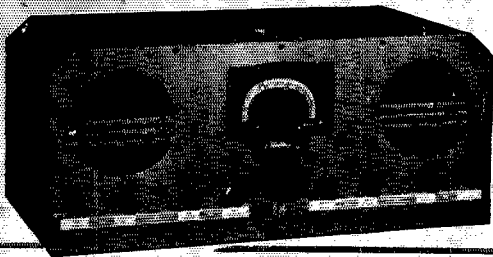

ACR-155—A moderately priced, 9-tube communications receiver covering from 520 to 22,000 kilocycles. Peak performance is assured by such RCA features as magnetite core i-f transformers and plunger-type air-dielectric trimmers. Price **\$74.50***

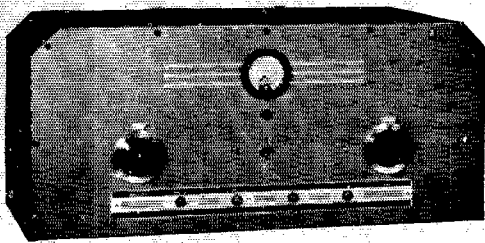

ACT-20—This new transmitter is winning widespread acclaim. Reports from owners prove its remarkable performance capabilities. Freedom from troubles, easy tuning, "broadcast quality" and assured performance are what owners like about the ACT-20. 20 watts C.W., 16 watts Phone output on all bands down to 10 meters at **\$129.50*** (less accessories) make the ACT-20 a real buy.

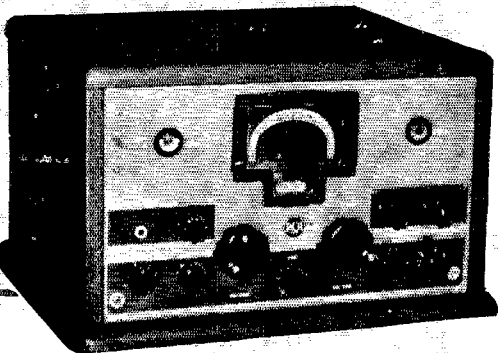

ACR-111—Including every worthwhile feature for communication service, this new receiver represents the last word in modern design. Of particular importance are the constant-percentage electrical bandspread system, noise suppressor, two r-f and i-f stages, exceptional sensitivity and signal-to-noise ratio. ACR-111 complete at **\$189.50***

*Amateur's net price f. o. b. factory

And don't forget RCA V-cut amateur crystals—a better crystal for those applications where only the best is good enough. 20 meter crystals of outstanding performance at no extra price. **\$9.85*** for amateur crystal and holder.



for Amateur Radio

AMATEUR RADIO SECTION

RCA Manufacturing Co., Inc., Camden, N. J. • A Service of the Radio Corporation of America